

Canon

HDV Camcorder
Instruction Manual

English

Caméscope HDV
Manuel d'instruction

Français

Cámara HDV
Manual de Instrucciones

Español

HV20

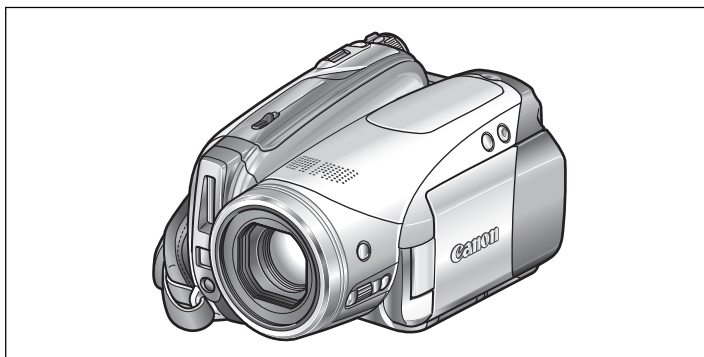

Mini **DV** Digital
Video
Cassette

HDV HDMI
HDV 1080i

PictBridge

Please read also the following instruction manual (electronic version on PDF file). For further details refer to the installation guide.

Veuillez lire aussi le manuel d'instruction suivant (version électronique sur fichier PDF). Pour d'autres détails référez-vous au guide d'installation.

Lea también el siguiente manual de instrucciones (versión electrónica en archivo PDF). Para mayores detalles, refiérase a la guía de instalación.

• **Digital Video Software**



NTSC

Important Usage Instructions

WARNING!



TO REDUCE THE RISK OF FIRE OR ELECTRIC SHOCK, DO NOT EXPOSE THIS PRODUCT TO RAIN OR MOISTURE.

WARNING!



TO REDUCE THE RISK OF ELECTRIC SHOCK AND TO REDUCE ANNOYING INTERFERENCE, USE THE RECOMMENDED ACCESSORIES ONLY.

COPYRIGHT WARNING:

Unauthorized recording of copyrighted materials may infringe on the rights of copyright owners and be contrary to copyright laws.

HDV Camcorder, HV20 A systems

This device complies with Part 15 of the FCC Rules. Operation is subject to the following two conditions: (1) This device may not cause harmful interference, and (2) this device must accept any interference received, including interference that may cause undesired operation.

Note: This equipment has been tested and found to comply with the limits for class B digital device, pursuant to Part 15 of the FCC Rules. These limits are designed to provide reasonable protection against harmful interference in a residential installation. This equipment generates, uses and can radiate radio frequency energy and, if not installed and use in accordance with the instructions, may cause harmful interference to radio communications. However, there is no guarantee that interference will not occur in a particular installation. If this equipment does cause harmful interference to radio or television reception, which can be determined by turning the equipment off and on, the user is encouraged to try to correct the interference by one or more of the following measures:

- Reorient or relocate the receiving antenna.
- Increase the separation between the equipment and receiver.
- Connect the equipment into an outlet on a circuit different from that to which the receiver is connected.
- Consult the dealer or an experienced radio/TV technician for help.

Use of shielded cable is required to comply with class B limits in Subpart B of Part 15 of FCC Rules.

Do not make any changes or modifications to the equipment unless otherwise specified in the manual.

If such changes or modifications should be made, you could be required to stop operation of the equipment.

Canon U.S.A. Inc.

One Canon Plaza, Lake Success, NY 11042, U.S.A.

Tel No. (516)328-5600

CAUTION:

TO PREVENT ELECTRIC SHOCK, MATCH WIDE BLADE OF PLUG TO WIDE SLOT, FULLY INSERT.

Important Warning



The lightning flash with arrowhead symbol, within an equilateral triangle, is intended to alert the user to the presence of uninsulated "dangerous voltage" within the product's enclosure, that may be of sufficient magnitude to constitute a risk of electric shock to persons.

CAUTION:

TO REDUCE THE RISK OF ELECTRIC SHOCK, DO NOT REMOVE COVER (OR BACK). NO USER-SERVICEABLE PARTS INSIDE. REFER SERVICING TO QUALIFIED SERVICE PERSONNEL.



The exclamation point, within an equilateral triangle, is intended to alert the user to the presence of important operating and maintenance (servicing) instructions in the literature accompanying the product.

IMPORTANT SAFETY INSTRUCTIONS

In these safety instructions the word “product” refers to the Canon HDV Camcorder HV20 A and all its accessories.

- 1** Read Instructions — All the safety and operating instructions should be read before the product is operated.
- 2** Retain Instructions — The safety and operating instructions should be retained for future reference.
- 3** Heed Warnings — All warnings on the product and in the operating instructions should be adhered to.
- 4** Follow Instructions — All operating and maintenance instructions should be followed.
- 5** Cleaning — Unplug this product from the wall outlet before cleaning. Do not use liquid or aerosol cleaners. The product should be cleaned only as recommended in this manual.
- 6** Accessories — Do not use accessories not recommended in this manual as they may be hazardous.
- 7** Avoid magnetic or electric fields — Do not use the camera close to TV transmitters, portable communication devices or other sources of electric or magnetic radiation. They may cause picture interference, or permanently damage the camera.
- 8** Water and Moisture — Hazard of electric shock — Do not use this product near water or in rainy/moist situations.
- 9** Placing or Moving — Do not place on an unstable cart, stand, tripod, bracket or table. The product may fall, causing serious injury to a child or adult, and serious damage to the product.
A product and cart combination should be moved with care. Quick stops, excessive force, and uneven surfaces may cause the product and cart combination to overturn.



- 10** Power Sources — The CA-570 Compact Power Adapter should be operated only from the type of power source indicated on the marking label. If you are not sure of the type of power supply to your home, consult your product dealer or local power company. Regarding other power sources such as battery power, refer to instructions in this manual.
- 11** Polarization — The CA-570 Compact Power Adapter is equipped with a polarized 2-prong plug (a plug having one blade wider than the other). The 2-prong polarized plug will fit into the power outlet only one way. This is a safety feature. If you are unable to insert the plug fully into the outlet, try reversing the plug. If the plug still fails to fit, contact your electrician to replace your obsolete outlet. Do not defeat the safety purpose of the polarized plug.
- 12** Power Cord Protection — Power cords should be routed so that they are not likely to be walked on or pinched by items placed upon or against them. Pay particular attention to plugs and the point from which the cords exit the product.
- 13** Outdoor Antenna Grounding — If an outside antenna is connected to the product, be sure the antenna is grounded so as to provide some protection against voltage surges and built-up static charges. Section 810 of the National Electrical Code, ANSI / NFPA No. 70—1984, provides information with respect to proper grounding of the mast and supporting structure, grounding of the lead-in wire to an antenna discharge unit, size of grounding conductors, location of antenna discharge unit, connection to grounding electrodes, and requirements for the grounding electrode. See figure 1.

Fig. 1 EXAMPLE OF ANTENNA GROUNDING AS PER NATIONAL ELECTRICAL CODE

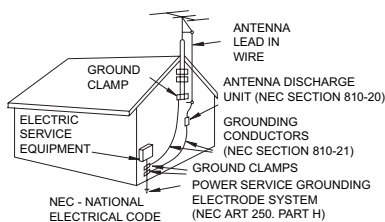

- 14** Lightning — For added protection of this product during a lightning storm, or when it is left unattended and unused for long periods of time, disconnect it from the wall outlet and disconnect the antenna. This will prevent damage to the product due to lightning and power-line surges.
- 15** Overloading — Do not overload wall outlets and extension cords as this can result in a risk of fire or electric shock.
- 16** Objects and Liquid Entry — Never push objects of any kind into this product through openings as they may touch dangerous voltage points or short out parts that could result in a fire or electric shock. Be careful not to spill liquid of any kind onto the product.
- 17** Servicing — Do not attempt to service this product yourself as opening or removing covers may expose you to dangerous voltage or other hazards. Refer all servicing to qualified service personnel.
- 18** Damage Requiring Service — Disconnect this product from the wall outlet and all power sources including battery, and refer servicing to qualified service personnel under the following conditions:
- When the power-supply cord or plug is damaged.
 - If any liquid has been spilled onto, or objects have fallen into, the product.
 - If the product has been exposed to rain or water.
 - If the product does not operate normally even if you follow the operating instructions. Adjust only those controls that are covered by the operation instructions. Improper adjustment of other controls may result in damage and will often require extensive work by a qualified technician to restore the product to its normal operation.
 - If the product has been dropped or the cabinet has been damaged.
 - When the product exhibits a distinct change in performance. This indicates a need for service.
- 19** Replacement Parts — When replacement parts are required, be sure the service technician has used replacement parts that are specified by Canon or that have the same characteristics as the original part. Unauthorized substitutions may result in fire, electric shock or other hazards.
- 20** Safety Check — Upon completion of any service or repairs to this product, ask the service technician to perform safety checks to determine that the product is in safe operating order.

When replacement of the power supply is required, please return it to the responsible nearest Canon Service Center and please replace it with the same type number CA-570.

The Adapter can be used with a power supply between 100 and 240 V AC. For areas where 120 V AC power is not used, you will need a special plug adapter. Contact your nearest Canon Service Center for further information.

This Class B digital apparatus complies with Canadian ICES-003.

Enjoying High-Definition Video

Preserve your most treasured memories, be it unforgettable scenery or cherished moments spent with family and friends, with high-definition video recordings of a quality second only to actually being there.

What is High-Definition Video?

High-definition video (HDV) allows you to record video of unparalleled high quality on regular miniDV tapes. HDV is composed of 1,080 horizontal lines—that is more than twice the number of horizontal lines and approximately 4 times the number of pixels in standard-definition TV broadcasts—resulting in eye-catching colors and richly detailed video recordings.



1,080 lines

How to play back your HDV recordings?

- On a high-definition TV (HDTV) (□ 67)
HDV recordings will be played back in their original high quality.
- On standard definition TVs (□ 68)
HDV recordings will be down-converted to match the resolution of the TV set.

What is the Cinema Mode?

Give your recordings a cinematic look by using the [CINE MODE] recording program (□ 45). Combine this recording mode with the high-definition, 24 fps progressive frame rate [HDV (PF24)] (□ 38) to get the enhanced effect of the 24p Cinema Mode.



Table of contents

Introduction

Enjoying High-Definition Video	5
About this Manual	9

Getting to Know the Camcorder

Supplied Accessories.....	11
Components Guide	12
Screen Displays	15

Preparations

Getting Started

Charging the Battery Pack	18
Inserting and Removing a Tape	20
Inserting and Removing a Memory Card	20
Preparing the Camcorder.....	21
The Wireless Controller	21
Adjusting the LCD Screen.....	22

Using the Menus

Selecting an Option from the FUNC. Menu	23
Selecting an Option from the Setup Menus	23

First Time Settings

Changing the Language.....	24
Changing the Time Zone.....	24
Setting the Date and Time	25

Basic Functions

Recording

Recording Movies	26
Recording Still Images	27
Zooming	28

Playback

Playing Back Movies	29
Adjusting the Volume: Speaker and Headphones.....	30
Locating the End of the Last Scene	32
Locating Scenes by Recording Date.....	32
Viewing Still Images	33
Magnifying the Playback Image	34

Advanced Functions

Menu Options Lists

FUNC. Menu Options.....	35
Setup Menus.....	37
Camera Setup (Digital Zoom, Image Stabilizer, etc.)	37
Recording/Video Input Setup (HD Standard, DV Recording Mode, etc.)	38
Card Operations (Initialization, Erase All Images, etc.)	40
Playback/Video Output Setup (Playback Standard, Component Video Out, DV Out etc.).....	40
Display Setup (LCD Brightness, Language, etc.)	43

System Setup (Beep, etc.)	44
Date/Time Setup	44
Recording Programs	
Using the Recording Programs	45
P Flexible Recording: Changing the Aperture and Shutter Speed.....	46
Special Scene: Recording Programs to Match Special Conditions	47
Adjusting the Picture: Exposure, Focus and Color	
Manual Exposure Adjustment and Automatic Backlight Correction	48
Manual Focus Adjustment	49
Focus Assist Functions.....	50
White Balance	50
Image Effects.....	51
Still Image Recording Options	
Selecting the Size and Quality of Still Images	52
Capturing a Still Image while Recording Movies	53
Light Metering Mode.....	54
Automatic Focus Priority.....	55
Continuous Shooting and Exposure Bracketing	56
Other Functions	
On-Screen Displays.....	57
Flash.....	58
Mini Video Light	59
Self Timer	60
Audio Recording Level	60
Digital Effects.....	62
Editing Functions	
Still Image Options	
Erasing Still Images	64
Protecting Still Images	64
Initializing the Memory Card	65
External Connections	
Connecting to a TV or VCR	
Connection Diagrams	66
Playback on a TV Screen	69
Recording to a VCR or Digital Video Recorder	70
Analog Line-In Recording	71
Digital Video Dubbing	72
Analog/Digital Conversion	73
Connecting to a Computer	
PC Connection Diagrams	75
Transferring Video Recordings	76
Transferring Still Images – Direct Transfer	77
Transfer Orders	78
Connecting to a Printer	
Printing Still Images – Direct Print	79
Selecting the Print Settings	80
Trimming Settings.....	82
Print Orders	82

Additional Information

Trouble?

Troubleshooting	84
List of Messages	88

Do's and Don'ts

Handling Precautions	91
Maintenance/Others	94
Cleaning the Video Heads	94
Using the Camcorder Abroad	95

General Information

System Diagram	96
Optional Accessories	97
Product Codes	100
Specifications	101
Index	103



Trademark Acknowledgements

- miniSD™ is a trademark of SD Card Association.
- Windows® is a registered trademark of Microsoft Corporation in the United States and/or other countries.
- Macintosh and Mac OS are trademarks of Apple Computer, Inc., registered in the United States and other countries.
- Mini **DN** is a trademark.
- HDV and the HDV logo are trademarks of Sony Corporation and Victor Company of Japan, Ltd. (JVC).
- HDMI, the HDMI logo and High-Definition Multimedia Interface are trademarks or registered trademarks of HDMI Licensing LLC.
- Other names and products not mentioned above may be trademarks or registered trademarks of their respective companies.
- ANY USE OF THIS PRODUCT OTHER THAN CONSUMER PERSONAL USE IN ANY MANNER THAT COMPLIES WITH THE MPEG-2 STANDARD FOR ENCODING VIDEO INFORMATION FOR PACKAGED MEDIA IS EXPRESSLY PROHIBITED WITHOUT A LICENSE UNDER APPLICABLE PATENTS IN THE MPEG-2 PATENT PORTFOLIO, WHICH LICENSE IS AVAILABLE FROM MPEG LA, L.L.C., 250 STEELE STREET, SUITE 300, DENVER, COLORADO 80206.

About this Manual

Thank you for purchasing the Canon HV20. Please read this manual carefully before you use the camcorder and retain it for future reference. Should your camcorder fail to operate correctly, refer to the *Troubleshooting* table (□ 84).

Conventions Used in the Manual

-  **IMPORTANT:** Precautions related to the camcorder operation.
-  **NOTES:** Additional topics that complement the basic operating procedures.
-  **POINTS TO CHECK:** Restrictions that apply if the function described is not available in all operating modes (the operating mode to which the camcorder should be set, etc.).
- □ : Reference page number.
- “Screen” refers to the LCD and the viewfinder screen.
- The photos included in the manual are simulated pictures taken with a still camera.

Menu item shown at its default position _____

Buttons and switches to be operated _____

Brackets [] and capital letters are used to refer to menu options as they are displayed on screen. Menu options in boldface indicate the default setting (for example **[ON]**, [OFF]).

Names of buttons and switches other than the joystick are indicated within a “button” frame (for example **[FUNC.]**).

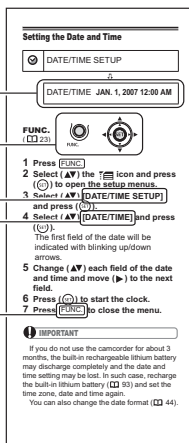

About the Joystick and the Joystick Guide

The mini joystick allows you to control many of the camcorder's operations and to make selections and changes in the camcorder's menus.

Push the joystick up, down, left or right (▲▼, ◀▶) to select an item or change settings.



Press the joystick itself (SET) to save the settings or confirm an action. On menu screens, this is indicated by the SET icon (SET).

The functions assigned to the joystick change according to the operation mode and the camcorder's settings. Press (SET) to display/hide the joystick guide to remind you of the joystick's functions.









When the guide contains multiple 'pages', [NEXT] and the page number icon (✓) will appear at the bottom position. Push the joystick (▼) toward [NEXT] to display the next 'page' of the guide.

About the Operating Modes

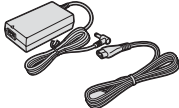
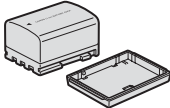
The camcorder's operating mode is determined by the positions of the POWER switch and the [CAMERA] / [PLAY] switch. In the manual, [CAMERA] indicates that a function is available in the operating mode shown and [PLAY] indicates that the function is not available. When no operating mode icons are given, the function is available in all operating modes.

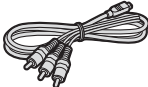
Operating Mode	POWER Switch	[CAMERA] / [PLAY] Switch	Icon Display	Operation	
		(Tape)		Recording movies on the tape	26
	CAMERA	(Memory card)		Recording still images on the memory card	27
		(Tape)		Playing movies from the tape	29
	PLAY	(Memory card)		Viewing still images from the memory card	33

Supplied Accessories

<p>CA-570 Compact Power Adapter (incl. power cord)</p> 	<p>BP-2L13 Battery Pack</p> 	<p>WL-D87 Wireless Controller</p> 	<p>Lithium Button Battery CR2025 for Wireless Controller</p> 
<p>CTC-100/S Component Cable</p>  <p>Red • Green • Blue plugs</p>	<p>STV-250N Stereo Video Cable</p>  <p>Yellow • Red • White plugs</p>	<p>IFC-300PCU USB Cable</p> 	<p>DIGITAL VIDEO SOLUTION DISK Software CD-ROM*</p> 

* Includes the electronic version of the *Digital Video Software* instruction manual on PDF file.

Online product registration for U.S.A. Customers only.

Register your product online at www.registercanon.com

✓ **Protect your product**

We will keep the model number and date of purchase of your new Canon product on file to help you refer to this information in the event of an insurance claim such as loss or theft.

✓ **Receive information on new products and promotions**

Upon your request, we will send you information on Canon new products and promotions.

The serial number of this product can be found at the battery attachment unit of the camcorder. Write down the number and other information here and retain this book as a permanent record of your purchase to aid identification in case of theft.

Date of Purchase:

Model Name: HV20 A

Purchased From:

Serial No.:

Dealer Address:

Dealer Phone No.:

Components Guide

Left side view

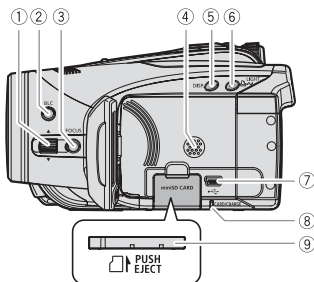

Right side view

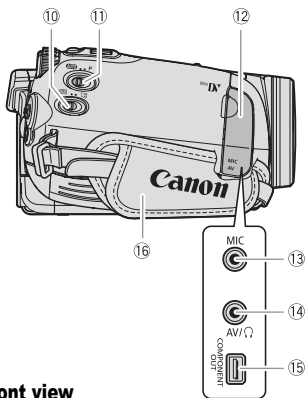

Front view

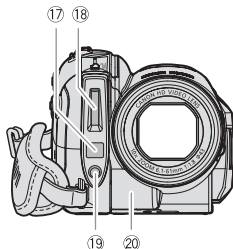

- ① FOCUS lever ([] 49)
- ② BLC (backlight correction) button ([] 48)
- ③ FOCUS button ([] 49, 50)
- ④ Speaker
- ⑤ DISP. (display) button ([] 57)/
LCD backlight button (long press) ([] 22)
- ⑥ LIGHT button ([] 59)/
[] [] (print/share) button ([] 77, 80)
- ⑦ USB terminal ([] 75)
- ⑧ CARD access indicator ([] 27)/
CHARGE indicator ([] 18)
- ⑨ Memory card slot ([] 20)
- ⑩ [] / [] (tape/card) switch ([] 10)
- ⑪ Mode switch ([] 45)
- ⑫ Terminal cover
- ⑬ MIC (microphone) terminal ([] 61)
- ⑭ AV terminal ([] 66)/
[] (headphones) terminal ([] 30)
- ⑮ COMPONENT OUT terminal ([] 66)
- ⑯ Grip belt ([] 21)
- ⑰ Instant AF sensor ([] 37)
- ⑱ Flash ([] 58)
- ⑲ Mini video light ([] 59)
- ⑳ Remote sensor ([] 21)

Names of buttons and switches other than the joystick are indicated within a "button" frame (for example [FUNC.]).

Back view

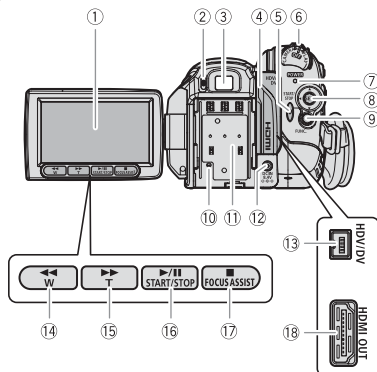

Top view

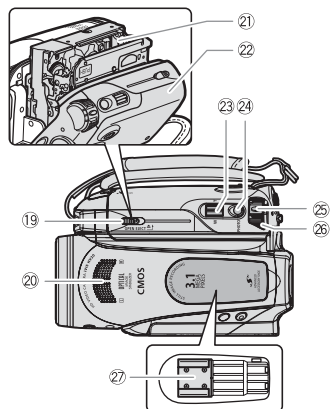

Bottom view

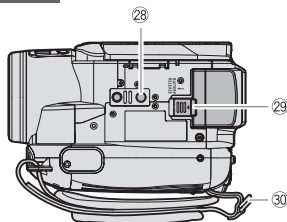

- ① LCD screen (22)
- ② Dioptic adjustment lever (21)
- ③ Viewfinder (21)
- ④ Terminal cover
- ⑤ START/STOP button (26)
- ⑥ POWER switch (10)
- ⑦ Power indicator (10)
- ⑧ Joystick (10)
- ⑨ FUNC. button (23, 35)
- ⑩ RESET button (84)
- ⑪ Serial number/Battery attachment unit (18)
- ⑫ DC IN terminal (18)
- ⑬ HDV/DV terminal (66, 75)
- ⑭ ◀◀ (rewind) button (29)/
Zoom out **W** (wide-angle) button (28)
- ⑮ ▶▶ (fast forward) button (29)/
Zoom in **T** (telephoto) button (28)
- ⑯ ▶/|| (play/pause) button (29)/
START/STOP button (26)
- ⑰ ■ (stop) button (29)/
FOCUS ASSIST button (50)
- ⑱ HDMI IN terminal (66, 69)
- ⑲ OPEN/EJECT ▲ switch (20)
- ⑳ Stereo microphone
- ㉑ Cassette compartment (20)
- ㉒ Cassette compartment cover (20)
- ㉓ Zoom lever (28)
- ㉔ PHOTO button (27)
- ㉕ Lock button
- ㉖ POWER switch (10)
- ㉗ Advanced accessory shoe (59, 61)
- ㉘ Tripod socket (27)
- ㉙ BATTERY RELEASE switch (18)
- ㉚ Strap mount

Names of buttons and switches other than the joystick are indicated within a "button" frame (for example [FUNC.]).





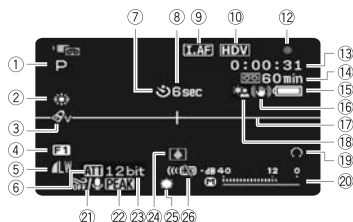



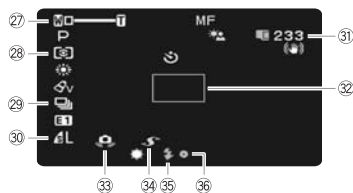

























Screen Displays

CAMERA Recording Movies



CAMERA Recording Still Images



- ① Recording program ( 45)
- ② White balance ( 50)
- ③ Image effect ( 51)
- ④ Digital effects ( 62)
- ⑤ Still image quality/size (simultaneous recording) ( 53)
- ⑥ Microphone attenuator ( 60)
- ⑦ Self timer ( 60)
- ⑧ Recording reminder
- ⑨ Instant AF ( 37)/Manual focus ( 49)
- ⑩ Recording standard (HDV or DV) ( 38)
- ⑪ DV recording mode ( 39)
- ⑫ Tape operation
- ⑬ Time code (hours : minutes : seconds)
- ⑭ Remaining tape
- ⑮ Remaining battery charge
- ⑯ Image stabilizer ( 38)
- ⑰ Level marker ( 43)
- ⑱ Backlight correction ( 48)
- ⑲ Headphones output ( 30)
- ⑳ Audio level indicator (microphone) ( 60)
- ㉑ Wind screen off ( 39)
- ㉒ Focus assist functions ( 50)
- ㉓ DV audio mode ( 39)
- ㉔ Condensation warning ( 94)
- ㉕ Mini video light ( 59)
- ㉖ Remote sensor off ( 44)
- ㉗ Zoom ( 28), Exposure  ( 48)
- ㉘ Light metering mode ( 54)
- ㉙ Drive mode ( 56)
- ㉚ Still image quality/size ( 52)
- ㉛ Number of still images available on the memory card
- ㉜ AF frame ( 55)
- ㉝ Camcorder shake warning ( 37)
- ㉞ Advanced accessory shoe  ( 96)
- ㉟ Flash ( 58)
- ㊱ Autofocus (AF) and exposure (AE) locked ( 27)

⑧ Recording reminder

The camcorder counts from 1 to 10 seconds when you start recording. This is helpful to avoid scenes that are too short.

⑫ Tape operation

- Record, ● || Record pause,
- Stop, ▲ Eject,
- ▶▶ Fast forward, ◀◀ Rewind,
- ▶ Playback, ▶ || Playback pause,
- || ◀ Reverse playback pause,
- x1 ▶ Playback (normal speed),
- ◀x1 Reverse playback (normal speed),
- x2 ▶ Playback (double speed),
- ◀x2 Reverse playback (double speed),
- ▶▶ Fast forward playback,
- ◀◀ Rewind playback,
- ▶ Slow playback,
- ◀ Slow reverse playback,
- ||▶ Frame advance,
- ◀|| Frame reverse,
- ◀◀/▶▶ Date search (📅 32),
- ◀◀/▶▶ Zero set memory (📅 31)

⑭ Remaining tape

Indicates the remaining time of the tape in minutes. "📅" moves during recording. When the tape reaches its end, the display changes to "📅 END".

- When the time left is less than 15 seconds, the remaining tape time may not appear.
- Depending on the type of the tape, the remaining time displayed may not be correct. In any case, you will be able to record on the tape the number of minutes that appears on the videocassette's label (for example, 85 minutes).

⑮ Remaining battery charge



- When "🔋" starts flashing in red, replace the battery pack with a fully charged one.
- When you attach an empty battery pack, the power may turn off without displaying "🔋".
- Depending on the conditions under which the camcorder and the battery pack are used, the actual battery charge may not be indicated accurately.

⑰ Number of still images available on the memory card

Depending on the recording conditions, the number of still images available displayed may not decrease even after a recording has been made, or may decrease by 2 still images at once.

Card Access Display

"▶ 📄" is displayed next to the number of images available while the camcorder is writing on the memory card.

PLAY **Playing Movies**



- ① Tape operation
- ② Time code (hours : minutes : seconds : frames)
- ③ Remaining tape
- ④ Data code (57)
- ⑤ Search function display
END SEARCH (32/
DATE SEARCH (32)
- ⑥ Quality/size for capturing still images (54)
- ⑦ Audio level indicator (60)

PLAY **Viewing Still Images**

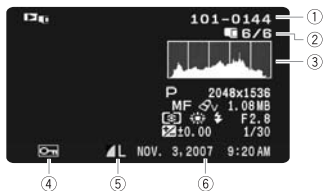

- ① Image number (40)
- ② Current image / Total number of images
- ③ Histogram (58)
- ④ Image protection mark (64)
- ⑤ Still image quality/size
- ⑥ Date and time of recording
- ⑦ Recording program (45)
- ⑧ Manual focus (49)
- ⑨ Light metering mode (54)
- ⑩ Manual exposure (48)
- ⑪ Image effect (51)
- ⑫ Image size (52)
- ⑬ File size
- ⑭ Aperture value (46)
- ⑮ Shutter speed (46)
- ⑯ White balance (50)
- ⑰ Flash (58)

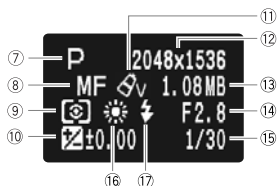

Getting Started

Charging the Battery Pack

The camcorder can be powered with a battery pack or directly using the compact power adapter. Charge the battery pack before use.

Remove the battery terminal cover before attaching the battery pack

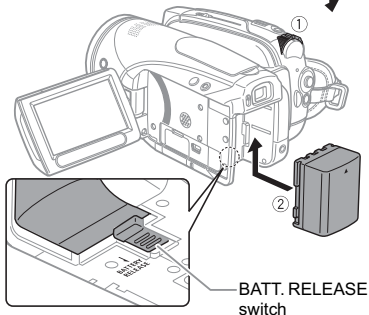
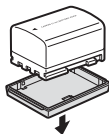

- 1 Turn off the camcorder.
- 2 Attach the battery pack to the camcorder.

Press the battery pack softly into the battery attachment unit and slide it up until it clicks in place.

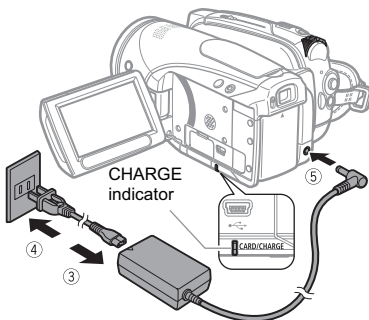

- 3 Connect the power cord to the compact power adapter.
- 4 Plug the power cord into a power outlet.
- 5 Connect the compact power adapter to the camcorder's DC IN terminal.
 - The CHARGE indicator starts flashing. The indicator will stay on when the charging is completed.
 - You can also use the compact power adapter without attaching a battery pack.
 - When the compact power adapter is connected, even if a battery is attached its power will not be consumed.

ONCE THE BATTERY PACK IS FULLY CHARGED

- 1 Disconnect the compact power adapter from the camcorder.
- 2 Unplug the power cord from the power outlet and the compact power adapter.

TO REMOVE THE BATTERY PACK

Slide **BATTERY RELEASE** in the direction of the arrow and hold it pressed down. Slide the battery pack down and then pull it out.

IMPORTANT

- You may hear some noise from the compact power adapter during use. This is not a malfunction.
- We recommend charging the battery pack in temperatures between 10 °C and 30 °C (50 °F and 86 °F). Outside the temperature range of 0 °C to 40 °C (32 °F to 104 °F), the charging will not start.
- Do not connect to the camcorder's DC IN terminal or to the compact power adapter any electrical equipment that is not expressly recommended for use with this camcorder.
- To prevent equipment breakdowns and excessive heating, do not connect the supplied compact power adapter to voltage converters for

overseas travels or special power sources such as those on aircraft and ships, DC-AC inverters, etc.

i NOTES

- The CHARGE indicator also serves as a rough estimate of the battery charge status. Continuously on: Battery fully charged. Flashes approx. twice per second: Battery over 50% charged. Flashes approx. once per second: Battery less than 50% charged.
- The charging time will vary depending on the surrounding temperature and the battery pack's initial charge condition. In cold places, the effective usage time of the battery will decrease.

- We recommend that you prepare battery packs 2 to 3 times longer than you think you might need.

● **U.S.A. and Canada only:** The lithium ion/polymer battery that powers this product is recyclable. Please call 1-800-8-BATTERY for information on how to recycle this battery.



Charging, Recording and Playback Times

The times given in the table below are approximate and vary depending on the actual charging, recording or playback conditions.

Battery Pack	NB-2LH	BP-2L13	BP-2L14
Charging Time	130 min.	200 min.	225 min.
(HDV) Maximum Recording Time			
Viewfinder	70 min.	120 min.	150 min.
LCD [NORMAL]	65 min.	115 min.	140 min.
LCD [BRIGHT]	65 min.	110 min.	135 min.
Typical Recording Time*			
Viewfinder	40 min.	75 min.	85 min.
LCD [NORMAL]	35 min.	70 min.	80 min.
LCD [BRIGHT]	35 min.	65 min.	80 min.
Playback Time	85 min.	145 min.	175 min.
(DV) Maximum Recording Time			
Viewfinder	80 min.	140 min.	165 min.
LCD [NORMAL]	75 min.	135 min.	155 min.
LCD [BRIGHT]	75 min.	125 min.	150 min.
Typical Recording Time*			
Viewfinder	45 min.	80 min.	95 min.
LCD [NORMAL]	45 min.	75 min.	90 min.
LCD [BRIGHT]	40 min.	75 min.	85 min.
Playback Time	95 min.	165 min.	195 min.

* Approximate times for recording with repeated operations such as start/stop, zooming, power on/off.

Inserting and Removing a Tape

Use only videocassettes marked with the Mini DV logo. To record in HDV standard we recommend using tapes specifically designed for high definition.

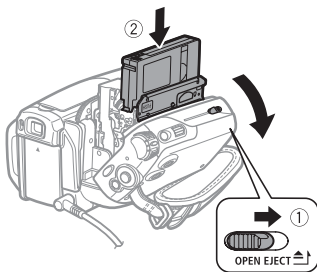

1 Slide **OPEN/EJECT** fully in the direction of the arrow and open the cassette compartment cover.

The cassette compartment opens automatically.

2 Insert the cassette.

- Insert the cassette with the window facing the grip belt.
- To remove the cassette pull it straight out.

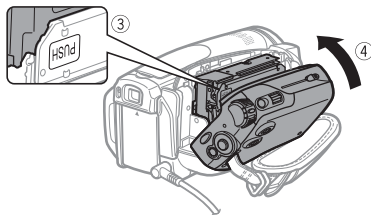

3 Press the **PUSH** mark on the cassette compartment until it clicks.

4 Wait for the cassette compartment to retract automatically and close the cassette compartment cover.

IMPORTANT

- Do not interfere with the cassette compartment while it is opening or closing automatically, or attempt to close the cover before the cassette compartment has fully retracted.
- Be careful not to get your fingers caught in the cassette compartment cover.

NOTES

If the camcorder is connected to a power source, cassettes can be inserted/removed even if the **POWER** switch is set to **OFF**.

Inserting and Removing a Memory Card

Use only commercially available miniSD cards.

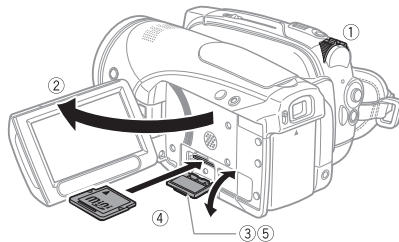

1 Turn off the camcorder.

2 Open the LCD panel.

3 Open the memory card slot cover.

4 Insert the memory card straight with the “miniSD” label facing up, all the way into the memory card slot until it clicks.

5 Close the cover.

Do not force the cover closed if the memory card is not correctly inserted.

TO REMOVE THE MEMORY CARD

First push the memory card once to release it, and then pull the card out.

! IMPORTANT

- Make sure to initialize all memory cards before using them with this camcorder for the first time (□ 65).
- Memory cards have front and back sides that are not interchangeable. Inserting a memory card facing the wrong direction can cause a malfunction of the camcorder.

i NOTES

Proper operation cannot be guaranteed for all miniSD cards.

Preparing the Camcorder

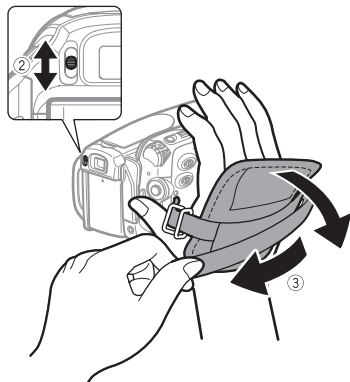

- 1 Turn on the camcorder.**
The lens cover will open automatically.
- 2 Adjust the viewfinder.**
Keep the LCD panel closed to use the viewfinder and adjust the dioptic adjustment lever as necessary.
- 3 Fasten the grip belt.**
Adjust the grip belt so that you can reach the zoom lever with your index finger, and the START/STOP button with your thumb.

The Wireless Controller

Inserting the Battery

(Lithium Button Battery CR2025)

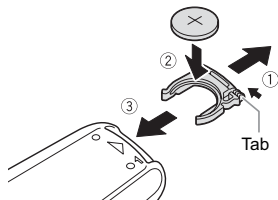

- 1 Press the tab in the direction of the arrow and pull out the battery holder.**
- 2 Place the lithium button battery with the + side facing up.**
- 3 Insert the battery holder.**

Using the Wireless Controller

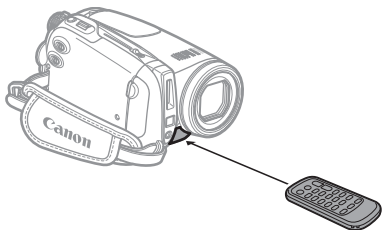

Point the controller at the camcorder's remote sensor when you press the buttons.

i NOTES

- The wireless controller may not work properly when the remote sensor is situated under strong light sources or direct sunlight.
- If the wireless controller does not work, check that [WL.REMOTE] is not set to [OFF (OFF)] (□ 44). Otherwise, replace the battery.

Adjusting the LCD Screen

Rotating the LCD Panel

Open the LCD panel 90 degrees.

You can rotate the panel 90 degrees downward.

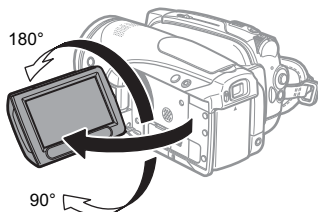

You can rotate the panel 180 degrees toward the lens (allowing the subject to monitor the LCD screen while you use the viewfinder). Rotating the panel 180 degrees is also useful if you wish to include yourself when recording with the self timer.

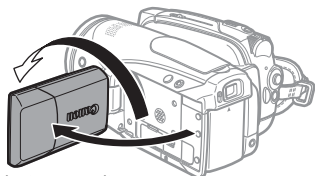

Subject can monitor the LCD screen

LCD Backlight

You can set the brightness of the LCD screen to normal or bright.

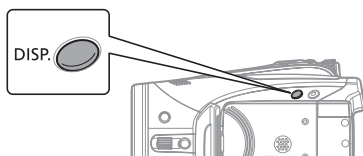

Hold **DISP.** pressed down for more than 2 seconds.

Repeat this action to toggle between the normal and bright settings.

i NOTES

- This setting does not affect the brightness of the recording or the viewfinder screen.
- Using the bright setting will shorten the effective usage time of the battery pack.
- You can also adjust the brightness of the LCD from the menu (☐ 43).

Using the Menus

Many of the camcorder's functions can be adjusted from the menus that open after pressing the FUNC. button (FUNC.). For details about the available menu options and settings, refer to *Menu Options Lists* (□ 35).

Selecting an Option from the FUNC. Menu

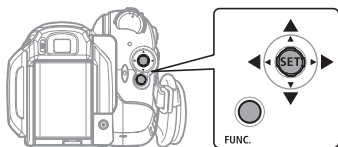

- 1 Press **FUNC.**.
- 2 Select (▲▼) the icon of the function you want change from the left side column.
- 3 Select (◀▶) the desired setting from the available options at the bottom bar.
The selected option will be highlighted in light blue. Menu items not available will appear grayed out.
- 4 Press **FUNC.** to save the settings and close the menu.
 - You can press **FUNC.** to close the menu at any time.
 - With some settings you will need to press (SET) and make further selections. Follow the additional operation guides that will appear on

the screen (such as the **SET** icon, small arrows, etc.).

Selecting an Option from the Setup Menu

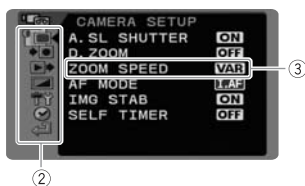
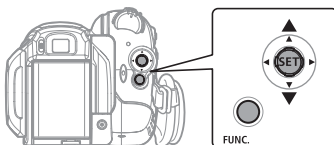

- 1 Press **FUNC.**.
- 2 Select (▲) the  icon and press (SET) to open the setup menus. You can also hold **FUNC.** pressed down for more than 1 second to open directly the setup menu screen.
- 3 Select (▲▼) the desired menu from the left side column and press (SET). The title of the selected menu appears on top of the screen and under it the list of settings.
- 4 Select (▲▼) the setting you want to change and press (SET).
 - An orange frame will indicate the menu item currently selected. Menu items not available will appear grayed out.
 - To return to the menu selection screen, select (▼) [↩ RETURN] and press (SET).
- 5 Select (▲▼) the desired option and press (SET) to save the setting.
- 6 Press **FUNC.**. You can press **FUNC.** to close the menu at any time.

First Time Settings

Changing the Language

Options



◆ Default value



LANGUAGE ENGLISH◆

FUNC.
(23)



- 1 Press **FUNC.**.
- 2 Select (▲▼) the ☺ icon and press (SET) to open the setup menus.
- 3 Select (▲▼) [DISPLAY SETUP/☺] and press (SET).
- 4 Select (▲▼) [LANGUAGE] and press (SET).
- 5 Select (▲▼, ◀▶) the desired option and press (SET).
- 6 Press **FUNC.** to close the menu.

i NOTES

- If you changed the language by mistake, follow the ☺ mark next to the menu item to change the setting.
- The displays **SET** and **FUNC.** that appear in some menu screens refer to the name of buttons on the camcorder and will not change, regardless of the language selected.

Changing the Time Zone

◆ Default value



T.ZONE/DST NEW YORK◆

FUNC.
(23)



- 1 Press **FUNC.**.
- 2 Select (▲▼) the ☺ icon and press (SET) to open the setup menus.
- 3 Select (▲▼) [DATE/TIME SETUP] and press (SET).
- 4 Select (▲▼) [T.ZONE/DST] and press (SET).
The time zone setting appears. The default setting is New York.
- 5 Select (▲▼) your time zone and press (SET).
To adjust for daylight saving time, select the time zone with the ⚙ mark next to the area.
- 6 Press **FUNC.** to close the menu.

Time Zones

Once you have set the time zone, date and time, you do not need to reset the clock every time you travel to another time zone. Select the time zone referring to the date and time displayed on the screen.

Setting the Date and Time

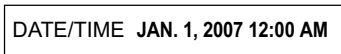

FUNC.
(23)



- 1 Press **FUNC.**
- 2 Select (**▲▼**) the icon and press (**SET**) to open the setup menus.
- 3 Select (**▲▼**) **[DATE/TIME SETUP]** and press (**SET**).
- 4 Select (**▲▼**) **[DATE/TIME]** and press (**SET**).
The first field of the date will be indicated with blinking up/down arrows.
- 5 Change (**▲▼**) each field of the date and time and move (**▶**) to the next field.
- 6 Press (**SET**) to start the clock.
- 7 Press **FUNC.** to close the menu.

IMPORTANT

- If you do not use the camcorder for about 3 months, the built-in rechargeable lithium battery may discharge completely and the date and time setting may be lost. In such case, recharge the built-in lithium battery (93) and set the time zone, date and time again.
- You can also change the date format (44).

Recording

Recording Movies

Before You Begin Recording

Make a test recording first to check if the camcorder operates correctly. If necessary, clean the video heads (□ 94).

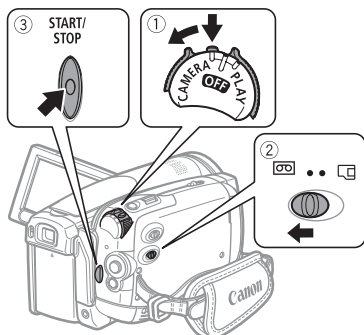

1 Holding the lock button pressed down, set the **POWER** switch to **CAMERA**.

2 Move the / switch to (tape).

If necessary, you can change the recording standard (HDV or DV) (□ 38).

3 Press **START/STOP** to begin recording.

Press **START/STOP** again to pause the recording.

TO REVIEW THE LAST SCENE RECORDED

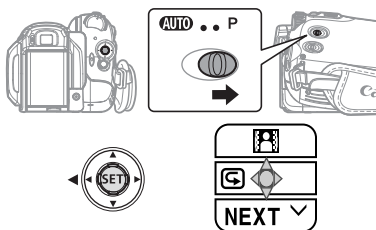

- 1** Set the mode switch to **P**.
- 2** If the joystick guide does not appear on screen, press **(SET)** to display it.
- 3** Push the joystick () toward **(NEXT)**.
 - If **(NEXT)** does not appear on the joystick guide, repeatedly push the joystick () toward **[NEXT]** to display the joystick guide in the illustration above.
 - The camcorder will play back a few seconds of the last recording made and return to record pause mode. If the currently selected recording standard is different from that of the last recording, the picture may not be played back correctly.

WHEN YOU HAVE FINISHED RECORDING

- 1** Close the LCD panel.
- 2** Turn off the camcorder.
- 3** Remove the tape.
- 4** Disconnect the power source and remove the battery pack.

NOTES

- Previous recordings overwritten by a new recording cannot be recovered. Before you start recording, search for the end of the last recording (□ 32).
- To protect the tape and video heads, the camcorder will enter the stop mode () if left in record pause () mode for 4 minutes 30 seconds. To resume recording press **START/STOP**.
- When recording in very loud places (such as fireworks shows or concerts), sound may

become distorted or it may not be recorded at the actual levels. This is not a malfunction.

● **About the Power Save mode:** To save power when the camcorder is powered by a battery pack, the camcorder will automatically shut off if left without any operations for 5 minutes (☐ 44). To restore the power, turn the camcorder off and then on again.

● **About the LCD and viewfinder screen:** The screens are produced using extremely high-precision manufacturing techniques, with more than 99.99% of the pixels operating to specification. Less than 0.01% of the pixels may occasionally misfire or appear as black, red, blue or green dots. This has no effect on the recorded image and does not constitute a malfunction.

● **When using a tripod:** Do not leave the viewfinder exposed to direct sunlight as it may melt (due to concentration of the light by the lens). Do not use tripods with fastening screws longer than 5.5 mm (0.2 in.). Doing so may damage the camcorder.

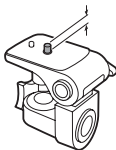

● **When recording movies, try to get a calm, stable picture.**

Excessive camcorder movement while shooting and extensive use of fast zooms and panning can result in jittery scenes. In extreme cases, the playback of such scenes may result in visually induced motion sickness. If you experience such a reaction, immediately stop the playback and take a rest break as necessary.

Recording Still Images

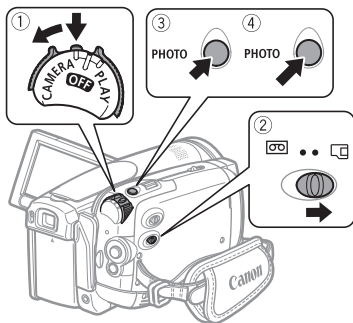

Before using a memory card for the first time, be sure to initialize it with this camcorder (☐ 65).



- Holding the lock button pressed down, set the **POWER** switch to **CAMERA**.**
- Move the **☐/☐** switch to **☐** (memory card).**
- Press **PHOTO** halfway.**
 - Once the focus is automatically adjusted, ● will turn green and one or more AF frames will appear.
 - When you press **PHOTO** on the wireless controller, the still image is recorded immediately.
- Press **PHOTO** fully.**
The **CARD** access indicator will flash as the image is being recorded.

! IMPORTANT

Avoid the following actions while the card access display (▶ ) appears on screen and when the CARD access indicator is on or flashing. Failing to do so may result in permanent data loss.

- Do not open the memory card slot cover and do not remove the memory card.
- Do not disconnect the power source or turn off the camcorder.
- Do not change the position of the  /  switch or the operating mode.

i NOTES



- If the subject is not suitable for autofocus, ● turns yellow. Adjust the focus manually ( 49).
- When the subject is too bright, "OVEREXP." starts flashing. In such case, use the optional FS-43U II ND filter.

10x Optical Zoom

Move the zoom lever toward W to zoom out (wide-angle). Move it toward T to zoom in (telephoto).

You can also change the zoom speed ( 37). You can select one of three fixed zoom speeds or a variable speed that depends on how you operate the zoom lever: Press gently for a slow zoom; press harder for faster zooms.



i NOTES

- You can also use the **T** and **W** buttons on the wireless controller or the LCD panel. The zoom speed with these buttons will be the same as with the camcorder (when one of the fixed zoom speed levels is selected) or fixed at [ SPEED 3] (when [ VARIABLE] is selected).
- When set to [ VARIABLE], the zoom speed will be faster in the record pause mode.
- Keep at least 1 m (3.3 ft.) away from the subject. At wide-angle, you can focus on a subject as close as 1 cm (0.39 in.).

Zooming

✔ POINTS TO CHECK



CAMERA : In addition to the 10x optical zoom, the 200x digital zoom is also available ( 37).

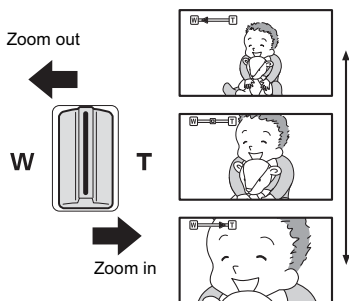

Playback

Playing Back Movies

Play back the tape on the LCD display or close the LCD panel to use the viewfinder.

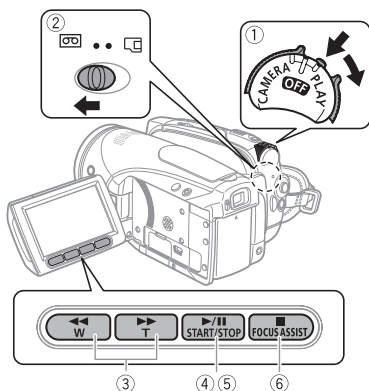

- 1 Holding the lock button pressed down, set the **POWER** switch to **PLAY**.
- 2 Move the / switch to (tape).
- 3 Locate the point where you want to begin the playback.
Press to rewind or to fast forward the tape.
- 4 Press to begin the playback.

DURING PLAYBACK

- 5 Press again to pause the playback.
- 6 Press to stop the playback.

i NOTES

- You can display the date and time of the recording and other camcorder data registered when the recording was made (p. 57).
- During some special playback modes, you may notice some video problems (blocky video artifacts, banding, etc.) in the playback picture.
- During playback, you may notice some video problems at the point where the standard of the recording (HDV/DV) changes.

Special Playback Modes

To enter most special playback modes you need to operate the buttons on the wireless controller (p. 14). There is no sound during the special playback modes.

Special playback mode	Initial mode	On the camcorder press...	On the wireless controller press...
Fast playback	Normal playback	Press and hold or	Press and hold or
Reverse playback	Normal playback	—	
1 frame reverse/advance	Playback pause	—	or
Frame-by-frame playback	Playback pause	—	Press and hold or
Slow playback	Normal or reverse playback	—	
Double speed playback	Normal or reverse playback	—	
Return to normal playback	Special playback mode		

● **During the playback of HDV recordings:** Even though their icons will appear on screen, the following special playback modes are not available.

- Reverse slow playback
- Frame reverse
- Double speed playback (forward or reverse)

● To protect the tape and video heads, the camcorder will enter the stop mode (■) if left in playback pause (▶||) mode for 4 minutes 30 seconds. To resume the playback press ▶||.

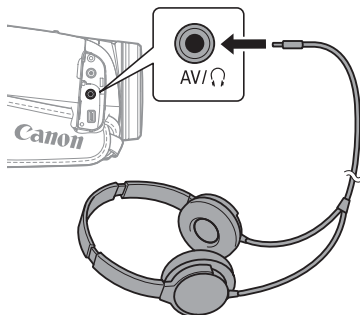

Adjusting the Volume: Speaker and Headphones

The camcorder plays the sound with the built-in speaker. When you're using the viewfinder for playback, you can connect a pair of headphones to listen to the sound. You can also use the headphones to check the audio level while recording.

Adjusting the Volume of the Speaker

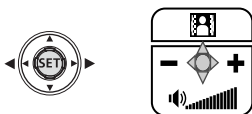

- 1 If the joystick guide does not appear on screen, press (SET) to display it.
- 2 Push the joystick (◀▶) toward + or - to adjust the volume.
 - To turn off the volume completely, keep pressing (◀) until the volume icon changes to OFF.
 - You can press (SET) again to hide the joystick guide during playback.

Using Headphones

The headphones are connected to the AV/PHONES terminal, which is used for both the headphones and the audio/video output. Before connecting the headphones, follow the procedure below to change the function of the terminal from AV output to PHONES (headphones) output and make sure the PHONES icon appears on the screen.



◆ Default value

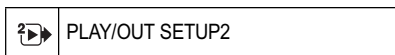

- 1 Press [FUNC.].
- 2 Select (▶) the [] icon and press (SET) to open the setup menus.
- 3 Select (▲▼) [▶▶ PLAY/OUT SETUP2]* and press (SET).
- 4 Select (▲▼) [AV/PHONES] and press (SET).
- 5 Select (▲▼) [PHONES] and press (SET).

6 Press [FUNC.]

appears. Note that if the joystick guide appears on the screen, it will conceal the icon. Press () to hide the joystick guide.

* In **[CAMERA-** mode, select [▶] **PLAY/OUT SETUP]** instead.

TO ADJUST THE VOLUME OF THE HEADPHONES

In **[CAMERA-** mode, adjust the volume of the headphones with the **[PHONES VOL.]** setting (41). In **[PLAY-** mode, use the joystick and the joystick guide following the same procedure as when adjusting the speaker's volume.

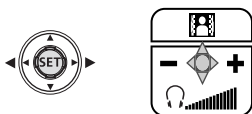

! IMPORTANT

- Do not connect the headphones to the AV/ terminal if the icon does not appear on the screen. If you connect the headphones while the terminal is set to AV output only noise will be output.
- When using headphones, make sure to lower the volume to an appropriate level.
- The sound of the built-in speaker will be muted when you close the LCD panel, when you connect the stereo video cable to the AV/ terminal or when the AV/ terminal is set to [PHONES].

i NOTES

- Use commercially available headphones with a \varnothing 3.5 mm minijack.
- When you turn off the camcorder, the **[AV/PHONES]** setting in **[PLAY-** mode will return to [**AV** AV].
- The volume of the headphones cannot be adjusted while recording.

Returning to a Pre-marked Position

If you wish to return to a particular scene later, mark the point with the zero set memory and the tape will stop at that point when you rewind/fast forward the tape.



1 While recording or during playback, press [ZERO SET MEMORY] on the wireless controller at the point you wish to return to later.

- The time code changes to "0:00:00 .

- Press **[ZERO SET MEMORY]** again to cancel the memory.

2 If you marked the zero memory while recording, set the camcorder to [PLAY- mode. If you marked the zero memory during playback, press .

3 Press [] to locate the zero mark.

- If the tape counter shows a negative number, press instead.
- appears and the camcorder rewinds/fast forwards the tape.
- The tape stops at or near the zero mark, disappears and the correct time code will be displayed again.

i NOTES

If there are blank sections between recordings or sections recorded in different standards (HDV/DV) on the same tape, the zero set memory may not work correctly.

Locating the End of the Last Scene

After playing back a tape, use this function to locate the end of the last scene recorded in order to continue recording from that point.

POINTS TO CHECK



Stop the playback before using this function.

FUNC.
( 23)



- 1 Press **FUNC.**.
- 2 Select (**▲▼**) [**→**] **END SEARCH**] and press (**SET**).
- 3 Select (**◀▶**) [**EXECUTE**] and press (**SET**).
 - "END SEARCH" appears.
 - The camcorder rewinds/fast forwards the tape, plays back the last few seconds of the recording and stops the tape.
 - To cancel the search press .

NOTES

- End search cannot be used once you remove the cassette.
- If there are blank sections between recordings or sections recorded in different standards (HDV/DV) on the same tape, the end search may not work correctly.

Locating Scenes by Recording Date

You can locate the change of the date/ time zone with the date search function.



Press  or  on the wireless controller.

- Press more than once to search for further date changes (up to 10 times).
- To cancel the search press .

NOTES

- Recordings shorter than 1 minute per date/ time zone cannot be located with this function.
- Date search may not function if the date, time or data code are not correctly displayed.
- If there are sections recorded in different standards (HDV/DV) on the same tape, the date search may not work correctly.

Viewing Still Images

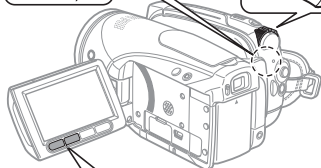

1 Holding the lock button pressed down, set the **POWER** switch to **PLAY**.

2 Move the / switch to (memory card).

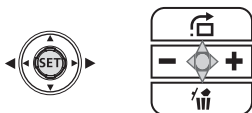

3 Select () the still image.

You can use the joystick to move through the still images even if the joystick guide above does not appear on the screen.

! IMPORTANT

● Avoid the following actions while the card access display appears on screen, and when the **CARD** access indicator is on or flashing. Failing to do so may result in permanent data loss.

- Do not open the memory card slot cover and do not remove the memory card.
- Do not disconnect the power source or turn off the camcorder.
- Do not change the position of the / switch or the operating mode.
- The following may not be displayed correctly.
 - Images not recorded with this camcorder.
 - Images edited on or uploaded from a computer.
 - Images whose file names have been changed.

Image Jump

You can jump ahead to a specific image without having to browse all images one by one.

TO RUN THROUGH THE STILL IMAGES

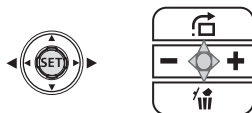

Push the joystick (or) and hold it pressed down.



Release the joystick when the running number gets to the number of the image you want to display.

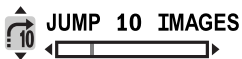

To SKIP 10 OR 100 STILL IMAGES

- 1 If the joystick guide does not appear on screen, press (SET) to display it.
- 2 Push the joystick (▲) toward .



- 3 Select (▲▼) [ JUMP 10 IMAGES] or [ JUMP 100 IMAGES].
- 4 Jump (◀▶) the number of images selected.

Press (SET) to close the image jump screen and display the image. You can press (SET) again to hide the joystick guide.

Slideshow

FUNC.
( 23)



- 1 Press **FUNC.**
- 2 Select (▲▼) [ SLIDESHOW] and press (SET).
- 3 Select (◀▶) [START] and press (SET).
Press **FUNC.** to stop the slideshow.

Index Screen

- 1 Move the zoom lever toward **W**.
The index screen appears.
- 2 Select (▲▼, ◀▶) an image.
 - Move the green selection frame to the image you want to view.
 - If you have a lot of still images, you may find it easier to browse entire index pages instead. Move the zoom lever toward **W** to extend the green selection frame to the whole page, and move (◀▶) through index pages. Move the zoom lever toward **T** to

return to moving between single images.

- 3 Move the zoom lever toward **T**.
The index screen closes and the selected image is displayed.

Magnifying the Playback Image

During playback, movies and still images can be magnified up to 5 times. You can also select the area to be magnified.

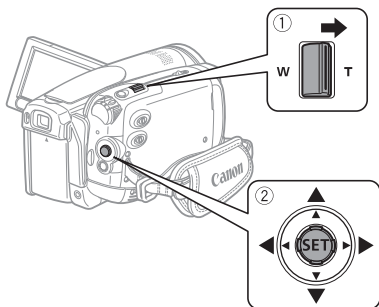

- 1 Move the zoom lever toward **T**.
 - The image is magnified by 2 times and a frame appears indicating the position of the magnified area.
 - To further enlarge the image, move the zoom lever toward **T**. To reduce the magnification, move the zoom lever toward **W**.
 -  will appear for images that cannot be enlarged.
- 2 Select (▲▼, ◀▶) the enlarged area of the picture with the joystick.
To cancel the magnification, move the zoom lever toward **W** until the frame disappears.

Menu Options Lists

Menu items not available appear grayed out. For details about how to select an item, refer to *Using the Menus* (p. 23).

FUNC. Menu Options

Recording programs (p. 45)



Mode switch: P

- [] PROGRAM AE],
- [] SHUTTER-PRIO. AE],
- [] APERTURE-PRIO. AE],
- [] CINE MODE]*

Special scene recording programs:

- [] PORTRAIT], [] SPORTS],
- [] NIGHT], [] SNOW], [] BEACH],
- [] SUNSET], [] SPOTLIGHT],
- [] FIREWORKS]

* only.

Light metering mode (p. 54)



Mode switch: P

- [] EVALUATIVE],
- [] CENT.WEIGHT.AVERAGE],
- [] SPOT]

White balance (p. 50)



Mode switch: P

- [] AUTO], [] DAYLIGHT],
- [] SHADE], [] CLOUDY],
- [] TUNGSTEN], [] FLUORESCENT],
- [] FLUORESCENT H], [] SET]

Image effect (p. 51)



Mode switch: P

- [] IMAGE EFFECT OFF],
- [] VIVID], [] NEUTRAL],
- [] LOW SHARPENING],
- [] SOFT SKIN DETAIL],
- [] CUSTOM]

Drive mode (p. 56)



Mode switch: P

- [] SINGLE], [] CONT.SHOOT.],
- [] HISPEED CONT.SHOOT.],
- [] AEB]

Digital effects (p. 62)



Mode switch: P

- [] D.EFFECT OFF], [] FADE-T],
- [] WIPE], [] BLK&WHT],
- [] SEPIA], [] ART]



Mode switch: P

- [] D.EFFECT OFF], [] BLK&WHT],
- [] SEPIA]

Still image simultaneous recording (p. 53)



Size:

When [HD STANDARD] is set to one of the widescreen (16:9) modes, [] HDV], [] HDV(H) HDV(PF24)] or [] DV(WIDE)]:

- [] STILL I.REC OFF],
- [] 1920x1080], [] 848x480]

When [HD STANDARD] is set to [DV] DV(NORMAL):

[CAMERA] STILL I.REC OFF,
[M] 1440x1080, [S] 640x480

Quality:

[SUPER FINE], [FINE],
[NORMAL]

Still image size/quality (52)



Size:

[LW] 1920x1080, [L] 2048x1536,
[M] 1440x1080, [S] 640x480

Quality:

[SUPER FINE], [FINE],
[NORMAL]

REC PAUSE (71, 72)



[CANCEL], [EXECUTE]

END SEARCH (32)



[CANCEL], [EXECUTE]

Still image capturing (54)



Recordings made in HDV ([HDV] HDV) or [HHDV] HDV(PF24)):

[LW] S.FINE/1920x1080,
[FINE]/1920x1080,
[LW] NORMAL/1920x1080

Recordings made in [DV] DV(WIDE):

[SW] S.FINE/848x480,
[FINE]/848x480,
[SW] NORMAL/848x480

Recordings made in [DV] DV(NORMAL):

[S] S.FINE/640x480,
[FINE]/640x480,
[S] NORMAL/640x480

SLIDESHOW (34)



[CANCEL], [START]

PROTECT (64)



Press (SET) to enter the image selection screen. From that screen, you can continue to select the still images you want to protect.

PRINT ORDER (82)



Press (SET) to enter the image selection screen. From that screen, you can continue to select the still images for which you want to set print orders.

TRANSFER ORDER (78)



Press (SET) to enter the image selection screen. From that screen, you can continue to select the still images you want to mark with a transfer order.

Setup Menus

CAMERA SETUP

ASL SHUTTER



Mode switch: **AUTO** or **P** (only in the [PROGRAM AE] recording program)
 [ON ON], [OFF OFF]

The camcorder automatically uses slow shutter speeds to obtain brighter recordings in places with insufficient lighting.

- The camcorder uses shutter speeds down to 1/30 (1/15 in **CAMERA-L** mode, 1/12 in **CAMERA-C** with cinema effect [HDV HDV (PF24)]).
- **CAMERA-L**: Set the flash mode to ☉ (flash off).
- If a trailing afterimage appears, set the slow shutter to [OFF OFF].
- If 🌀 (camcorder shake warning) appears, we recommend stabilizing the camcorder, for example, by mounting it on a tripod.

D.ZOOM



[OFF OFF], [40x 40X], [200x 200X]
 Determines the operation of the digital zoom.

- When activated, the camcorder will switch automatically to the digital zoom when you zoom in beyond the optical zoom range.
- With the digital zoom the image is digitally processed, so the image resolution will deteriorate the more you zoom in.

- The digital zoom indicator will appear in light blue from 10x up to 40x and dark blue from 40x up to 200x.
- The digital zoom cannot be used with the [NIGHT] recording program.
- A still image cannot be recorded simultaneously on the memory card while recording movies using the digital zoom.

ZOOM SPEED



[VAR VARIABLE], [SPEED 3], [SPEED 2], [SPEED 1]

- When set to [VAR VARIABLE] the zoom speed depends on how you operate the zoom lever: Press lightly for a slow zoom; press harder for faster zooms.
- The fastest zoom speed can be achieved with [VAR VARIABLE]. Among the fixed zoom speeds, [SPEED 3] is the fastest and [SPEED 1] the slowest.

AF MODE



[LAF INSTANT AF], [AF NORMAL AF]
 Select how fast the autofocus will operate.

- With [LAF INSTANT AF] the autofocus adjusts quickly to a new subject. This is convenient for example when changing the focus from a near subject to a far subject in the background, or when recording fast moving subjects.
- When the optional Wide-converter or Tele-converter is attached to the camcorder, it may partially obstruct the Instant AF sensor. Set the AF mode to [AF NORMAL AF].

AF AST LAMP

(□ 59)

[**A** AUTO], [OFF OFF]**FOCUS PRI.**

(□ 55)



Mode switch: P

[**ON** ON: AiAF], [**ON** ON: CENTER],
[**OFF** OFF]**IMG STAB**

Mode switch: P

[**ON** ON], [**OFF** OFF]

The image stabilizer compensates for camcorder shake even at full telephoto.

- The image stabilizer is designed to compensate for a normal degree of camcorder shake.
- The image stabilizer may not be effective when recording in dark places using the [**NIGHT**] recording program.
- The image stabilizer cannot be turned off when the mode switch is set to **AUTO**.
- We recommend setting the image stabilizer to [**OFF** OFF] when using a tripod.

SELF TIMER

(□ 60)

[**ON** ON], [**OFF** OFF]**REC/IN SETUP****HD STANDARD**[**HDV** HDV], [**HDVH** HDV(PF24)],
[**DV** DV(WIDE)], [**DV** DV(NORMAL)]

Selects the video standard of the recording and in DV standard also the aspect ratio.

[**HDV** HDV]: High-definition video at 1080i specifications with 16:9 aspect ratio.

[**HDVH** HDV(PF24)]: High-definition video at 1080i specifications for recording with a progressive frame rate of 24 fps.

When combined with the [**CINE** MODE] recording program (□ 45) to get the 24p Cinema Mode, the cinematic look will be enhanced.

[**DV** DV(WIDE)]: Standard-definition video with 16:9 aspect ratio.

[**DV** DV(NORMAL)]: Standard-definition video with 4:3 aspect ratio.

- We recommend not mixing recordings made in different video standards on the same tape.

● During the playback of a recording made in [**HDVH** HDV(PF24)], **HDV** will appear on the screen (not **HDVH**).

● **Playing back a widescreen recording:** TV sets compatible with the Video ID-1 system will automatically switch to wide (16:9) mode. Otherwise, change the aspect ratio of the TV manually. To play back on a TV with normal aspect ratio (4:3) change the [**TV TYPE**] setting accordingly (□ 40).

DV REC MODE 

[**SP** **STD PLAY**], [**LP** **LONG PLAY**]

When [HD STANDARD] is set to one of the DV standards, you can change the video quality and as a result, also the recording time available on the tape.

- Recording in LP mode extends the available recording time on the tape 1.5 times.
- Depending on the condition of the tape (long usage, imperfections, etc.) you may notice some video problems (blocky video artifacts, banding, etc.) in the playback picture when playing back recordings made in LP mode. We recommend using the SP mode for important recordings.
- If you make recordings in both SP and LP modes on the same tape, during playback you may notice some video problems in the picture at the point where the recording mode changes.
- When playing back in this camcorder tapes recorded in LP mode with other devices or vice versa, you may notice some problems in the playback picture or the sound may stop briefly.

DV AUDIO 

[**16bit** 16bit], [**12bit** 12bit]

When [HD STANDARD] is set to one of the DV standards, you can change the audio quality.

[**16bit** 16bit]: To record sound at the highest quality.

[**12bit** 12bit]: If you will dub audio or add a music track later with an external device.

WIND SCREEN

Mode switch: P

[**A** **AUTO**], [**OFF** **OFF** ]

The camcorder automatically reduces the background sound of wind when recording outdoors.

- The wind screen cannot be turned off when the mode switch is set to **AUTO**.

MIC ATT





 60



[**ON** **ON**], [**OFF** **OFF**]

REVIEW

[**OFF** **OFF**], [**2sec** 2sec], [**4sec** 4sec], [**6sec** 6sec], [**8sec** 8sec], [**10sec** 10sec]
Selects the time to display a still image after it has been recorded.

- You can erase ( 64) the still image while you are reviewing it (or immediately after recording it, if set to [**OFF** **OFF**]).
- This menu item will not be available when the drive mode ( 56) is set to  (continuous shooting),  (high-speed continuous shooting) or  (auto exposure bracketing).
- If you press [**DISP.**] while reviewing a still image, it will continue to be displayed indefinitely. Press [**PHOTO**] halfway to return to the normal display.

AV → DV

 73



[**ON** **ON**], [**OFF** **OFF**]

FILE NOS.

[RESET], [CONTINUOUS]

Select the image numbering method to be used when you insert a new memory card.

Images are automatically assigned consecutive image numbers from 0101 to 9900, and stored in folders containing up to 100 images. Folders are numbered from 101 to 998.

[RESET]: Image numbers will restart from 101-0101 every time you insert a new memory card.

[CONTINUOUS]: Image numbers will continue from the number following that of the last image recorded with the camcorder.

- If the memory card you insert already contains an image with a larger number, a new image will be assigned a number one higher than that of the last image on the memory card.

- We recommend using the [CONTINUOUS] setting.

CARD OPERATIONS

PRINT ORD.ALL ERASE

(83)



[NO], [YES]

TRANS.ORD.ALL ERASE

(79)



[NO], [YES]

ERASE ALL IMAGES

(64)



[NO], [YES]

INITIALIZE

(65)



[CANCEL], [INITIALIZE], [COMPL.INIT.]

PLAY/OUT SETUP*

* In [**PLAY**] mode, the following menu options are divided into two menus, [**PLAY/OUT SETUP1**] and [**PLAY/OUT SETUP2**]; this will be indicated with the respective menu icon.

PLAYBACK STD

[**A** AUTO], [HDV], [DV DV]

Select the video standard to be used for playback.

[**A** AUTO]: Switches automatically between standards (HDV/DV) during playback.

[HDV], [DV DV]: Plays back only the recordings made in the selected standard.

TV TYPE

[**NORMAL TV**], [**WIDE TV**]

In order to display the picture in full and in the correct aspect ratio, select the setting according to the type of television to which you will connect the camcorder.

[**NORMAL TV**]: TV sets with 4:3 aspect ratio.

[**WIDE TV**]: TV sets with 16:9 aspect ratio.



- This setting will be unavailable while the camcorder is connected to an external device using the HDMI cable.

OUTPUT CH



[  L/R], [ L/L], [ R/R]

You can select the audio channel to use during the playback of a tape with audio recorded on two channels.

[  L/R]: Left and Right channels (stereo) / Main + Sub tracks (bilingual).

[ L/L]: Left channel only (stereo) / Main track only (bilingual).

[ R/R]: Right channel only (stereo) / Sub track only (bilingual).

AUDIO OUT



[ST-1 STEREO1], [ST-2 STEREO2], [1:1 MIX/FIXED], [ MIX/VAR.]

You can select the audio track to use during the playback of a tape with audio dubbed over the recording.

[ST-1 STEREO1]: Original sound only.

[ST-2 STEREO2]: Dubbed audio only.



[1:1 MIX/FIXED]: Mixed audio with the original sound and dubbed audio at the same level.

[ MIX/VAR.]: Mixed audio where the balance between the original sound (ST-1) and the dubbed audio (ST-2) can be adjusted.

MIX BALANCE





ST-1  ST-2

When [AUDIO OUT] is set to [ MIX/VAR.], adjust () the sound balance with the joystick.

- The camcorder will retain the audio balance adjustment; however if you turn off the camcorder, [AUDIO OUT] will be reset to [ST-1 STEREO1].



AV/PHONES (30)





[ AV] AV], [ PHONES]

PHONES VOL.



When [AV/PHONES] is set to [ PHONES], adjust () the volume of the headphones with the joystick.

* In [ PLAY] mode, adjust the volume using the joystick guide ( 31).

COMP.OUT



[ 480i] 480i], [ 1080i/480i]

You can select the video specifications to use when connecting the camcorder to a high-definition TV using the video component connection.

[ 480i] 480i]: To use the 480i specification (standard definition).

[ 1080i/480i]: To use the full 1080i high definition specification when possible, or switch automatically to 480i specification when 1080i is not supported by the TV.

- Select the [PLAYBACK STD] and [COMP.OUT] settings according to the specifications you want to use for playback on a high-definition TV. Refer to the table below.

- When the playback standard selected is different from that of the original recording, no video will be output.

- This setting will be unavailable while the camcorder is connected to an external device using the HDMI cable.

DV OUTPUT 

CAMERA  **CAMERA**  | **PLAY**  **PLAY** 

[**DV** DV LOCKED], [**HDTV/DV** HDV/DV]

You can select the video standard to use when connecting to an external device using the HDV/DV terminal.

[**HDTV/DV** HDV/DV]: Switch automatically between standards to match the original standard of the recordings.

[**DV** DV LOCKED]: All video output will be in DV standard (recordings made in HDV will be down-converted).





- Select the [PLAYBACK STD] and [DV OUTPUT] settings according to the specifications you want to use for

playback on a high-definition TV. Refer to the table below.

- The DV output cannot be changed while a DV cable is connected to the HDV/DV terminal.

NOTES

About the [HDMI OUT] display

[HDMI OUT] appears at the bottom of the [ PLAY/OUT SETUP2] menu screen in [**PLAY** ] mode ([ PLAY/OUT SETUP] menu in other modes). This is not a selectable menu option, but rather an information item that displays the specification of the video output when the camcorder is connected to an external device using the HDMI cable. For further details about the HDMI connection, refer to  69.

Settings for Video Output from the COMPONENT OUT Terminal

Video Output Signal	Standard of the Recording on the Tape	[PLAYBACK STD] Setting	[COMP.OUT] Setting
High Definition (1080i)	HDV	[A AUTO] or [HDTV HDV]	[1080i 1080i/480i]
Standard Definition (480i)		[A AUTO] or [HDTV HDV]	[480i 480i]
	DV	[A AUTO] or [DV DV]	[1080i 1080i/480i] or [480i 480i]

Settings for Video Output from the HDV/DV Terminal

Video Output Signal	Standard of the Recording on the Tape	[PLAYBACK STD] Setting	[DV OUTPUT] Setting
High Definition (1080i)	HDV	[A AUTO] or [HDTV HDV]	[HDTV/DV HDV/DV]
Standard Definition (480i)		[A AUTO] or [HDTV HDV]	[DV DV LOCKED]
	DV	[A AUTO] or [DV DV]	[HDTV/DV HDV/DV] or [DV DV LOCKED]

DISPLAY SETUP**BRIGHTNESS**

Adjust (◀▶) the brightness of the LCD display with the joystick.

● Changing the brightness of the LCD display does not affect that of the viewfinder or the recordings.

MARKERS

[OFF OFF], [W LEVEL(WHT)], [G LEVEL(GRY)], [EW GRID(WHT)], [EG GRID(GRY)]

You can display a grid or a horizontal line at the center of the screen. The markers are available in white or gray. Use the markers as a reference to make sure your subject is framed correctly (vertically and/or horizontally).

● Using the markers will not affect the recordings on the tape or memory card.

ASSIST FUNC.

[OFF OFF], [70 ZEBRA(70%)], [100 ZEBRA(100%)], [PEAK PEAKING]

You can use the assist functions to make sure you adjust the focus and exposure correctly.

[ZEBRA]: A striped pattern (zebra pattern) will appear over areas of the picture that are overexposed (too bright). [70 ZEBRA(70%)] is more sensitive than [100 ZEBRA(100%)].

[PEAK PEAKING]: The silhouettes of objects in the picture will be emphasized

in order to allow you to focus manually more easily.

● Using the assist functions will not affect the recordings on the tape or memory card.

AUDIO LEVEL

(61)



[ON ON], [OFF OFF]

TV SCREEN

[ON ON]*, [OFF OFF]

When set to [ON ON], the camcorder's on-screen displays will appear also on the screen of a connected TV or monitor.

● You can also use [DISP.] on the wireless controller.

● When the the data code is displayed on the camcorder's screen, the same information will also appear on a connected TV regardless of the [TV SCREEN] setting. Turn off the data code display by repeatedly pressing [DISP.]

* The default value is [OFF OFF] in the playback modes.

6SEC.DATE

[ON ON], [OFF OFF]

When you start playing back a tape or when the date of the recording changes, the date and time will be displayed for 6 seconds.

DATA CODE

(57)



[DATE], [TIME], [DATE & TIME], [CAMERA DATA]

LANGUAGE

(24)



[DEUTSCH], [ENGLISH], [ESPAÑOL],
 [FRANÇAIS], [ITALIANO], [POLSKI],
 [ROMÂNĂ], [TÜRKÇE], [РУССКИЙ],
 [УКРАЇНСЬКА], [العربية], [فارسی],
 [ភាសាខ្មែរ], [简体中文], [繁體中文], [한국어],
 [日本語]

DEMO MODE

[ON ON], [OFF OFF]

The demonstration mode displays the camcorder's main features. It starts automatically when the camcorder is powered with the power adapter if you leave it turned on without loading a recording media for more than 5 minutes.

- To cancel the demo mode once it started, press any button, turn off the camcorder or load a recording media.

SYSTEM SETUP**WL.REMOTE**

[ON ON], [OFF OFF] (24)

Allows the camcorder to be operated with the wireless controller.

BEEP

[4] HIGH VOLUME],
 [1] LOW VOLUME], [OFF OFF]

A beep will accompany some operations like turning on the camcorder, the self-timer countdown, etc. It also serves as a warning beep under unusual conditions.

POWER SAVE

[ON ON], [OFF OFF]

In order to save power when the camcorder is powered by a battery pack, it will automatically shut off if left without any operation for 5 minutes.

Approximately 30 seconds before the camcorder shuts off, the message "⚠️ AUTO POWER OFF" will appear.

FIRMWARE

You can verify the current version of the camcorder's firmware. This menu option is usually grayed out.

DATE/TIME SETUP**T.ZONE/DST**

(24)

DATE/TIME

(25)

DATE FORMAT

[Y.M.D (2007.1.1 AM 12:00)],
 [M.D,Y (JAN. 1, 2007 12:00 AM)],
 [D.M.Y (1.JAN.2007 12:00 AM)]

Changes the date format for on-screen displays and for date printing.

Using the Recording Programs

AUTO ● ● P



AUTO Auto

The camcorder adjusts the focus, exposure and other settings automatically, allowing you to just point and shoot.



P : Flexible Recording Programs (46)

[P] PROGRAM AE

The camcorder sets the aperture and shutter speed.

[TV] SHUTTER-PRIO. AE

You select the shutter speed.

[AV] APERTURE-PRIO. AE

You select the aperture value.

Special Scene Recording Programs (47)

[P] PORTRAIT

The camcorder uses a large aperture, achieving a focus on the subject while blurring other distracting details.



[S] SNOW

Use this mode to record in bright ski resorts. It prevents the subject from being underexposed.



[C] CINE MODE*

Give a cinematic look to your recordings.

* **[CAMERA]** only.

[S] SPORTS

Use this mode to record sports scenes such as tennis or golf.



[B] BEACH

Use this mode to record on a sunny beach. It prevents the subject from being underexposed.



[A] SPOTLIGHT

Use this mode to record spotlight scenes.



[N] NIGHT

Use this mode to record in low-light conditions.



[S] SUNSET

Use this mode to record sunsets in vibrant colors.



[F] FIREWORKS

Use this mode to record fireworks.



P Flexible Recording: Changing the Aperture and Shutter Speed

Use the automatic exposure (AE) program or give priority to the exposure value or the shutter speed.

POINTS TO CHECK



* **CAMERA-**: Only settings other than **[] CINE MODE**.

Mode switch: P

AUTO ●● P



Options

◆ Default value

[] PROGRAM AE◆

The camcorder automatically adjusts the aperture and shutter speed to obtain the optimal exposure for the subject.

[] SHUTTER-PRIO.AE

Set the shutter speed value. The camcorder automatically sets the appropriate aperture value. Use a high shutter speed to record fast moving subjects or a slow shutter speed to add motion blur, emphasizing the feel of movement.

[] APERTURE-PRIO.AE

Set the aperture value. The camcorder automatically sets the appropriate shutter speed. Use low aperture values (larger lens opening) to softly blur the background in a portrait or high aperture values (smaller lens opening) to get a wider depth of field, giving a sharp focus all throughout a landscape.

[] CINE MODE*

The camcorder adjusts various image settings to give a cinematic look to your recordings. The effect will be enhanced when this recording mode is combined with the **[] HDV (PF24)** setting (**[] 38**) to get the 24p Cinema Mode.

* **CAMERA-** only.

FUNC.
(23)



FUNC. → Icon of the currently selected **Recording Program**



FUNC. ← Desired option

TO SET THE APERTURE VALUE OR SHUTTER SPEED

When you select **[] SHUTTER-PRIO.AE** or **[] APERTURE-PRIO.AE**, a numeric value will appear next to the recording program icon.

- 1 If the joystick guide appears on the screen, press (**SET**) to hide it.
- 2 Adjust (**▲▼**) the shutter speed or aperture to the desired value.

Shutter speed guidelines

CAMERA-	1/8, 1/15, 1/30
CAMERA- with cinema effect	
[] HDV (PF24)	1/6, 1/12, 1/24
CAMERA-	1/2, 1/4, 1/8, 1/15, 1/30

For recording subjects in dark places.

CAMERA-	1/60
CAMERA- with cinema effect	
[] HDV (PF24)	1/48, 1/60
CAMERA-	1/60

For general recordings.

	1/100
	1/100
For recording indoor sports scenes.	
	1/250, 1/500, 1/1000
	1/250, 1/500
For recording from within a car or train, or for recording moving subjects such as roller coasters.	
	1/2000
For recording outdoor sports such as golf or tennis on sunny days.	

Note that on screen only the denominator is displayed – [1/250] indicates a shutter speed of 1/250 second, etc.

Available Aperture Values

- [1.8], [2.0], [2.4], [2.8], [3.4], [4.0], [4.8], [5.6], [6.7], [8.0]
- [2.8], [3.4], [4.0], [4.8], [5.6], [6.7], [8.0]

NOTES

- When the mode switch is set to **AUTO**, the joystick guide will not appear.
- Do not change the position of the mode switch while recording, as the brightness of the image may change abruptly.
- When setting a numeric value (aperture or shutter speed), the number display will flash if the aperture or shutter speed is not appropriate for the recording conditions. In such case, select a different value.
- [1/25] SHUTTER-PRIO.AE]**
 - If you use a slow shutter speed in dark places, you can obtain a brighter image, but the image quality may be lower, and the autofocus may not work well.
 - The image may flicker when recording with high shutter speeds.
 - Recording movies under fluorescent lights:** If the screen starts to flicker, select **[1/25] SHUTTER-PRIO.AE]** and set the shutter speed to 1/100.
- [1/25] APERTURE-PRIO.AE]**
 - The actual range of values available for selection will vary depending on the initial zoom position.

Special Scene: Recording Programs to Match Special Conditions

Recording in a very bright ski resort or capturing the full colors of a sunset or a fireworks display becomes as easy as selecting a Special Scene recording program.

POINTS TO CHECK



Mode switch: P



FUNC.
(23)

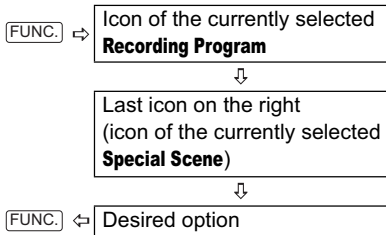

NOTES

- Do not change the position of the mode switch while recording, as the brightness of the image may change abruptly.
- [1/25] PORTRAIT]/[1/25] SPORTS]/[1/25] BEACH]/[1/25] SNOW]**
 - The picture may not appear smooth during playback.
- [1/25] PORTRAIT]**
 - The blur effect of the background increases the more you zoom in (T).

- [NIGHT]

- Moving subjects may leave a trailing afterimage.
- Picture quality may not be as good as in other modes.
- White points may appear on the screen.
- Autofocus may not work as well as in other modes. In such case, adjust the focus manually.

- [SNOW]/[BEACH]

- The subject may become overexposed on cloudy days or in shaded places. Check the image on the screen.

- [FIREWORKS]

- To avoid camcorder shake, we recommend using a tripod. Make sure to use a tripod especially in [CAMERA], as the shutter speed slows down.

Adjusting the Picture: Exposure, Focus and Color

Manual Exposure Adjustment and Automatic Backlight Correction

At times, backlit subjects may appear too dark (underexposed) or subjects under very strong lights may appear too bright or glaring (overexposed). To correct this you can use the automatic backlight correction or manually adjust the exposure.

Automatic Backlight Correction

When shooting subjects with a strong light source behind them, you can have the camcorder automatically correct for the backlight with the press of a single button.

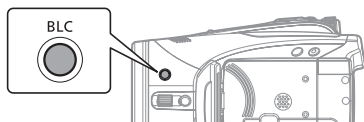

Press [BLC].

- A sun icon appears.
- Press [BLC] again to end the backlight correction mode.

Manual Exposure Adjustment

POINTS TO CHECK



(10)

Mode switch: P (except for the [FIREWORKS] recording program).



1 If the joystick guide does not appear on screen, press (SET) to display it.

2 Push the joystick (▲) toward [EXP].

- If [EXP] does not appear on the joystick guide, repeatedly push the joystick (▼) toward [NEXT] to display the joystick guide in the illustration above.
- The exposure adjustment indicator  and the neutral value "±0" appear on the screen.
- If you operate the zoom while the exposure is locked, the brightness of the image may change.

3 Adjust (◀▶) the brightness of the image as required.

- The adjustment range and the length of the exposure adjustment indicator will vary depending on the initial brightness of the picture.
- Pushing the joystick (▲) toward [EXP] again will return the camcorder to automatic exposure.

Fast moving subjects



Through wet windows



Night scenes



POINTS TO CHECK



Adjust the zoom before you start the procedure.

Mode switch: P

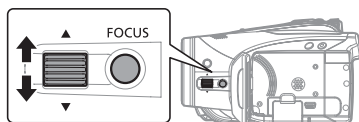

- 1 Press [FOCUS].**
"MF" appears.
- 2 Adjust the focus as necessary with the FOCUS dial until the image appears focused.**
Pressing [FOCUS] again will return the camcorder to autofocus.

NOTES

The camcorder will automatically return to autofocus when you set the mode switch to **AUTO**.

Manual Focus Adjustment

Autofocus may not work well on the following subjects. In such case, focus manually.

Reflective surfaces



Subjects with low contrast or without vertical lines



Infinity Focus

Use this function when you wish to focus on faraway subjects such as mountains or fireworks.

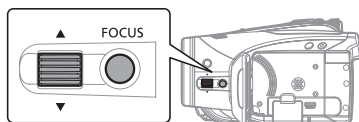

1 Adjust the zoom.**2 In autofocus mode, keep [FOCUS] pressed down for more than 2 seconds.**

- ∞ appears.
- Pressing [FOCUS] again will return the camcorder to autofocus.
- Operating the zoom or the FOCUS dial will return the camcorder to manual focus adjustment (MF).

Focus Assist Functions

The focus assist function will magnify the center of the picture and emphasize the outlines of the objects on screen (peaking) to make it easier for you to focus manually.

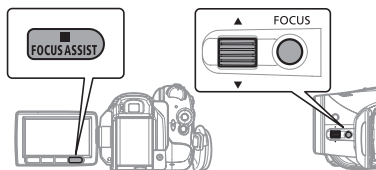
**POINTS TO CHECK**

Mode switch: P

1 Press [FOCUS].

"MF" appears.

2 Press [FOCUS ASSIST].

The center of the picture will be magnified and the silhouettes will be emphasized.

3 Adjust the focus as necessary with the FOCUS dial until the image appears focused.**NOTES**

- Using the focus assist functions will not affect the recordings on the tape or memory card. When you start recording, the assist functions will be canceled.
- You can also apply the peaking function (without the magnification) by setting [ASSIST FUNC.] to [PEAK PEAKING] (p. 43). In that case, the peaking function will not be canceled even when you start recording.
- In [CAMERA] mode, you can also use the focus assist functions after pressing [PHOTO] halfway.
- The camcorder will automatically return to autofocus when you set the mode switch to [AUTO].

White Balance

The white balance function helps you accurately reproduce colors under different lighting conditions so that white objects will always look truly white in your recordings.

POINTS TO CHECK

Mode switch: P (except for the Special Scene recording programs)

Options

♦ Default value

[AMB AUTO]♦

Settings are automatically set by the camcorder. Use this setting for outdoor scenes.

[☀ DAYLIGHT]

For recording outdoors on a bright day.

[☁ SHADE]

For recording in shaded places.

[☁ CLOUDY]

For recording on a cloudy day.

[TUNGSTEN]
For recording under tungsten and tungsten type (3-wavelength) fluorescent lighting.
[FLUORESCENT]
For recording under warm white, cool white or warm white type (3-wavelength) fluorescent lighting.
[FLUORESCENT H]
For recording under daylight or daylight type (3-wavelength) fluorescent lighting.
[SET]
Use the custom white balance for special situations not covered by the other options. The custom white balance will ensure that white subjects appear white under various lighting conditions.

NOTES

- When you select the custom white balance [SET]:
 - Make the white balance adjustment in a place with sufficient light.
 - Set [D.ZOOM] to [OFF] (37).
 - Readjust the white balance if the lighting conditions change.
 - Very rarely and depending on the light source, may keep on flashing instead of staying on. Even in that case, the white balance would be properly adjusted and the results should be better than with [AUTO].
 - Custom white balance may provide better results in the following cases:
 - Changing lighting conditions
 - Close-ups
 - Subjects in a single color (sky, sea or forest)
 - Under mercury lamps and certain types of fluorescent lights
 - Depending on the type of fluorescent light, optimal color balance may not be obtained with [FLUORESCENT] or [FLUORESCENT H]. If the color looks unnatural, adjust it using [AUTO] or [SET].

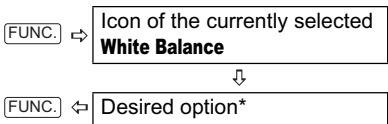

* When you select [SET], do not press [FUNC.] and continue instead with the procedure below.

TO SET THE CUSTOM WHITE BALANCE

- 1 Point the camcorder at a white object, zoom in until it fills the whole screen and press (SET). When the adjustment is completed stops flashing and stays on. The camcorder retains the custom setting even if you turn off the camcorder.
- 2 Press [FUNC.] to save the setting and close the menu.

Image Effects

You can use the image effects to change the color saturation and contrast of your recordings.





POINTS TO CHECK



Mode switch: P (except for the Special Scene recording programs)

Options ♦ Default value

[IMAGE EFFECT OFF]♦
Records with no image enhancing effects.
[VIVID]
Emphasizes the contrast and color saturation.

[ NEUTRAL]
Tones down the contrast and color saturation.
[ LOW SHARPENING]
Records subjects with softened outlines.
[ SOFT SKIN DETAIL]
Softens the details in the skin tone area for a more complimentary appearance.
[ CUSTOM]
Allows you to adjust the brightness, contrast, sharpness, and color depth of the image.
[COL.DEPTH]: (-) Shallower colors, (+) Richer color tonality
[BRIGHTN.]: (-) Darker picture, (+) Brighter picture
[CONTRAST]: (-) Flatter picture, (+) More defined light and shade
[SHARPNESS]: (-) Vaguer outlines, (+) Sharper outlines

FUNC.
( 23)



FUNC. →

Icon of the currently selected
Image Effect







FUNC. ←

Desired option*

* When you select [ CUSTOM], do not press **FUNC.** and continue instead with the procedure below.

TO SET THE CUSTOM IMAGE EFFECT

- 1 Press ().
- 2 Select () each of the custom setting options and adjust () as desired.
- 3 Press () to save the custom image effect.
- 4 Press **FUNC.** to close the menu.

Still Image Recording Options



Selecting the Size and Quality of Still Images

Still images are recorded on the memory card using the JPEG (Joint Photographic Experts Group) compression. As a general rule select a larger image size for higher quality.





Options



Approximate number of still images that can be recorded on different sizes of memory cards with the following quality settings:

 : [SUPER FINE],  : [FINE],
 : [NORMAL].

On a 32 MB memory card

Image Size			
LW 1920x1080	20	30	60
L 2048x1536	10	20	40
M 1440x1080	25	40	80
SW 848x480*	105	155	310
S 640x480	140	205	375

On a 128 MB memory card

Image Size			
LW 1920x1080	90	135	265
L 2048x1536	60	85	180
M 1440x1080	120	180	350
SW 848x480*	455	650	1,300
S 640x480	600	865	1,560

On a 512 MB memory card

Image Size			
LW 1920x1080	350	525	1,040
L 2048x1536	235	350	700
M 1440x1080	470	700	1,370
SW 848x480*	1,775	2,515	5,030
S 640x480	2,320	3,355	6,040

* This size is only available for recording simultaneously on the tape and memory card (53) or for capturing a still image from the playback picture (54).

◆ Default value

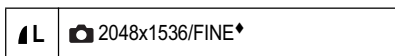

FUNC.
(23)



FUNC. →

Icon of the currently selected
Image Quality/Size



Desired image size*



Press ()



FUNC. ↔

Desired image quality*

* The number displayed on the right corner indicates the approximate number of images that can be recorded with the current quality/size setting.

NOTES

- Depending on the number of images on the memory card (Windows: more than 1,800 images; Macintosh: more than 1,000 images), you may not be able to download images to a computer. Try using a card reader.
- Connection to a PictBridge compatible printer will not work when the memory card contains more than 1,800 images. For best performance, we recommend keeping the number of images on the memory card under 100.

- When printing still images, use the following guidelines as a reference for selecting the print size.

Image Size	Recommended Use
L 2048x1536	To print photos up to A4 size.
M 1440x1080	To print photos up to L size (9 x 13 cm, 3.5 x 5 in.) or postcard size (10 x 14.8 cm, 4 x 6 in.).
S 640x480	To send images as e-mail attachments or to post on the Web. Select this size also to be able to record more still images if memory card capacity is limited.

Capturing a Still Image while Recording Movies

You can record still images on the memory card even while the camcorder is set to **CAMERA** mode. You can also capture simultaneously, as a still image on the memory card, the same picture you are recording as video on the tape. The size and quality of the still image can be selected.

POINTS TO CHECK



Select the size and quality of the still image in record pause mode before you start recording.

◆ Default value

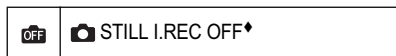

FUNC.
 ( 23)

FUNC. →

 Icon of the currently selected
**Still Image Simultaneous
 Recording** option

Desired image size*

 Press ()

FUNC. ←

Desired image quality*

* The number displayed on the right corner indicates the approximate number of images that can be recorded with the current quality/size setting.

Press () to capture the still image on the memory card.

The still image is recorded on the memory card while the screen continues to show the video recording.

 **NOTES**

- The still image cannot be recorded on the memory card while using the digital zoom or while a digital effect is activated.
- To record still images we recommend using the () mode, which offers the best quality for still images.

Capturing a Still Image from the Playback Picture

While you are playing back a tape you can capture the picture as a still image on the memory card. The quality of the captured still image can be selected but its size cannot be changed (it will depend on the recording standard of the tape being played back).

 ( 10)

FUNC.
 ( 23)

FUNC. →

 Icon of the currently selected
Still Image Capturing option

FUNC. ←

Desired image quality



TO CAPTURE THE STILL IMAGE

1 Pause the playback when the scene you want to capture as a still image appears.

You can also use the frame-by-frame playback to find the exact picture you want to capture.

2 Press ().

 **NOTES**

- The data code of the still image will reflect the date and time of the original recording on the tape.
- The still image cannot be captured on the memory card if [TV TYPE] is set to [ NORMAL TV]. Set it to [ WIDE TV] instead ( 40).
- A still image captured from a scene with lots of fast movement may be blurred.

Light Metering Mode

The camcorder measures the light reflected from the subject in order to calculate the optimal exposure settings. Depending on the subject, you may want to change the way the light is measured and evaluated.



POINTS TO CHECK



Mode switch: P (except for the Special Scene recording programs)

Options

♦ Default value

[ EVALUATIVE]♦
Appropriate for standard shooting conditions, including backlit scenes. The camcorder divides the picture into several areas and the light is measured in all of them to achieve the optimal exposure for the subject.
[ CENT.WEIGHT.AVERAGE]
Averages the light metered from the entire screen, giving more weight to the subject in the center.
[ SPOT]
Meters only the area within the spot AE point frame. Use this setting to adjust the exposure to match the subject in the center of the screen.

FUNC.
( 23)

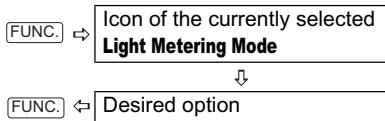

Automatic Focus Priority

When the focus priority is activated, the camcorder records a still image only after the focus has been adjusted automatically.

POINTS TO CHECK





Mode switch at **AUTO**: The focus priority cannot be turned off.

Mode switch at **P**: You can turn off the focus priority and you can also select the AF (autofocus) mode to be used.

Options

♦ Default value

[ ON: AiAF]♦ (Mode switch: P *, AUTO)
Depending on the shooting conditions, one or more AF frames out of the nine frames available are automatically selected and the focus is fixed on them.
[ ON: CENTER] (Mode switch: P *)
In this mode, a single focusing frame appears in the center of the screen and the focus is automatically fixed on it. This is convenient for making sure the focus is exactly where you want it.
[ OFF OFF]
Select this option if you wish to record a still image as soon as you press PHOTO .

* Except for the **[ FIREWORKS]** recording program.

FUNC.
( 23)

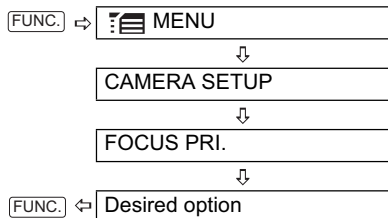

i NOTES

In the [🔥 FIREWORKS] recording program the focus priority is automatically set to [OFF OFF].

Continuous Shooting and Exposure Bracketing

Take a series of pictures of a moving subject or record the same picture in 3 levels of exposure in order to choose later the picture you like the best.

✓ POINTS TO CHECK

Mode switch: P (except for the [🔥 FIREWORKS] recording program).

Options

◆ Default value

[<input type="checkbox"/> SINGLE]◆
Records a single still image.
[CONT.SHOOT.] (Continuous Shooting), [HISPEED CONT.SHOOT.] (High-Speed Continuous Shooting)
Captures a series of still images as long as you hold [PHOTO] pressed down. For the number of frames per second, refer to the table below.
[AEB] (Auto Exposure Bracketing)
The camcorder records a still image in three different exposures (dark, normal, light in 1/2 EV steps), allowing you to choose the shot you like the best.

FUNC.
(📖 23)

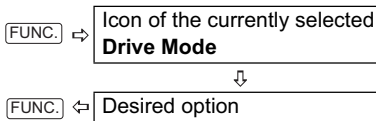

CONTINUOUS SHOOTING/ HIGH-SPEED CONTINUOUS SHOOTING

- 1 Press [PHOTO] halfway to activate the autofocus.
- 2 Press [PHOTO] fully and hold it pressed down.

A series of still images will be recorded as long as you hold the button pressed down.

AUTO EXPOSURE BRACKETING

Press [PHOTO], first halfway to activate the autofocus and then fully to record the still image.

Three still images in different exposures will be recorded on the memory card.

i NOTES

- The speed and maximum number of continuous shots is as follows.
 - [CONT.SHOOT.]: Approx. 3 images/second
 - [HISPEED CONT.SHOOT.]: Approx. 5 images/second
 - Continuous Shooting with flash: Approx. 2.1 images/second
 - Maximum number of shots: 60 still images
- These figures are approximate and vary with the recording conditions and subjects.
- The actual number of images per second will be lower when "🌀" (camcorder shake warning) is displayed on the screen.

Other Functions

On-Screen Displays

The camcorder keeps a data code containing the date and time and other camera data (shutter speed, aperture, etc.) registered at the time of recording. You can select the data to be displayed.

Turning the On-Screen Displays On/Off

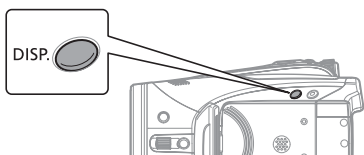

Repeatedly press **DISP.** to turn the on-screen displays on/off in the following sequence.



All displays on → Only tape-related displays¹



On-screen displays + Data code² on →

Only on-screen displays on →

Only tape-related displays (in stop mode or playback pause) or All displays off (during playback)



On-screen displays + Histogram³/Data code on → Only on-screen displays on → All displays off

¹ Tape related displays: Tape operation icon, time code and remaining tape display.

² Data code: Time, date and camera data at the time of recording. The contents to be displayed can be selected as explained in the following section.

³ Histogram display: For still images you can display the complete camera data registered at the time of recording. For details on how to read the histogram display, refer to the following section.

Selecting the Data Code

You can select the data code to be displayed when playing back movies.



Options

◆ Default value

[DATE], [TIME]
Displays the date or time when the scene or still image was recorded.
[DATE & TIME]◆
Displays both the date and time of the recording.
[CAMERA DATA]
Displays the aperture (f-stop) and shutter speed used when recording the image.

FUNC.
(23)

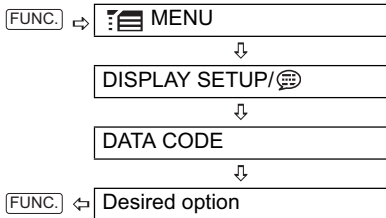
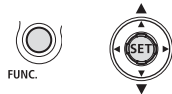

Reading the Histogram Display

When viewing still images you can display the histogram and the icons of all the functions used at the time of recording. Use the histogram as a reference to verify the correct exposure of the still image.

The area to the right of the histogram represents highlights and the left side represents shadows. A still image whose histogram skews to the right is relatively bright; while one whose histogram peaks to the left, is relatively dark.

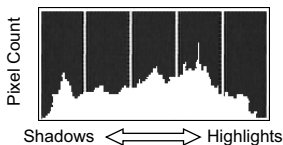

i NOTES

The histogram display will appear also after recording a still image while reviewing it within the time set for the [REVIEW] option (or immediately after recording it, if [REVIEW] is set to [OFF OFF]).

Flash

You can use the built-in flash for recording still images in dark places. The flash features the red-eye reduction function.

✓ POINTS TO CHECK



Select a recording program other than [FIREWORKS].

Options

◆ Default value

⚡^A (auto)◆
The flash fires automatically according to the brightness of the subject.
⊙ (red-eye reduction, auto)
The assist lamp lights up to reduce the red-eye effect. The flash fires automatically according to the brightness of the subject.
⚡ (flash on)
The flash always fires.
⊕ (flash off)
The flash does not fire.

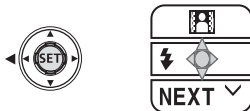



- 1 If the joystick guide does not appear on screen, press (SET) to display it.**
- 2 Push the joystick (◀) toward ⚡.**
If ⚡ does not appear on the joystick guide, repeatedly push the joystick (▼) toward [NEXT] to display the joystick guide in the illustration above.
 - Repeatedly push the joystick (◀) toward ⚡ to cycle between the flash modes.
 - The display ⚡^A disappears after 4 seconds.

3 Press **PHOTO**, first halfway to activate the autofocus and then fully to record the still image.

TO USE THE OPTIONAL VFL-1 VIDEO FLASH LIGHT

You can attach the optional VFL-1 Video Flash Light to the advanced accessory shoe if you want a more powerful flash than the built-in flash. The procedure for setting the flash mode is the same as described above. For details about attaching and using the flash, refer to the instruction manual of the VFL-1. The VFL-1 can also be used as a video light. When a video accessory is attached to the advanced accessory shoe,  will appear on the screen.

i NOTES

- The practical range of the built-in flash is approx. 1 to 2 m (3.3 to 6.6 ft.). The practical range with the VFL-1 Video Flash Light attached is approx. 1 to 4 m (3.3 to 13.1 ft.). In any case, the actual range will depend on the recording conditions.
- The range of the flash decreases in continuous shooting mode.
- For the red-eye reduction function to be effective, the subject needs to look at the assist lamp. The degree of reduction depends on the distance and on each individual.
- The flash will not fire in the following cases:
 - When you manually adjust the exposure in  (auto) or  (red-eye reduction) mode.
 - During auto exposure bracketing.
- The flash mode cannot be selected when the exposure is locked.
- We do not recommend using the flash when the optional Wide-converter or Tele-converter is attached; its shadow can appear on the screen.
- **About the AF-Assist Lamp:** While you press **PHOTO** halfway, if the subject is too dark the assist lamp may light up briefly in order to enable the camcorder to focus more accurately (AF-assist lamp). You can also set [AF AST LAMP] to [**OFF** OFF] so the assist lamp does not light up.
 - The camcorder may not be able to focus even if the AF-assist lamp is on.

- The brightness of the AF-assist lamp could be an inconvenience. Consider turning it off in public places such as restaurants or theaters.

Mini Video Light

You can turn on the mini video light (assist lamp) at any time regardless of the recording program.

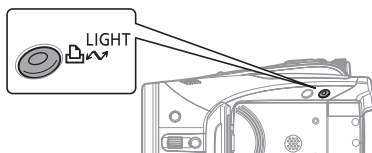

Press **LIGHT**.

-  appears on the screen.
- Press **LIGHT** again to turn the mini video light off.

TO USE THE OPTIONAL VL-3 VIDEO LIGHT

You can attach the optional VL-3 Video Light to the advanced accessory shoe if you want a more powerful video light than the built-in mini video light. For details about attaching and using the video light, refer to the instruction manual of the VL-3. When a video accessory is attached to the advanced accessory shoe,  will appear on the screen.

i NOTES

- We do not recommend using the mini video light while the optional Wide-converter is attached; its shadow can appear on the screen.
- The built-in mini video light will be disabled automatically when you attach the optional VL-3 Video Light. To use the built-in mini video light, set the switch on the VL-3 to OFF and then press **LIGHT**.

Self Timer

POINTS TO CHECK



(10)

CAMERA : Set the camcorder in record pause mode.

FUNC.

(23)

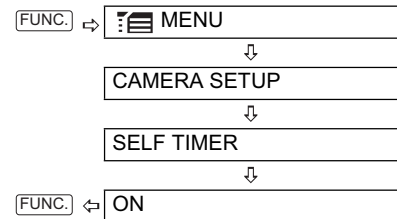

appears.

CAMERA :

Press **START/STOP**.

The camcorder starts recording after a 10-second countdown*. The countdown appears on the screen.

CAMERA :

Press **PHOTO**, first halfway to activate the autofocus and then fully to record the still image.

The camcorder will record the still image after a 10-second countdown*. The countdown appears on the screen.

*2 seconds when using the wireless controller.

NOTES

Once the countdown has begun, you can cancel the self timer by turning off the camcorder.

Audio Recording Level

You can adjust the audio recording level for the built-in or for an external microphone. You can display the audio level indicator while recording or playing back the tape.

Manual Adjustment of the Audio Recording Level

POINTS TO CHECK



(10)

Mode switch: P

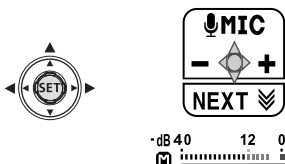

1 If the joystick guide does not appear on screen, press **(SET)** to display it.

2 Push the joystick (**▲**) toward **[MIC]**.

- If **[MIC]** does not appear on the joystick guide, repeatedly push the joystick (**▼**) toward **[NEXT]** to display the joystick guide in the illustration above.
- The manual adjustment icon will appear to the left of the audio level indicator and the manual adjustment bar (green) will appear below it.

Manual audio level adjustment

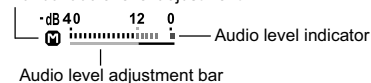

3 Adjust (◀▶) the audio level as necessary.

- Push the joystick (▶) toward + to raise the audio recording level or push it (◀) toward - to lower it.
- As a guideline, adjust the audio recording level so that the audio level meter will go to the right of the -12 dB mark only occasionally.
- When the 0 dB mark turns red, the sound may be distorted.

4 Press (SET) to save the setting and hide the joystick guide.

TO USE THE MICROPHONE ATTENUATOR

If the audio level is too high and the sound gets distorted, activate the microphone attenuator by setting [MIC ATT.] to [ON ON] (☞ 39).

i NOTES

- The audio recording level can be adjusted only while the green adjustment bar appears under the audio level indicator. To avoid changing the level by mistake, after you manually adjust the audio recording level be sure to press (SET) to hide the joystick guide.
- When the mode switch is set to **AUTO**, the camcorder will adjust the audio level automatically.
- We recommend using headphones (☞ 30) to check the sound level while adjusting the audio recording level or when the microphone attenuator is activated.

Displaying the Audio Level Indicator

Usually, the audio level indicator will be displayed only after the manual adjustment of the audio recording level. With the procedure below, you can display the audio level indicator also when the audio level is adjusted automatically or during playback.

✓ POINTS TO CHECK



(☞ 10)

FUNC.
(☞ 23)

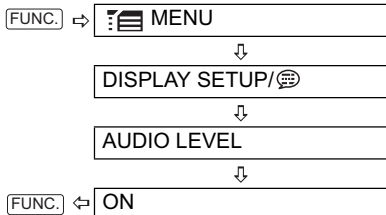
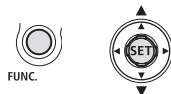

Using an External Microphone

When recording in very quiet surroundings, the built-in microphone may pick up the sound of the camcorder's internal machinery. In such case, we recommend using an external microphone.

MICROPHONES COMPATIBLE WITH THE ADVANCED ACCESSORY SHOE ..S

You can attach to the advanced accessory shoe on the camcorder an optional DM-50 Directional and Stereo Microphone or any commercially available microphone compatible with the advanced accessory shoe. For details, refer to the instruction manual of the microphone.

When a video accessory is attached to the advanced accessory shoe, ..S will appear on the screen.

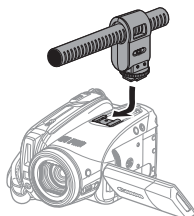

OTHER MICROPHONES

You can also use commercially available microphones not compatible with the advanced accessory shoe, by connecting the external microphone to the MIC terminal. Use commercially available condenser microphones with their own power supply. You can connect almost any stereo microphone with a \varnothing 3.5 mm plug but the audio recording level may vary.

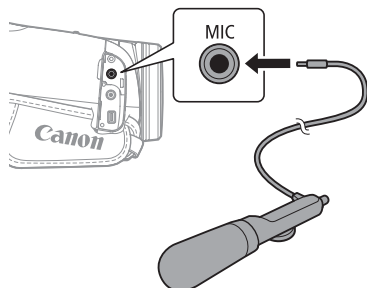

i NOTES

Be careful when attaching a very long external microphone; it may appear on the screen.

Digital Effects

✓ POINTS TO CHECK



* **CAMERA** : [**31**] BLK&WHT], [**32**] SEPIA] only.

Mode switch: P

Options

◆ Default value

[**OFF**] D.EFFECT OFF]◆

Select this setting when you do not intend to use the digital effects.

[**31**] FADE-T] (fade trigger), [**32**] WIPE]

Select one of the faders to begin or end a scene with a fade from or to a black screen.

[**31**] BLK&WHT]

Records images in black and white.

[**32**] SEPIA]

Records images in sepia tones for an "old" look.

[**33**] ART]

Select this effect to add flavor to your recordings.

i NOTES

- You can preview the digital effects on the screen while making the selection.
- When you apply a fader, not only the picture but also the sound will fade in or out. When you apply an effect, the sound will be recorded normally.
- The camcorder retains the setting last used even if you turn off the digital effects or change the recording program.

Setting

FUNC.
(23)



FUNC. →

Icon of the currently selected
Digital Effect



FUNC.** ⇐

Desired digital effect.*

* You can preview the effect on the screen before pressing **FUNC.**.

**The icon of the selected effect appears.

Applying

Depending on the operation mode, these positions may be empty or show a different icon.

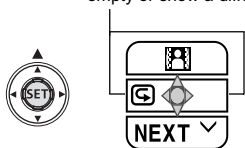

1 If the joystick guide does not appear on screen, press (**SET**) to display it.

2 Push the joystick (**▲**) toward **[D.EFFECTS]**.

If **[D.EFFECTS]** does not appear on the joystick guide, repeatedly push the joystick (**▼**) toward **[NEXT]** to display the joystick guide in the illustration above.

- The icon of the selected effect turns green.
- Push the joystick (**▲**) toward **[D.EFFECTS]** again to deactivate the fader/effect.

To FADE IN

Push the joystick (**▲**) toward

[D.EFFECTS] ...

[CAMERA]: ...in record pause mode, then press **[START/STOP]** to start recording with a fade in.

[PLAY]: ...in playback pause mode, then press **[▶/II]** to fade in and start the playback.

To FADE OUT

Push the joystick (**▲**) toward

[D.EFFECTS] ...

[CAMERA]: ...while recording, then press **[START/STOP]** to fade out and pause the recording.

[PLAY]: ...during playback, then press **[▶/II]** to fade out and pause the playback.

To ACTIVATE AN EFFECT

Push the joystick (**▲**) toward

[D.EFFECTS] ...

[CAMERA]: ...while recording or in record pause mode.

[PLAY]: ...during playback.

[CAMERA]: ...and then press **[PHOTO]**, first halfway to activate the autofocus and then fully to record the still image.

Still Image Options

Erasing Still Images

IMPORTANT

Be careful when erasing images. Erased images cannot be recovered.

NOTES

Protected images cannot be erased.

Erasing a Single Image

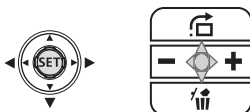

- 1 If the joystick guide does not appear on screen, press (SET) to display it.
- 2 Push the joystick (▼) toward ↕.
- 3 Select (◀▶) [ERASE] and press (SET).

Erasing a Single Image Just After Recording

You can erase the last recorded still image while reviewing it within the time set for the [REVIEW] option (or immediately after recording it, if [REVIEW] is set to [OFF OFF]).



While reviewing the image immediately after recording:

- 1 Push the joystick (▼) toward ↕.
- 2 Select (◀▶) [ERASE] and press (SET).

Erasing All Images

Protected images will not be deleted even if you erase all images.



FUNC.
(23)

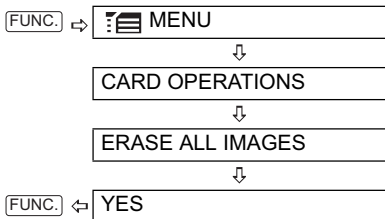
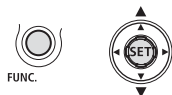

Protecting Still Images

You can protect still images from accidental erasure.



IMPORTANT

Initializing the memory card (65) will permanently erase all recorded still images, even the protected ones.

FUNC.
(23)



FUNC. → **PROTECT**

↓
Press (SET)

[**PROTECT**]: The image selection screen appears.

FROM THE IMAGE SELECTION SCREEN

- 1 Select (◀▶) the still image you want to protect.
- 2 Press (SET) to protect the still image.
[**PROTECT**] appears on the bottom bar and the image cannot be erased. Press (SET) again to cancel the image protection.
- 3 Repeat steps 1-2 to protect additional images or press **FUNC.** twice to close the menu.

Initializing the Memory Card

Initialize new memory cards when you use them for the first time. You may also choose to initialize a memory card to erase all the files in contains. The regular initialization option [INITIALIZE] will clear the file allocation table but will not physically erase the stored data. If you need to completely erase all the data, select instead the complete initialization option [COMPL.INIT.].

! IMPORTANT

- Initializing the memory card will erase all still images, even the protected ones. The original still images cannot be recovered.
- When you feel the time it takes to record on or read from the memory card has become too long, we recommend you select the complete initialization.
- The complete initialization may take a few minutes, depending on the capacity of the memory card.

- Initialize all memory cards before using them with this camcorder.

CAMERA CAMERA | PLAY PLAY (10)

FUNC.
(23)

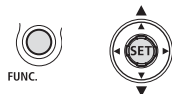

FUNC. → **MENU**

↓
CARD OPERATIONS

↓
INITIALIZE

↓
INITIALIZE

or

COMPL.INIT.

↓

FUNC. → **YES***



- * Press (SET) to cancel the complete initialization while it is in progress. All the image files will be erased and the memory card can be used without any problem.

Connecting to a TV or VCR

Connection Diagrams

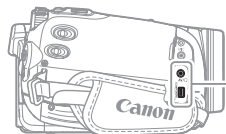

Turn off all the devices when making the connections and refer also to the instruction manual of the connected device.











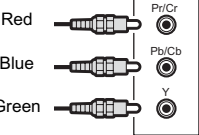

 AV/AVC	AV/AVC Terminal
 COMPONENT OUT	COMPONENT OUT Terminal The component video terminal is for video only. When you use connection type 1 do not forget the audio connections using the AV/AVC terminal.

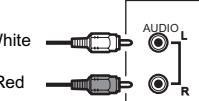

Open the terminal cover to access.

 HDV/DV	HDV/DV Terminal Check the type and orientation of the terminal and make sure you connect the DV cable properly.
 HDMI OUT	HDMI OUT Terminal The HDMI OUT terminal offers a high-quality digital connection that combines audio and video in a single convenient cable. Use only HDMI cables marked with the HDMI logo.

High Definition TV Sets (HDTV)

Terminal on the Camcorder	Connecting Cable	Terminal on the Connected Device
1 Output connection (Signal Flow →) to an HDTV with component video input terminals.		
 COMPONENT OUT	CTC-100/S Component Cable (Supplied)	 Red Pr/Cr Blue Pb/Cb Green Y
 AV/Ω	 STV-250N Stereo Video Cable (Supplied)	 White AUDIO L Red R
2 Output connection (Signal Flow →) to an HDTV with a DV (IEEE1394) terminal. Input connection (Signal Flow ←) from a TV or other digital video source with a DV (IEEE1394) output.		
 HDV/DV	DV Cable (Commercially available)	 4-pin
 HDV/DV		 6-pin*
* Be careful to correctly insert the 6-pin plug into the DV terminal. Inserting it in the wrong direction can result in damage to the camcorder.		
3 Output connection (Signal Flow →) to an HDTV with an HDMI terminal.		
 HDMI OUT	 HDMI cable (Commercially available)	

Standard Definition TV Sets

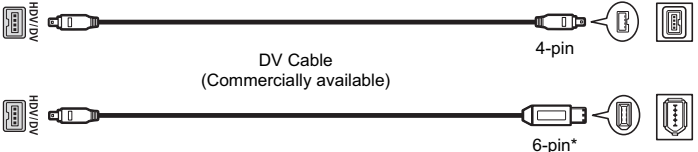
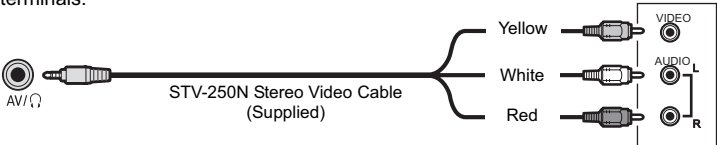
Terminal on the Camcorder	Connecting Cable	Terminal on the Connected Device
<p>2 Output connection (Signal Flow →) to a TV with a DV (IEEE1394) terminal. Input connection (Signal Flow ←) from a TV or other digital video source with a DV (IEEE1394) output.</p> 		
<p>4 Output connection (Signal Flow →) to a TV or VCR with AV Terminals. Input connection (Signal Flow ←) from a TV, VCR or other analog video source with AV terminals.</p> 		

* Be careful to correctly insert the 6-pin plug into the DV terminal. Inserting it in the wrong direction can result in damage to the camcorder.

Playback on a TV Screen

The quality of the playback picture will vary depending on the connected TV and the type of connection used.

POINTS TO CHECK



Change the following settings as necessary before making the connections. Refer to the corresponding explanation of each setting in the

▶ **PLAY/OUT SETUP** menu option list (□ 40).

- [PLAYBACK STD] to select the output video standard.
- [TV TYPE] to match the output video to the aspect ratio of the connected TV.
- [COMP.OUT] to select the video specifications when using connection type **1**.
- [DV OUTPUT] to select the standard of the output video when using connection type **2**.

Connecting

Connect the camcorder to the TV following one of the connection diagrams shown in the previous section *Connection Diagrams* (□ 66).

Playback

1 Turn on the camcorder and the connected TV or VCR.

On the TV: Select as the video input the same terminal to which you connected the camcorder. On the VCR: Set the input selector to the external video input (usually labeled LINE IN).

2 Start the playback of the movies (□ 29) or still images (□ 33).

NOTES

- Turn off all the devices before starting the connections.
- Sound from the built-in speaker will be muted while the STV-250N Stereo Video Cable is connected to the camcorder.
- We recommend powering the camcorder using the compact power adapter.
- If you connect to a TV using the HDMI connection –connection type **3**– or the video component connection –connection type **1**– you can enjoy the full resolution of high-definition TV.
- **About the HDMI terminal**
The HDMI (High-Definition Multimedia Interface) connection –connection type **3**– is a convenient all-digital connection using a single cable for both video and audio. When you connect the camcorder to an HDTV equipped with an HDMI terminal, you can enjoy video and audio playback at the highest quality.
 - The HDMI terminal on the camcorder is for output only. Do not connect it to an HDMI output terminal on an external device, as this may damage the camcorder.
 - The HDMI connection will recognize automatically the highest resolution supported by the connected HDTV, and output the optimal video signal to ensure the best viewing experience. You can confirm the current specification of the video output in the [HDMI OUT] information display at the bottom of the ▶▶ **PLAY/OUT SETUP2** menu screen in **PLAY** mode (▶▶ **PLAY/OUT SETUP** menu in other modes).
 - Correct operation cannot be guaranteed when connecting the camcorder to DVI monitors.
 - Some HDTVs have their HDCP digital content protection configured so as not to allow the playback of personal content (video recorded for personal uses). If you cannot play back the video recorded with this camcorder on your HDTV using the HDMI connection, try connecting the camcorder using the video component connection –connection type **1**– instead.
 - There will be no video output from the AV/Ω terminal or the COMPONENT OUT terminal while the camcorder is connected to an external device using the HDMI cable. In such case, only audio will be output from the AV/Ω terminal.

- There will be no video or audio output from the HDMI OUT terminal while there is a video input connection to the HDV/DV terminal or the AV/Ⓜ terminal.

- To output audio dubbed later on a tape through the HDMI OUT terminal, set [AUDIO OUT] to [Ⓜ MIX/VAR.] (□ 41).

- Audio output from the HDMI OUT terminal will include both channels (Left/Right on a stereo recording, Main/Sub on a bilingual recording), regardless of the [OUTPUT CH] setting.

Recording to a VCR or Digital Video Recorder

You can copy your recordings by connecting the camcorder to a VCR or a digital video device. When recording to a digital video recorder using the HDV/DV terminal, you can copy recordings with virtually no generation loss in video and sound quality.

Connect the camcorder to the external device following one of the connection diagrams shown in the previous section *Connection Diagrams* (□ 66).

POINTS TO CHECK



Change the following settings as necessary before making the connections. Refer to the corresponding explanation of each setting in the **▶ PLAY/OUT SETUP** menu option list (□ 40).

- [PLAYBACK STD] to select the output video standard.

- [DV OUTPUT] to select the standard of the output video when using connection type **2**. Note that the video standard of the recorded copy depends also on the standards supported by the external digital device. Refer to the table below.

- Set [AV/PHONES] to [Ⓜ AV] when using connection type **4**.

Connecting

Connect the camcorder to a VCR or other analog device using connection type **4**, or to a DVD recorder or other digital recording device using connection type **2**, as shown in the previous section *Connection Diagrams* (□ 66).

Settings for Recording Video Output using the HDV/DV Terminal

Video Output Signal	Standard of the Recording on the Tape	Standard Supported by the External Digital Device*	[PLAYBACK STD] Setting	[DV OUTPUT] Setting
High Definition	[HDV]	[HDV]	[A AUTO] or [HDV HDV]	[HDV/DV HDV/DV]
Standard Definition	[HDV]	[DV]	[A AUTO] or [HDV HDV]	[DV DV LOCKED]
	[DV]	[DV]	[A AUTO] or [DV DV]	[HDV/DV HDV/DV] or [DV DV LOCKED]

* To output video in high definition verify that the DV terminal on the external digital device is compatible with the MPEG2-TS protocol; to output video in standard definition, verify that it is compatible with the DV standard.

Recording

- 1 This camcorder: Load the recorded cassette.**
- 2 Connected device: Load a blank cassette or disc and set the device to record pause mode.**
- 3 This camcorder: Locate the scene you wish to copy and pause the playback shortly before the scene.**

When the connection is recognized "CAM HDV/DV" will be displayed. When the video output starts, the display will change to "CAM HDV-OUT" or "CAM DV-OUT" depending on the video output signal.

- 4 This camcorder: Resume the movie playback.**

When using an analog connection you can include in the copy the date, time and data code of the original recording, as well. Repeatedly press **[DISP.]** to change the on-screen display (**[] 57**).

- 5 Connected device: Begin recording when the scene you wish to copy appears. Stop recording when copying is complete.**
- 6 This camcorder: Stop playback.**

i NOTES

- We recommend powering the camcorder using the compact power adapter.
- When recording to a VCR using an analog connection –connection type **4** (**[] 66**)–, the quality of the edited tape will be lower than that of the original.
- When recording to a digital video recorder using the HDV/DV terminal –connection type **2** (**[] 66**)–:
 - If the picture does not appear, disconnect the DV cable and restore the connection after a short while or turn the camcorder off and then on again.

- Proper operation cannot be guaranteed for all digital devices equipped with a DV terminal. If the operation does not work, use the AV/Ⓜ terminal.

- You cannot record to an external device using the HDMI connection –connection type **3**–.

Analog Line-In Recording

You can input video from an analog video source (VCR, TV, etc.) and record the input video on the tape in the camcorder in DV standard. Analog video cannot be converted to HDV standard.



Connecting

Connect the camcorder to the video input source using an analog connection – connection type **4** (**[] 66**)– shown in the previous section *Connection Diagrams*.

Recording

Load a blank tape in the camcorder and load the recorded (source) tape or disc in the connected device.

FUNC.
(**[] 23**)



- 1 Press **[FUNC.]**.**
- 2 Select (**▲▼**) [**●** || REC PAUSE] and press (**SET**).**
- 3 Select (**◀▶**) [EXECUTE] and press (**SET**).**
- 4 Connected device: Start the playback.**

In record pause mode and while recording you can check the picture on the camcorder's screen.

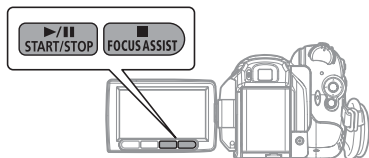

5 When the scene you wish to record appears, press **▶/||**.

Recording starts.

6 While recording, press **▶/||** to pause the recording.

In record pause, press **▶/||** again to resume recording.

7 Press **■** to stop recording.

8 Connected device: Stop the playback.

IMPORTANT

- Depending on the analog signal sent from the connected device the input image may be distorted or not be displayed at all (for example, video input that includes anomalous signals such as ghost signals).

- Analog video input that includes copyright protection signals cannot be recorded with this camcorder.

NOTES

We recommend powering the camcorder using the compact power adapter.

Digital Video Dubbing

You can input video from other digital video devices and record the input video on the tape in the camcorder. Video input will be recorded on the tape in the same standard of the original (HDV or DV).

POINTS TO CHECK



Set [PLAYBACK STD] to [**A** AUTO] (□ 40) before making the connections.

Connecting

Connect the camcorder to the video input source using the digital connection—connection type **2** (□ 66)—shown in the previous section *Connection Diagrams*.

Dubbing

1 Load a blank tape in the camcorder and load the recorded (source) tape in the connected device.

- If "AV → DV" appears on the screen, set [AV → DV] to [**OFF** OFF] (□ 39).
- When the connection is recognized "HDV/DV" will be displayed. When the video input starts, the display will change to "HDV-IN" or "DV-IN" depending on the video input signal.

FUNC.
(□ 23)



2 Press **FUNC.**

3 Select (**▲▼**) [**● || REC PAUSE**] and press (**SET**).

4 Select (**◀▶**) [**EXECUTE**] and press (**SET**).

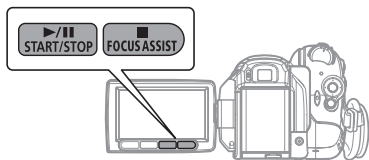

5 Connected device: Start the playback.

In record pause mode and while recording you can check the picture on the camcorder's screen.



6 When the scene you wish to record appears, press **▶/||**.

Recording starts.

- 7 **While recording, press  to pause the recording.**
In record pause, press  again to resume recording.
- 8 **Press  to stop recording.**
- 9 **Connected device: Stop the playback.**

! IMPORTANT

- Blank sections may be recorded as anomalous picture.
- If the picture does not appear, disconnect the DV cable and restore the connection after a short while or turn the camcorder off and then on again.
- Do not connect any devices to the camcorder's USB terminal while an external device is connected to the HDV/DV terminal.
- You can only record video signals in HDV standard (1080i specifications) or in DV standard. Note that signals from identically shaped DV (IEEE1394) terminals may be in different video standards.

i NOTES

We recommend powering the camcorder using the compact power adapter.

Copyright Signal

Certain software tapes are copyright protected. If you attempt to play back such tapes, "COPYRIGHT PROTECTED PLAYBACK IS RESTRICTED" appears and you will not be able to view the contents of the tape. If you attempt to record from such tapes via the HDV/DV terminal, "COPYRIGHT PROTECTED DUBBING RESTRICTED" appears and you will not be able to record the contents of the tape.

Analog/Digital Conversion

Using the camcorder you can convert analog video signals (for example from a VCR) to digital signals (DV standard only) and output them to a digital recording device.



Connecting

Connect the camcorder to the video input source using an analog connection –connection type **4** (□ 66)– shown in the previous section *Connection Diagrams*.

Connect the camcorder to the recording device using the digital connection –connection type **2** (□ 66)– shown in the same section. Verify that the DV terminal on the external digital device is compatible with the DV standard.

Converting the Video

FUNC.
(□ 23)

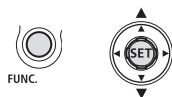

- 1 Set [AV → DV] to [ON ON] (□ 39).
- 2 **Start the playback on the video source and the recording on the recording device.**

Refer to the instruction manuals of the connected devices.

! IMPORTANT

- Depending on the signal sent from the connected device, the conversion from analog to digital signals might not work properly (e.g., signals that include copyright protective signals or anomalous signals such as ghost signals).
- Usually, leave [AV → DV] set to the default setting [OFF OFF]. While it is set to [ON ON], you cannot connect video input signals to the camcorder using the HDV/DV terminal.

i NOTES

- We recommend powering the camcorder using the compact power adapter.
- You can also use the analog/digital conversion to transfer analog video recordings to a computer as digital video. The required equipment and operation is the same as described in *Transferring Video Recordings* (□ 76) except in this case you need to set [AV → DV] to [**ON** ON] before connecting the camcorder to the computer. Note that the analog/digital conversion may not work correctly depending on the software and the specifications/settings of the computer.

Connecting to a Computer

PC Connection Diagrams

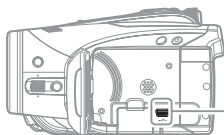





USB Terminal

Open the LCD panel cover to access.

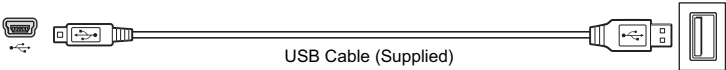

HDV/DV Terminal

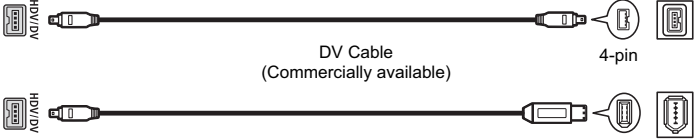
Check the type and orientation of the terminal and make sure you connect the DV cable properly.

Terminal on the Camcorder	Connecting Cable	Terminal on the Connected Device
1 Output connection (Signal Flow →) to a PC or PictBridge compatible printer with an USB port.	 <p style="text-align: center;">USB Cable (Supplied)</p>	
2 Output connection (Signal Flow →) to a computer with a DV (IEEE1394) terminal or a DV capture board.	 <p style="text-align: center;">DV Cable (Commercially available)</p>	 4-pin  6-pin*
<p>* Be careful to correctly insert the 6-pin plug into the DV terminal. Inserting it in the wrong direction can result in damage to the camcorder.</p>		

Transferring Video Recordings

You can transfer recordings to a computer using the HDV/DV terminal.



Equipment and System Requirements

- A computer equipped with an IEEE1394 (DV) terminal or an IEEE1394 (DV) capture board
- A DV cable (commercially available)
- Video editing software
- The appropriate driver

The standard of the video transferred depends on the standard of the original recording and the compatibility of the video editing software.

When transferring a video originally recorded in HDV standard, if the editing software supports high-definition video, video output will be in HD standard. If the editing software does not support high-definition video, even if the original recording was made in HDV standard, video output will be in SD standard.

POINTS TO CHECK

Change the following settings as necessary before making the connections. Refer to the corresponding explanation of each setting in the **PLAY/OUT SETUP** menu option list (40).

- [PLAYBACK STD] and [DV OUTPUT] to select the standard of the output video. Note that the video standard of the transferred video depends also on the standards supported by the computer.
- [AV \Rightarrow DV] to select whether to transfer recordings from the tape in the camcorder (set to [OFF OFF]) or video converted from an external analog source (set to [ON ON]).

Connecting

- 1 Start the computer.
- 2 Set the camcorder to mode.
- 3 Connect the camcorder to the computer using the digital connection –connection type (75)– shown in the previous section **PC Connection Diagrams**. When the connection is recognized “ HDV/DV” will be displayed.
- 4 Start the video editing software. Refer to the instruction manual of the editing software.

IMPORTANT

- The video transfer may not work correctly depending on the software and the specifications/settings of your computer.
- If the computer freezes while the camcorder is connected to it, disconnect the DV cable and turn off the camcorder and the computer. After a short while, turn them on again, set the camcorder to mode and restore the connection.
- Before connecting the camcorder to the computer using a DV cable, make sure that the camcorder and computer are not connected with a USB cable, and that no other IEEE1394 device is connected to the computer.
- Depending on the video editing software, you may need to set the **POWER** switch of the camcorder to a mode other than PLAY. Refer to the instruction manual of the editing software.

NOTES

- We recommend powering the camcorder using the compact power adapter.
- Refer also to the instruction manual of the computer.
- The programs ZoomBrowser EX and Image Browser included with the supplied CD-ROM can only be used to transfer still images recorded on the memory card. Video recordings on the tape cannot be transferred to the computer using the software included with the supplied CD-ROM.

Transferring Still Images – Direct Transfer

With the supplied USB cable and the Digital Video Software, you can transfer still images to a computer simply by pressing  (print/share).



Preparations

The first time you connect the camcorder to the computer, you need to install the software and set the auto-launch setting. From the second time on, you will only need to connect the camcorder to the computer to transfer images.

1 Install the supplied Digital Video Software.

Refer to the installation guide (separate leaflet included with the CD-ROM).

2 Set the camcorder to mode.

3 Connect the camcorder to the computer using the USB connection –connection type (75)– shown in the previous section **PC Connection Diagrams**.



See *Connecting the Camcorder to a Computer* in the *Digital Video Software* instruction manual (electronic version on PDF file).

4 Set the auto-launch setting.

- See *Starting CameraWindow* (Windows) or *Auto-downloading* (Macintosh) in the *Digital Video Software* instruction manual (electronic version on PDF file).

- The direct transfer menu appears on the camcorder screen and the  button lights up.





! IMPORTANT

- When the CARD access indicator is on or flashing do not perform the following actions. Doing so may result in permanent data loss.
 - Do not open the memory card slot cover and do not remove the memory card.
 - Do not disconnect the USB cable.
 - Do not turn off the camcorder or the computer.
 - Do not change the position of the  /  switch or the operating mode.
- Operation may not work correctly depending on the software and the specifications/settings of your computer.
- The image files on your memory card are valuable, original data files. If you wish to use the image files on your computer, make copies of them first, and use the copied file, retaining the original.

i NOTES

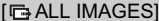
- We recommend powering the camcorder using the compact power adapter.
- Refer also to the computer's instruction manual.
- Users of Windows XP and Mac OS X: Your camcorder is equipped with the standard Picture Transfer Protocol (PTP) allowing you to download still images (JPEG only) simply by connecting the camcorder to a computer using the USB cable without installing the software from the supplied software CD-ROM.

Transferring Images

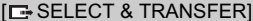
 ALL IMAGES
Transfers all images to the computer.
 NEW IMAGES
Transfers only those images that have not yet been transferred to the computer.
 TRANSFER ORDERS
Transfers images with transfer orders ( 78) to the computer.
 SELECT & TRANSFER
Allows you to select the still image you want to transfer to the computer.

[WALLPAPER]

Allows you to select the still image you want to transfer and set it as your computer's desktop background.

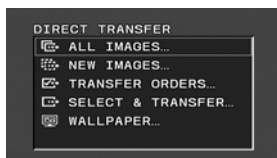
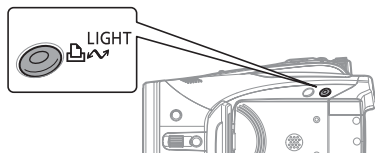

AUTOMATIC TRANSFER OPTIONS

When you select [ALL IMAGES], [NEW IMAGES] or [TRANSFER ORDERS], all the relevant still images will be transferred to the computer in one batch and their thumbnails will be displayed on the computer.

Select (▲▼) a transfer option and press (▶◀).

- The images are transferred and displayed on the computer.
- The camcorder returns to the transfer menu once the transfer is complete.
- To cancel the transfer, select (◀▶) [CANCEL] and press (SET) or press [FUNC.].

MANUAL TRANSFER OPTIONS

When you select [SELECT & TRANSFER] or [WALLPAPER] you can select the images you want to transfer one by one.

- 1 Select (▲▼) a transfer option and press (▶◀).
- 2 Select (◀▶) the image you want to transfer and press (▶◀).

- [SELECT & TRANSFER]: The selected image is transferred and displayed on the computer. To continue transferring, select (◀▶) another image.
- [WALLPAPER]: The selected image is transferred to the computer and displayed as the desktop's background.
- The (▶◀) button will flash while the images are being transferred.
- Press [FUNC.] to return to the transfer menu.

NOTES

- You can press (SET) to transfer the images, instead of (▶◀). With the automatic transfer options, a confirmation message appears. Select [OK] and press (SET).
- When the camcorder is connected to the computer and the image selection screen is displayed, press [FUNC.] to return to the transfer menu.

Transfer Orders

You can mark the still images you want to transfer to the computer as transfer orders. You can set transfer orders for up to 998 still images.

Selecting Still Images to Transfer (Transfer Order)

Set the transfer orders in advance, before connecting the camcorder to the computer using the USB cable.



FUNC.
(23)



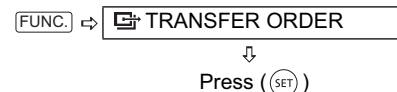

: The image selection screen appears.

FROM THE IMAGE SELECTION SCREEN

- 1 Select () () the still image you want to mark with a transfer order.
- 2 Press () to set the transfer order. A checkmark appears in the box next to the transfer order symbol . Press () again to cancel the transfer order.
- 3 Repeat steps 1-2 to mark additional images with transfer orders or press twice to close the menu.

Erasing All Transfer Orders



FUNC.
(23)

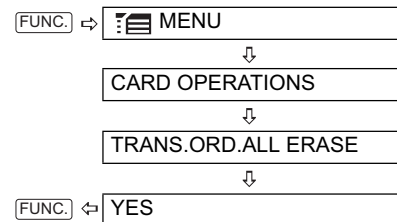

Connecting to a Printer

Printing Still Images - Direct Print

The camcorder can be connected to any PictBridge compatible printer. You can mark the still images you want to print and set the desired number of copies as a print order (82).

Canon printers: SELPHY printers of the CP, DS and ES series and PIXMA printers marked with the PictBridge logo.



Connecting the Camcorder to the Printer



- 1 Insert the memory card containing the still images you want to print.
- 2 Turn on the printer.
- 3 Connect the camcorder to the printer using the **USB connection** -connection type (75)- shown in the previous section **PC Connection Diagrams**.

- appears and changes to .
- The (print/share) button lights up and the current print settings will be displayed for approx. 6 seconds.

IMPORTANT

If continues to flash (for more than 1 minute) or if does not appear, the camcorder is not correctly connected to the printer. In such case, disconnect the USB cable and turn off the camcorder and the printer. After a short while, turn them on again, set the camcorder to mode and restore the connection.

NOTES



- will appear for images that cannot be printed.

- We recommend powering the camcorder using the compact power adapter.
- Refer also to the printer's instruction manual.

Printing with the (Print/Share) Button

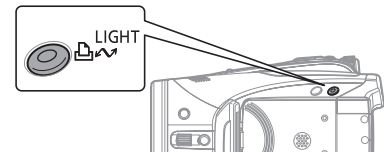
You can print a still image without changing the settings simply by pressing .



- 1 Select (◀▶) the still image you wish to print.
- 2 Press .
 - Printing starts. The  button flashes and stays on when the printing is completed.
 - To continue printing, select (◀▶) another still image.

Selecting the Print Settings

You can select the number of copies and other settings for printing. The setting options vary depending on your printer model.

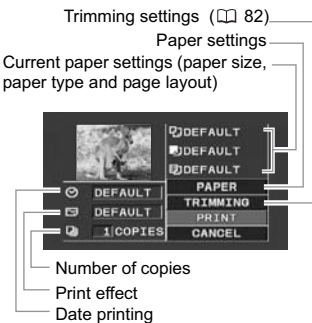

Options

[PAPER]

[] PAPER SIZE

Available paper sizes vary depending on the printer model.

[] PAPER TYPE

Select [PHOTO], [FAST PHOTO] or [DEFAULT].

[] PAGE LAYOUT

Select [DEFAULT] or one of the following available page layouts.

[BORDERED]: Prints the whole image area almost exactly as the recorded still image.

[BORDERLESS]: Enlarges the center portion of the still image to fit the width/height ratio of the selected paper size. The top, bottom and sides of the still image may be slightly trimmed out.

[2-UP], [4-UP], [8-UP], [9-UP], [16-UP]: Prints multiple small copies of the same still image on one sheet of paper.

[] (Date print)

Select [ON], [OFF] or [DEFAULT].

[] (Print Effect)

The print effect can be used with printers compatible with the Image Optimize function to achieve higher quality prints. Select [ON], [OFF] or [DEFAULT].

Canon PIXMA/SELPHY DS printers: You can also select [VIVID], [NR] and [VIVID+NR].

[] (Number of Copies)

Select 1-99 copies.

NOTES

Print setting options and [DEFAULT] settings vary depending on the printer model. For details, refer to the printer's instruction manual.

Printing after Changing the Print Settings



- If the joystick guide does not appear on screen, press (SET) to display it.**
- Push the joystick (▼) toward ▾.**
 - The print setting menu appears.
 - Depending on the printer, the message "BUSY." may appear before the camcorder displays the print setting menu.
- In the print settings menu, select (▲▼, ◀▶) the setting you want to change and press (SET).**
- Select (▲▼) the desired setting option and press (SET).**
- Select (▲▼, ◀▶) [PRINT] and press (SET).**
 - Printing starts. The print setting menu disappears when the printing is completed.
 - To continue printing, select another still image.

TO CANCEL THE PRINTING

Press (SET) while printing. A confirmation dialog appears. Select [OK] and press (SET). With Canon's PictBridge compatible printers, the printing will stop immediately (even if not completed) and the paper will be fed through.

PRINTING ERRORS

If an error occurs during the printing process, an error message appears (□ 89).

- Canon's PictBridge compatible printers: Resolve the error. When printing does not resume automatically, select [CONTINUE] and press (SET). If [CONTINUE] cannot be selected, select [STOP], press (SET) and retry printing. Refer also to the printer's instruction manual for details.

- If the error still persists and printing does not restart, disconnect the USB cable and turn off the camcorder and the printer. After a short while, turn them on again, set the camcorder to **PLAY-LE** mode and restore the connection.

WHEN YOU HAVE FINISHED PRINTING

Disconnect the cable from the camcorder and printer and turn off the camcorder.

IMPORTANT

- The following still images may not be correctly printed with a PictBridge compatible printer.
 - Images created or changed on a computer and transferred to the memory card.

Printing Multiple Images on the Same Sheet



When using Canon printers, you can print the same still image multiple times on the same sheet of paper. Use the following table as a guideline for the recommended [PAGE LAYOUT] settings depending on the [PAPER SIZE] setting.

[PAPER SIZE] → Canon Printer Series ↓	[CREDITCARD]	[9 x 13 cm]	[10 x 14.8 cm]	[A4]
PIXMA SELPHY DS	–	–	2-, 4-, 9- or [16-UP] ¹	[4-UP]
SELPHY CP	2-, 4- or [8-UP] ²	2- or [4-UP]	2- or [4-UP]	–
SELPHY ES	2-, 4- or [8-UP] ³	2- or [4-UP]	2- or [4-UP]	–

¹ You can also use the special photo sticker sheets.





² When you use the wide-sized photo paper with the [DEFAULT] setting, you can also use [2-UP] or [4-UP].

³ With the [8-UP] setting, you can also use the special photo sticker sheets.

- Images recorded with the camcorder but edited on a computer.
- Images whose file names were changed.
- Images not recorded with this camcorder.
- Observe the following precautions during printing:
 - Do not turn off the camcorder or the printer.
 - Do not change the position of the  /  switch.
 - Do not disconnect the USB cable.
 - Do not remove the memory card.
- If the message "BUSY." does not disappear, disconnect the USB cable and restore the connection after a short while.

Trimming Settings

Set the paper size and page layout before changing the trimming settings.

- 1 In the print setting menu ( 80), select ( , ) [TRIMMING] and press ().**

The trimming frame appears.



- 2 Change the size of the trimming frame.**

- Move the zoom lever toward **T** to shrink the frame, and toward **W** to enlarge it. Press () to change the orientation of the frame (portrait/landscape).
- To cancel the trimming settings, move the zoom lever toward **W** until the trimming frame disappears.



- 3 Move ( , ) the trimming frame.**

- 4 After setting the trimming frame, press () to return to the print menu.**

NOTES

- About the color of the trimming frame:
 - White: No trimming settings.
 - Green: Recommended trimming size. The size of the trimming frame may differ depending on the image size, paper size or borders settings.
- The trimming setting applies only to one image.
- The trimming setting is canceled in the following cases:
 - When you turn off the camcorder.
 - When you disconnect the USB cable.
 - When you expand the trimming frame beyond its maximum size.
 - When you change any of the [PAPER] settings.
- You may not be able to set the trimming settings for a still image not recorded with this camcorder.

Print Orders

You can mark the still images you want to print and set the desired number of copies as a print order. These print orders are compatible with the Digital Print Order Format (DPOF) standards and can be used for printing on DPOF compatible printers ( 79). You can set print orders for up to 998 still images.

Selecting Still Images for Printing (Print Order)

Do not connect the USB cable to the camcorder while setting the print orders.



FUNC.
(23)

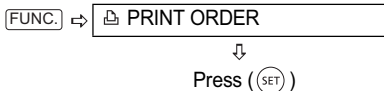

0: The image selection screen appears.

FROM THE IMAGE SELECTION SCREEN

- 1 Select (◀▶) the still image you want to mark with a print order.
- 2 Press (SET) to set the print order. The number of copies appears in orange in the box next to the print order symbol .
- 3 Set (▲▼) the number of copies desired and press (SET). To cancel the print order, set (▲▼) the number of copies to 0.
- 4 Repeat steps 1-3 to mark additional images with print orders or press **FUNC.** twice to close the menu.

Printing the Still Images Marked with Print Orders

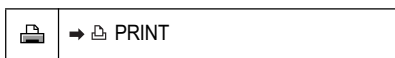

FUNC.
(23)



- 1 Connect the camcorder to the printer using the USB connection – connection type (75) – shown in the previous section **PC Connection Diagrams**.
- 2 Press **FUNC.**, select (▲▼) the icon and press (SET) to open the setup menus.

3 Select (▲▼) [PRINT] and press (SET).

- The print setting menu appears.
- The error message “SET PRINT ORDER” appears if you connect a printer with direct print function and select [PRINT] without having set any print orders beforehand.

4 Make sure that [PRINT] is selected and press (SET).

Printing starts. The print setting menu disappears when the printing is completed.

NOTES

- Depending on the connected printer, you can change some print settings before step 4 (80).
- **Cancel Printing/Printing Errors** (81)
- **Restarting Printing:** Open the print settings menu as explained in steps 2-3 above. In the print settings menu, select [RESUME] and press (SET). The remaining images will be printed. Printing cannot be restarted when the print order settings have been changed or if you deleted a still image with print order settings.

Erasing All Print Orders



FUNC.
(23)

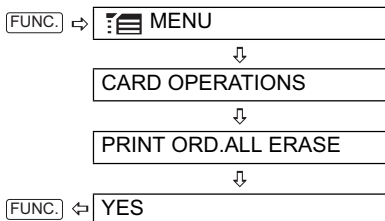
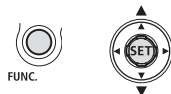





Troubleshooting



If you have a problem with your camcorder, refer to this checklist. Consult your dealer or a Canon Service Center if the problem persists.

Power Source



Problem	Solution	
<ul style="list-style-type: none"> • Camcorder will not turn on. • The camcorder switches off by itself. • The cassette compartment cover will not open. • The LCD/viewfinder switches on and off. 	Battery pack is exhausted. Replace or charge the battery pack.	18
	Attach the battery pack correctly.	
The charge indicator flashes rapidly (about twice per second).	Charging has stopped because the compact power adapter or the battery pack is faulty.	–
<ul style="list-style-type: none"> • Battery pack will not charge. • The charge indicator flashes very slowly (about once every 2 seconds). 	Charge the battery pack in temperatures between 0 °C and 40 °C (32 °F and 104 °F).	–
	Battery packs become hot with use and may not charge. When the battery pack is outside the charging temperature range, the CHARGE (charge) indicator will flash irregularly. The charging will start once the battery pack temperature is below 40 °C (104 °F).	–
	The battery pack is damaged. Use a different battery pack.	–

Recording/Playback





Problem	Solution	
Buttons will not work.	Turn on the camcorder.	–
	Load a cassette.	20
Abnormal characters appear on the screen. The camcorder does not operate properly.	Disconnect the power source and reconnect it after a short time. If the problem still persists, disconnect the power source and press the RESET button with a pointed item. Pressing the RESET button resets all settings.	–
"  " flashes on the screen.	Load a cassette.	20
"  " flashes on the screen.	Battery pack is exhausted. Replace or charge the battery pack.	18
"  " flashes on the screen.	Condensation is detected. See reference page.	94
The lens cover is not completely open.	Turn the camcorder off and then on again.	–
"  " flashes red on the screen.	The camcorder malfunctions. Consult a Canon Service Center.	–
"REMOVE THE CASSETTE" appears on the screen.	Remove the cassette and reinsert it.	20
The wireless controller will not work.	Set [WL.REMOTE] to [ON].	44
	The battery of the wireless controller is exhausted. Replace the battery.	21

Problem	Solution	
Video noise appears on screen.	When using the camcorder in a room where a plasma TV is located, keep a distance between the camcorder and the plasma TV.	–
Video noise appears on the TV screen.	When using the camcorder in a room where a TV is located, keep a distance between the compact power adapter and the power or antenna cables of the TV.	–
The tape stops during record pause or playback pause.	To protect the tape and video heads, the camcorder will enter the stop mode (■) if left in playback pause (▶) or record pause (●) mode for 4 minutes 30 seconds. To resume the playback press [START/STOP] (when recording) or [▶] (during playback).	–
Horizontal bands appear on the screen.	This is a phenomenon typical of CMOS image sensors when recording under some types of fluorescent, mercury or sodium lamps. To reduce the symptoms set the mode switch to  .	–
When a subject flits across in front of the lens, the image appears slightly bent.	This is a phenomenon typical of CMOS image sensors. When a subject crosses very quickly in front of the camcorder, the image may seem slightly warped.	–



Recording

Problem	Solution	
Image will not appear on the screen.	Set the camcorder to  .	26
"SET THE TIME ZONE, DATE AND TIME" appears on the screen.	Set the time zone, date and time.	24
	Recharge the built-in lithium battery and set the time zone, date and time.	93
Pressing the START/STOP button will not start recording.	Set the camcorder to  .	26
	Load a cassette.	20
	Tape reached the end ("END" appears on the screen). Rewind the tape or replace the cassette.	20
	Cassette is protected ("P" flashes on the screen). Change the position of the protect switch.	92
Camcorder will not focus.	Autofocus does not work on that subject. Focus manually.	49
	If you are using the viewfinder, adjust it with the dioptic adjustment lever.	21
	Lens is dirty. Clean the lens with a soft lens-cleaning cloth. Never use tissue paper to clean the lens.	94
	If you are using the optional Wide-converter or Tele-converter, set [AF MODE] to [NORMAL AF].	37
Sound is distorted.	When recording near loud sounds (such as fireworks or concerts), sound may become distorted.	–
	You may be able to record the audio correctly by manually adjusting the audio recording level or by setting [MIC ATT.] to [ON].	61
Viewfinder picture is blurred.	Adjust the viewfinder with the dioptic adjustment lever.	21



Playback

Problem	Solution	
During playback there is video noise.	Video heads are dirty. Clean the video heads.	94
Pressing the playback button does not start playback.	Load a cassette.	20
	Set the camcorder to  .	29
	Tape reached the end ("END" appears on the screen). Rewind the tape.	20
No sound from the built-in speaker.	Open the LCD panel.	—
	Speaker volume is turned off. Adjust the volume with the joystick and joystick guide in  mode.	30
When playing back a tape recorded in HDV standard the playback is jerky or the sound stutters on and off.	Video heads are dirty. Clean the video heads.	94
Image will not appear on the TV screen.	Set [AV → DV] to [OFF].	39
	Set [AV/PHONES] to [ AV].	30
	Check again that the camcorder is properly connected to the TV.	66
	When connecting the camcorder to an HDTV using the CTC-100/S Component Cable, make sure to select the correct specification for the [COMP.OUT] setting.	42
There is no sound from the TV.	When connecting the camcorder to an HDTV using the CTC-100/S Component Cable, make sure to connect also the audio connections using the white and red plugs of the STV-250N Stereo Video Cable.	66
Text displays do not appear on the TV.	If you connected the camcorder to the TV using the video component connection, set [DV OUTPUT] to [HDV/DV].	42
Tape is running, but image will not appear on the TV screen.	The video input on the TV is not set to the video terminal to which you connected the camcorder. Select the correct video input.	69
	Video heads are dirty. Clean the video heads.	94
	You attempted to play back or dub a copyright protected tape. Stop playback/dubbing.	73
The camcorder is connected using the HDMI cable, but there is no picture or sound from the HDTV.	Video input from the HDV/DV terminal cannot be output through the HDMI OUT terminal.	69
	This may happen when playing back a tape that contains mixed recordings in different standards (HDV/DV). Disconnect the HDMI cable and then restore the connection or turn the camcorder off and then on again.	—



Memory Card Operation

Problem	Solution	
Memory card cannot be inserted.	Memory card was not facing the correct direction. Turn the memory card over and reinsert it.	20
Cannot record on the memory card.	Memory card is full. Erase still images to free some space or replace the memory card.	64
	Memory card was not initialized. Initialize the memory card.	65
	The folder and file numbers have reached their maximum value. Set [FILE NOS.] to [RESET] and insert a new memory card.	40
Memory card cannot be played back.	Set the camcorder to  .	33
Image cannot be erased.	Image is protected. Cancel the protection.	64
"  " flashes in red.	Card error occurred. Turn off the camcorder. Remove and reinsert the memory card. Initialize the memory card if flashing persists.	65

Printing

Problem	Solution	
The printer is not operating even though the camcorder and printer are correctly connected.	Disconnect the USB cable and turn off the camcorder and the printer. After a short while, turn them on again, set the camcorder to  mode and restore the connection.	–

Editing

Problem	Solution	
Cannot record with this camcorder video input from an external video device connected to the HDV/DV terminal using a DV cable.	Set [AV → DV] to [OFF].	39
	Wrong signal standard. Refer also to the instruction manual of the connected device. Dubbing may work using the AV/  terminal.	–

Others

Problem	Solution	
A rattling can be heard from the camcorder.	The internal lens fixture can move when the camcorder is turned off. This is not a malfunction.	–

List of Messages

Some error messages will disappear after being displayed for about 4 seconds.

Message	Explanation/Solution	
SET THE TIME ZONE, DATE AND TIME	You have not set the time zone, date and time. This message appears each time you turn the power on until you set the time zone, date and time.	24
CHANGE THE BATTERY PACK	Battery pack is exhausted. Replace or charge the battery pack.	18
THE TAPE IS SET FOR ERASURE PREVENTION	Cassette is protected. Replace the cassette or change the position of the protect switch.	92
REMOVE THE CASSETTE	Camcorder stopped operating to protect the tape. Remove the cassette and reinsert it.	20
CHECK THE HDV/DV INPUT (Appears only if a DV cable is connected)	The DV cable is not correctly connected to the HDV/DV terminal, or the connected digital device is turned off. The video input signal is in a different television system (PAL or SECAM).	66 –
CONDENSATION HAS BEEN DETECTED	Condensation has been detected in the camcorder.	94
CONDENSATION HAS BEEN DETECTED REMOVE THE CASSETTE	Condensation has been detected in the camcorder. Remove the cassette.	94
TAPE END	Tape reached the end. Rewind the tape or replace the cassette.	–
INCORRECT TAPE SPECIFICATION	You attempted to play back a tape recorded in a different television system (PAL or SECAM) or in a recording standard not supported by this camcorder.	–
INPUT SIGNAL NOT SUPPORTED	The digital device connected with the DV cable is incompatible with the camcorder.	–
PLAYBACK STD LOCKED INCOMPATIBLE VIDEO INPUT	Current camcorder settings do not match the HDV/DV standard of the video input signal. Change the [PLAYBACK STD] setting to match the video input signal.	40
PLAYBACK STD LOCKED PLAYBACK IS RESTRICTED	Current camcorder settings do not match the HDV/DV standard of the recording you tried to play back. Change the [PLAYBACK STD] to match the recording standard of the tape.	40
HEADS DIRTY, USE CLEANING CASSETTE	Video heads are dirty. Clean the video heads.	94
NO CARD	There is no memory card in the camcorder.	20
NO IMAGES	No images are recorded on the memory card.	–
CARD ERROR	A memory card error occurred. The camcorder cannot record or display the image. The error may be temporary. If the message disappears after 4 seconds and "□" flashes red, turn the camcorder off, remove the card and reinsert the card. If "□" changes to green or yellow, you can continue recording/playback.	–
CARD FULL	Memory card is full. Erase some images to free some space or replace the memory card.	64





Message	Explanation/Solution	
IN CARD POSITION	You pressed [START/STOP] while recording still images (CAMERA mode).	–
NAMING ERROR	The folder and file numbers have reached their maximum value. Set the [FILE NOS.] option to [RESET] and erase all the images on the memory card or initialize it.	64 65
UNIDENTIFIABLE IMAGE	The image file is corrupted or it was saved using a compression method other than that compatible with this camcorder (JPEG).	–
TRANSFER ORDER ERROR	You attempted to set more than 998 transfer orders.	78
PRINT ORDER ERROR	You attempted to set more than 998 still images in the print order.	82
CANNOT TRANSFER!	You attempted to transfer a still image that cannot be displayed with this camcorder.	–
TOO MANY STILL IMAGES DISCONNECT USB CABLE	Disconnect the USB cable and decrease the number of still images on the memory card to less than 1800. If a dialog appeared on the computer screen, close it and then restore the connection.	–
COPYRIGHT PROTECTED PLAYBACK IS RESTRICTED	You attempted to play back a copyright protected tape.	73
COPYRIGHT PROTECTED DUBBING RESTRICTED	You attempted to dub a copyright protected tape. May also appear when an anomalous signal is received during analog line-in recording.	73

Direct Print Related Messages

NOTES

About Canon PIXMA/SELPHY DS Printers: If the printer's error indicator flashes or an error message appears on the printer's operation panel, refer to the printer's instruction manual.

Message	Explanation/Solution
PAPER ERROR	There is a problem with the paper. The paper is not correctly loaded or the paper size is wrong. Alternatively, if the paper output tray is closed, open it to print.
NO PAPER	Paper is not correctly inserted or there is no paper.
PAPER JAM	The paper jammed during printing. Select [STOP] to cancel printing. After removing the paper, set some paper again and retry printing.
INK ERROR	There is a problem with the ink.
NO INK	The ink cartridge is not inserted or is out of ink.
LOW INK LEVEL	The ink cartridge needs to be replaced soon. Select [CONTINUE] to restart printing.
INK ABSORBER FULL	Select [CONTINUE] to resume printing. Contact a Canon Service Center (refer to the list included with the printer) to replace the ink absorber.
• FILE ERROR • CANNOT PRINT!	You attempted to print an image that was recorded with another camcorder, with a different compression, or was edited on a computer.

Message	Explanation/Solution
SET  PRINT ORDER	No still image on the memory card has been marked with a print order.
READJUST TRIMMING	You changed the print style after you set the trimming settings.
PRINTER ERROR	Cancel printing. Turn the printer off and then on again. Check the printer status. If the error still persists, refer to the printer's instruction manual and contact the appropriate customer support center or service center.
HARDWARE ERROR	Cancel printing. Turn the printer off and then on again. Check the printer status. If the printer is equipped with a battery, it might be exhausted. In such case, turn off the printer, replace the battery and turn it back on.
COMMUNICATION ERROR	The printer is experiencing a data transfer error. Cancel printing. Disconnect the USB cable and turn off the camcorder and the printer. After a short while, turn them on again, set the camcorder to  mode and restore the connection. When you are printing using the  button, check the print settings. Or, you attempted to print from a memory card that contains a large number of images. Reduce the number of images.
CHECK PRINT SETTINGS	The print setting cannot be used for printing with the  button.
PRINTER IN USE	The printer is in use. Check the printer status.
PAPER LEVER ERROR	Paper lever error occurred. Adjust the paper selection lever to the proper position.
PRINTER COVER OPEN	Close the printer cover securely.
NO PRINTHEAD	No print head is installed in the printer or the print head is defective.

Handling Precautions

Camcorder

- Do not carry the camcorder by the LCD panel. Be careful when closing the LCD panel.
- Do not leave the camcorder in places subject to high temperatures (like the inside of a car under direct sunlight), or high humidity.
- Do not use the camcorder near strong electric or magnetic fields such as above TVs, near plasma TVs or mobile phones.
- Do not point the lens or viewfinder at strong light sources. Do not leave the camcorder pointed at a bright subject.
- Do not use or store the camcorder in dusty or sandy places. The camcorder is not waterproof – avoid also water, mud or salt. If any of the above should get into the camcorder it may damage the camcorder and/or the lens.
- Be careful of heat generated by lighting equipment.
- Do not disassemble the camcorder. If the camcorder does not function properly, consult qualified service personnel.
- Handle the camcorder with care. Do not subject the camcorder to shocks or vibration as this may cause damage.

Battery Pack

DANGER!

Treat the battery pack with care.

- Keep it away from fire (or it might explode).
- Do not expose it to temperatures higher than 60 °C (140 °F). Do not leave it near a heater or inside a car in hot weather.
- Do not try to disassemble or modify it.
- Do not drop or knock it.
- Do not get it wet.

- Charged battery packs continue to discharge naturally. Therefore, charge them on the day of use, or the day before, to ensure a full charge.
- Attach the terminal cover whenever a battery pack is not in use. Contact with metallic objects may cause a short circuit and damage the battery pack.
- Dirty terminals may cause a poor contact between the battery pack and the camcorder. Wipe the terminals with a soft cloth.
- Since storing a charged battery pack for a long time (about 1 year) can shorten its lifecycle or affect performance, we recommend to discharge the battery pack fully and to store it in a dry place at temperatures no higher than 30 °C (86 °F). If you do not use the battery pack for long periods, charge and discharge it fully at least once a year. If you have more than one battery pack, perform these precautions at the same time for all battery packs.
- Although the battery pack's operating temperature range is from 0 °C to 40 °C (32 °F to 104 °F), the optimal range is from 10 °C to 30 °C (50 °F to 86 °F). At cold temperatures, performance will temporarily decline. Warm it in your pocket before use.

- Replace the battery pack if the usable time after full charge diminishes substantially at normal temperatures.

About the battery terminal cover

The battery terminal cover has a [□]-shaped hole. This is useful when you wish to differentiate between charged and uncharged battery packs.

Back side of the battery pack

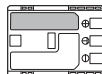

Terminal cover attached
Charged



Uncharged

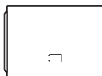

Cassette

- Rewind tapes after use. A slack or damaged tape may cause video problems and/or audio distortions during playback.
- Return cassettes to the case and store them upright. Rewind tapes from time to time if they are stored for a long time.
- Do not leave the cassette in the camcorder after use.
- Do not use spliced tapes or nonstandard cassettes as they may damage the camcorder.
- Do not use tapes that have been jammed as video heads may become dirty.
- Do not insert anything into the small holes of the cassette, or cover them with cellophane tape.
- Handle cassettes with care. Do not drop or subject them to severe impact as this may damage the cassettes.

- With cassettes equipped with a memory function, metal plated terminals may become dirty with use. Clean the terminals with a cotton swab after about 10 times of removing and reinserting the cassette. The memory function is not supported by the camcorder.

Protecting Tapes from Accidental Erasure

To protect your recordings from accidental erasure, slide the tab on the cassette to SAVE or ERASE OFF.

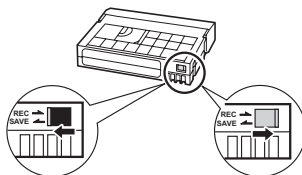

Memory Card

- We recommend saving backups of memory card images on your computer. Image data may be corrupted or lost due to memory card defects or exposure to static electricity. Canon Inc. makes no warranties for corrupted or lost data.
- Do not turn off the camcorder, disconnect the power source or remove the memory card while the CARD access indicator is flashing.
- Do not use memory cards in places subject to strong magnetic fields.
- Do not leave memory cards in places subject to high humidity and high temperature.
- Do not disassemble, bend, drop, or subject memory cards to shocks and do not expose them to water.
- Do not touch or expose the terminals to dust or dirt.
- Check the direction before inserting the memory card. Forcing a memory card into

the slot if it is not correctly oriented may damage the memory card or the camcorder.

- Do not attach any labels or stickers on the memory card.
- When you erase image files or initialize the memory card, only the file allocation table is altered and the data itself is not actually deleted. Take the necessary precautions when you dispose of the memory card, for example by physically damaging it to prevent the leakage of private data.

Lithium Button Battery

WARNING!

- The battery used in this device may present a fire or chemical burn hazard if mishandled. Do not recharge, disassemble, heat above 100 °C (212 °F) or incinerate the battery.
- Replace the battery with a CR2025 made by Panasonic, Hitachi Maxell, Sony, Sanyo, or with Duracell2025. Use of other batteries may present a risk of fire or explosion.
- Dispose of the used battery according to applicable recycling regulations.

- Do not pick up the battery using tweezers or other metal tools as this will cause a short circuit.
- Wipe the battery with a clean dry cloth to ensure proper contact.
- Keep the battery out of the reach of children. If swallowed, seek medical assistance immediately. The battery case may break and the battery fluids may cause internal damage.
- Do not disassemble, heat or immerse the battery in water to avoid the risk of explosion.

● **For California, USA only:** The lithium battery included contains Perchlorate Material – special handling may apply. See www.dtsc.ca.gov/hazardouswaste/perchlorate for details.

Built-in Rechargeable Lithium Battery

The camcorder has a built-in rechargeable lithium battery to keep the date/time and other settings. The built-in lithium battery is recharged while you use the camcorder, however, it will become totally discharged if you do not use the camcorder for about 3 months.

To recharge the built-in lithium battery:

Connect the compact power adapter to the camcorder and leave it connected for 24 hours with the **POWER** switch set to **OFF**.

Maintenance/Others

Cleaning the Video Heads

- In the following cases the video heads are dirty and need to be cleaned.
 - The message "HEADS DIRTY, USE CLEANING CASSETTE" appears.
 - During playback you notice frequent video problems (blocky video artifacts, banding, etc.).
 - When playing back a tape recorded in HDV standard the playback is jerky or the sound stutters on and off.

To maintain the best picture quality, we recommend using cassettes designed for high definition recording (Canon Digital Videocassette HDVM-E63PR, etc.) and cleaning the video heads frequently with the Canon DVM-CL Digital Video Head Cleaning Cassette or a commercially available dry cleaning cassette.

- Do not use wet type cleaning cassettes as this may damage the camcorder.
- Even after cleaning the video heads you may not be able to play back correctly tapes that were recorded with dirty video heads.

Cleaning the Camcorder

Camcorder Body

- Use a soft, dry cloth to clean the camcorder body. Never use chemically treated cloth or volatile solvents such as paint thinner.

Lens and Viewfinder

- If the lens surface is dirty, the autofocus may not work properly.
- Remove any dust or dirt particles using a non-aerosol type blower brush.

- Use a clean, soft lens-cleaning cloth to gently wipe the lens or viewfinder. Never use tissue paper.

LCD Screen and I.AF sensor

- Clean the LCD screen and the I.AF sensor using a clean, soft lens-cleaning cloth.
- Condensation may form on the surface of the screen when the temperature changes suddenly. Wipe it with a soft dry cloth.

Storage

- If you do not intend to use the camcorder for a long time, store it in a place free of dust, in low humidity, and at temperatures not higher than 30 °C (86 °F).

Condensation

Moving the camcorder rapidly between hot and cold temperatures may cause condensation (water droplets) to form on its internal surfaces. Stop using the camcorder if condensation is detected. Continued use may damage the camcorder.

Condensation may form in the following cases:

When the camcorder is moved from an air-conditioned room to a warm, humid place

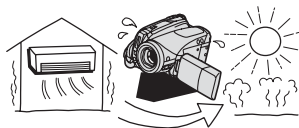

When the camcorder is moved from a cold place to a warm room

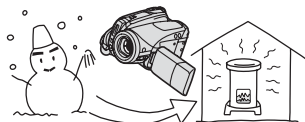

When the camcorder is left in a humid room

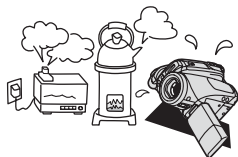

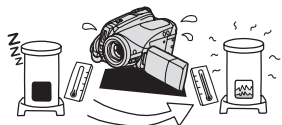

When a cold room is heated rapidly



TO AVOID CONDENSATION

- Do not expose the camcorder to sudden or extreme changes in temperature.
- Remove the cassette, place the camcorder in an airtight plastic bag and let it adjust to temperature changes slowly before removing it from the bag.

WHEN CONDENSATION IS DETECTED

- The camcorder automatically shuts off, the warning message "CONDENSATION HAS BEEN DETECTED" appears for approx. 4 seconds and  starts flashing.
- If a cassette is loaded, the warning message "REMOVE THE CASSETTE" appears and  starts flashing. Remove the cassette immediately and leave the cassette compartment open. Leaving the cassette in the camcorder may damage the tape.
- A cassette cannot be loaded when condensation is detected.

RESUMING USE

- The precise time required for water droplets to evaporate will vary depending on the location and weather conditions. After the condensation warning stops flashing, wait for 1 more hour before resuming use.

Using the Camcorder Abroad

Power Sources

You can use the compact power adapter to operate the camcorder and to charge battery packs in any country with power supply between 100 and 240 V AC, 50/60 Hz. Consult the Canon Service Center for information on plug adapters for overseas use.

Playback on a TV Screen

You can only play back your recordings on TVs compatible with the NTSC system. The NTSC system is used in the following countries/areas:

American Samoa, Antigua, Aruba, Bahamas, Barbados, Bermuda, Bolivia, Canada, Chile, Colombia, Costa Rica, Cuba, Ecuador, El Salvador, Guam, Guatemala, Greenland, Haiti, Honduras, Jamaica, Japan, Korea, Mexico, Micronesia, Myanmar, Nicaragua, Panama, Peru, Philippines, Puerto Rico, Saint Kitts and Nevis, Saint Lucia, Saint Vincent and the Grenadines, Surinam, Taiwan, Trinidad and Tobago, USA, Venezuela, Virgin Islands.

System Diagram (Availability differs from area to area)

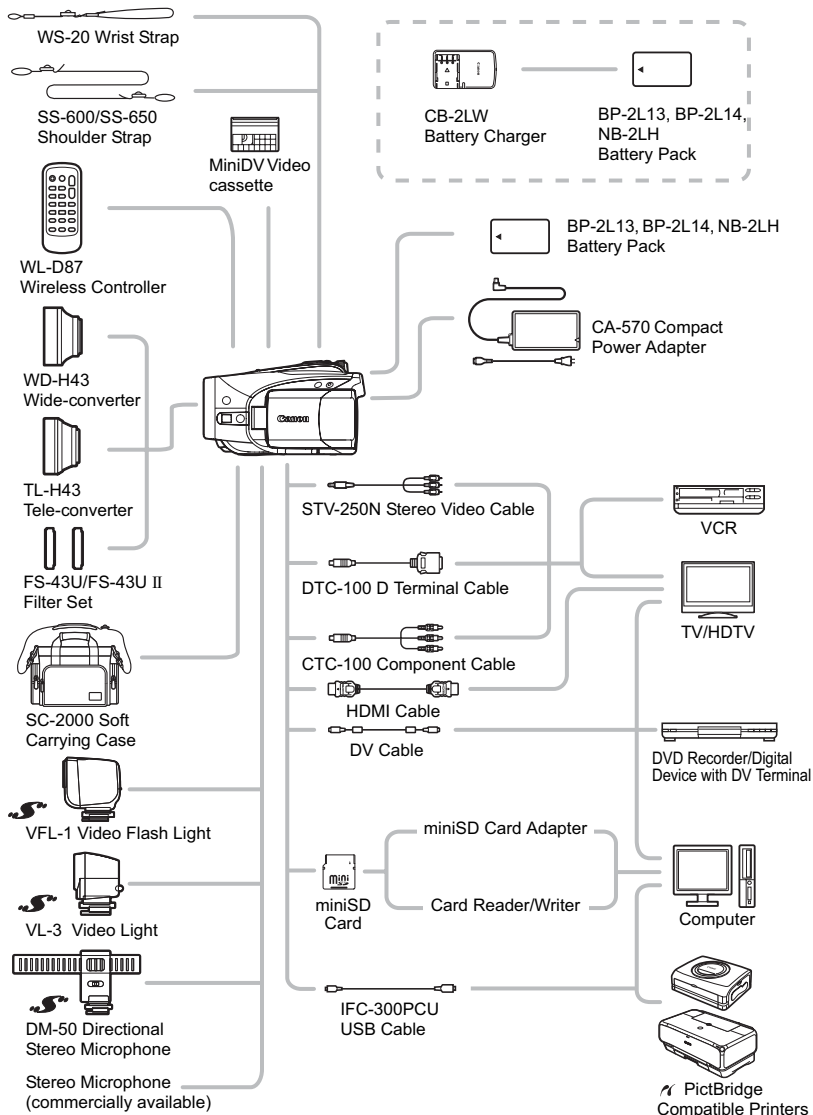

Optional Accessories

Call or visit your local retailer/dealer for genuine Canon video accessories. You can also obtain genuine accessories for your Canon camcorder by calling: 1-800-828-4040, Canon U.S.A. Information Center.

Use of genuine Canon accessories is recommended.

This product is designed to achieve excellent performance when used with genuine Canon accessories. Canon shall not be liable for any damage to this product and/or accidents such as fire, etc., caused by the malfunction of non-genuine Canon accessories (e.g., a leakage and/or explosion of a battery pack). Please note that this warranty does not apply to repairs arising out of the malfunction of non-genuine Canon accessories, although you may request such repairs on a chargeable basis.

Battery Packs

When you need extra battery packs, select one of the following models: BP-2L13, BP-2L14, NB-2LH.

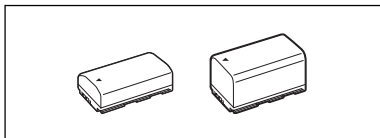

CB-2LW Battery Charger

Use the battery charger for charging the battery packs. It plugs directly into a power outlet without a cable.

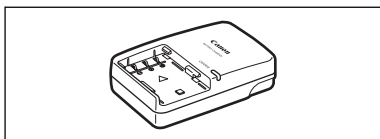

Battery Pack	Charging Time*
NB-2LH	90 min.
BP-2L13	175 min.
BP-2L14	170 min.

* Charging time varies according to the charging condition.

TL-H43 Tele-converter

This Tele-converter lens increases the focal length of the camcorder lens by a factor of 1.7.

- The image stabilizer is not as effective when the Tele-converter is attached.
- The minimum focusing distance with the TL-H43 is 3 m (9.8 ft.); 3 cm (1.2 in.) at maximum wide angle.
- When the Tele-converter is attached, a shadow may appear in the picture when you record with flash or assist lamp.

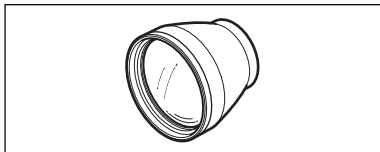

WD-H43 Wide-converter

This lens decreases focal length by a factor of 0.7, giving you a wide perspective for indoor shots or panoramic views.

- When the Wide-converter is attached, a shadow may appear in the picture when you record with flash or assist lamp.

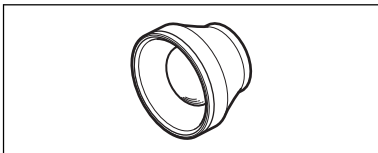
**FS-43U/FS-43U II Filter Set**

Neutral density and MC protector filters help you to control difficult lighting conditions.

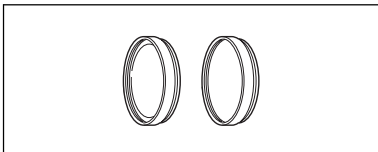
**VFL-1 Video Flash Light**

This video flash light allows you to record still images and movies even at night or in dark places. It attaches to the camcorder's advanced accessory shoe for cable-free operation.

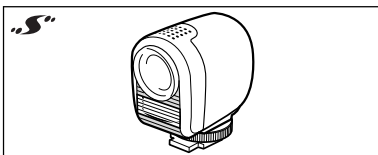
**VL-3 Video Light**

This video light enables you to record brightly in color even in dark places. It attaches to the camcorder's advanced accessory shoe for cable-free operation.

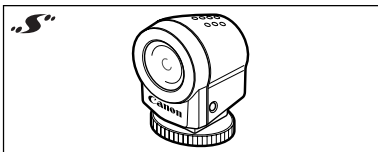
**DM-50 Directional Stereo Microphone**

This highly sensitive, super-directional microphone attaches to the camcorder's advanced accessory shoe. It can be used as directional microphone (monaural) or stereo microphone.

- Using the viewfinder to record video when the DM-50 is attached may prevent you from enjoying the full capabilities of the camcorder (for example, you may accidentally touch the microphone and include noise in the recording). Please use the LCD screen and keep a distance from the microphone.

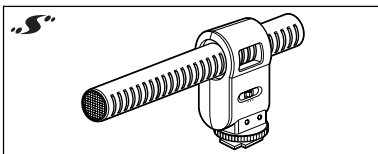

Shoulder Strap

You can attach a shoulder strap for more security and portability. Pass the ends through the strap mount and adjust the length of the strap.

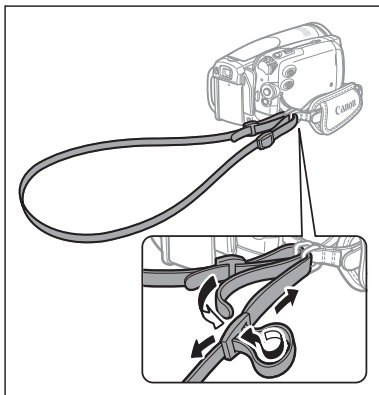
**WS-20 Wrist Strap**

Use this for extra additional protection for active shooting.

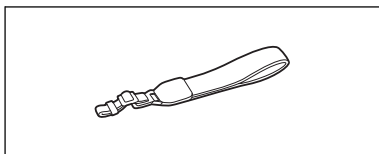
**SC-2000 Soft Carrying Case**

A handy camcorder bag with padded compartments and plenty of space for accessories.



This mark identifies genuine Canon video accessories. When you use Canon video equipment, we recommend Canon-brand accessories or products bearing the same mark.



Product Codes**Provided Accessories**

CA-570 Compact Power Adapter	8468A002AA
BP-2L13 Battery Pack	2069B002AA (D85-1712-000)
WL-D87 Wireless Controller	D83-0752-000
STV-250N Stereo Video Cable	3067A002AA (D82-0590-201)
CTC-100 Component Cable	1719B001AA

Optional Accessories

NB-2LH Battery Pack	9612A001AA
BP-2L14 Battery Pack	9582A002AA
CB-2LW Battery Charger	0763B001AA
TL-H43 Tele-converter	2071B001AA
WD-H43 Wide-converter	2072B001AA
FS-43U/FS-43U II Filter Set	7150A001AA
VFL-1 Video Flash Light	8834A001AA
VL-3 Video Light	3175A002AA
DM-50 Directional Stereo Microphone	3176A002AA
WS-20 Wrist Strap	1729B001AA
SC-2000 Soft Carrying Case	9389A001AA
DVM-CL Digital Video Head Cleaning Cassette	3134A002AA
HDVM-E63PR Digital Video Cassette	1313B001AA

Specifications

HV20

System

Video Recording System	2 rotary heads, helical scanning [HDV] HDV 1080i ¹ [DV] DV system (consumer digital VCR SD system), digital component recording
Audio Recording System	[HDV] MPEG-1 Audio Layer 2, 16 bit, 48 kHz; transfer rate 384 kbps (2 channels) [DV] PCM digital sound: 16 bit (48 kHz/2 channels); 12 bit (32 kHz/4 channels)
Television System	[HD] High Definition Video (HDV) 1080/60i [SD] EIA standard (525 lines, 60 fields) NTSC color signal
Compatible Tapes	Videocassettes bearing the [™] [IX] mark
Tape Speed	[HDV] 18.81 mm/s (0.74 ips) [DV] SP: 18.81 mm/s (0.74 ips); LP: 12.56 mm/s (0.49 ips)
Maximum Recording Time (60 min. tape)	[HDV] 60 minutes [DV] SP: 60 minutes; LP: 90 minutes
Image Sensor	1/2.7-inch CMOS, approx. 2,960,000 pixels Effective pixels: Movies (16:9): approx. 2,070,000 Movies (4:3): approx. 1,550,000 Still images (LW): approx. 2,070,000 Still images (L, M, S): approx. 2,760,000
LCD Screen	2.7 in., wide, TFT color, approx. 211,000 pixels
Viewfinder	0.27 in., wide, TFT color, approx. 123,000 pixels
Microphone	Stereo electret condenser microphone
Lens	f=6.1-61 mm, F/1.8-3.0, 10x power zoom 35 mm equivalent: Movies (16:9): 43.6-436 mm Movies (4:3): 53.0-530 mm Still images (LW): 43.6-436 mm Still images (L, M, S): 40.0-400 mm
Lens Configuration	11 elements in 9 groups
Filter Diameter	43 mm
AF system	Autofocus (TTL + external distance sensor when set to [INSTANT AF]), manual focus available
Minimum Focusing Distance	1 m (3.3 ft.); 1 cm (0.39 in.) on maximum wide angle
White Balance	Auto white balance, preset white balance (DAYLIGHT, SHADE, CLOUDY, TUNGSTEN, FLUORESCENT, FLUORESCENT H) or custom white balance
Minimum Illumination	0.2 lx ([NIGHT] recording program, Shutter speed at 1/2) 3 lx (Auto mode, Auto slow shutter [ON], Shutter speed at 1/30)
Recommended Illumination	More than 100 lx
Image Stabilization	Optical

¹ You can play back with this camcorder tapes recorded in HDV standard with a Canon XL H1, XH G1 or XH A1 (including 24F or 30F mode).

Video shot with the **[HDV]** HDV (PF24) standard will be recorded on the tape as 60i.

Memory Card

Recording Media	miniSD Card ²
Size of Still Images	2048 x 1536, 1920 x 1080, 1440 x 1080, 848 x 480, 640 x 480 pixels

File Format	Design rule for Camera File system (DCF), Exif 2.2 ³ compliant, DPOF compliant
--------------------	---

Image Compression Method	JPEG (compression: Super Fine, Fine, Normal)
---------------------------------	--

² This camcorder has been tested with miniSD cards up to 2 GB. Performance cannot be guaranteed for all miniSD cards.

³ This camcorder supports Exif 2.2 (also called "Exif Print"). Exif Print is a standard for enhancing the communication between camcorders and printers. By connecting to an Exif Print-compliant printer, the camcorder's image data at the time of shooting is used and optimized, yielding extremely high quality prints.

Input/Output Terminals

AV/⌚ Terminal	<p>∅ 3.5 mm minijack (dual purpose terminal also for headphones stereo output)</p> <p>Video: 1 Vp-p/75 ohms unbalanced</p> <p>Audio: output: -10 dBV (47 kohms load/3 kohms or less)</p> <p>input: -10 dBV/40 kohms or more</p>
USB Terminal	mini-B
HDV/DV Terminal	4 pin (IEEE1394 standard), input/output
COMPONENT OUT Terminal	<p>Luminance (Y): 1 Vp-p/75 ohms</p> <p>Chrominance (P_B/P_R (C_B/C_R)): ±350 mVp-p</p> <p>1080i (D3) / 480i (D1) compatible</p>
HDMI Terminal	HDMI type A connector (19 pins), output only
MIC Terminal	<p>∅ 3.5 mm stereo minijack</p> <p>-57 dBV (with 600 ohm microphone)/5 kohms or more</p>

Power/Others

Power supply (rated)	7.4 V DC (battery pack), 8.4 V DC (compact power adapter)
Power consumption (HDV, AF on)	4.3 W (viewfinder), 4.5 W (LCD screen, normal brightness)
Operating temperature	0 – 40 °C (32 – 104 °F)
Dimensions (W x H x D)	88 x 80 x 138 mm (3.5 x 3.2 x 5.4 in.) excluding the grip belt
Weight (camcorder body only)	535 g (1.2 lb.)

CA-570 Compact Power Adapter

Power supply	100 – 240 V AC, 50/60 Hz
Power consumption	17 W
Rated output	8.4 V DC, 1.5 A
Operating temperature	0 – 40 °C (32 – 104 °F)
Dimensions	52 x 90 x 29 mm (2.1 x 3.5 x 1.1 in.)
Weight	135 g (4.8 oz.)

BP-2L13 Battery Pack

Battery type	Rechargeable Lithium Ion Battery
Rated voltage	7.4 V DC
Operating temperature	0 – 40 °C (32 – 104 °F)
Battery capacity	1,200 mAh
Dimensions	33.3 x 25.8 x 45.2 mm (1.3 x 1.0 x 1.8 in.)
Weight	60 g (2.1 oz.)

Weight and dimensions are approximate. Errors and omissions excepted. Subject to change without notice.

Index

16:9 aspect ratio	38
24p Cinema Mode	
(24 fps progressive)	38, 46
6-second auto date	43
9 Point AiAF (Autofocus)	55

A

Abroad, using the camcorder	95
AEB - Auto exposure bracketing	56
AF-assist lamp	59
Analog video input	71
Analog/digital (A/D) converter	73
Aperture (f number)	46
Assist functions	43, 50
Audio output channel	41
Audio recording level	60
Auto (recording program)	45
Auto slow shutter	37
Autofocus (AF)	55
Av (recording program)	46
AV/Ⓜ terminal	66

B

Backlight correction	48
Battery pack, charging	18
Battery pack, remaining charge	16
Beach (recording program)	45
Beep	44
Built-in backup battery	93

C

Center point (Autofocus)	55
Cine Mode (recording program)	45
Compact power adapter	18
COMPONENT OUT terminal	66
Component video	41, 67
Condensation	94
Connection to a computer	75
Connection to a High Definition TV	
(HDTV)	67
Connection to a TV/VCR	66
Continuous shooting	56

D

Data code	57
Date and time	25
Date search	32
Daylight saving time	24
Digital effects	62
Digital video input (DV dubbing)	72
Digital zoom	37
Direct print	79
Direct transfer	77
Drive mode	56
DV audio mode	39
DV recording mode	39

E

End Search	32
Erasing still images	64
Error messages	88

F

File numbers	40
Fireworks (recording program)	45
Flash	58
Focus priority	38
FUNC. menu	23, 35

G

Grip belt	21
-----------	----

H

HDMI OUT terminal	66, 69
HDV/DV terminal	66, 75
Headphones	30
High-speed continuous shooting	56

I

Image effects	51
Image jump	33
Image stabilizer	38
Index screen	34
Initialization - Memory card	65

J

Joystick	10
Joystick guide	10

L

Language	24
LCD backlight	22
LCD screen	22
Light metering mode	54
Lithium button battery	21, 93
LP mode	39

M

Magnifying the playback image	34
Maintenance	94
Manual exposure adjustment	48
Manual focus	49
Memory card	20, 92
Microphone	61
Microphone attenuator	60
Mini video light	59
miniSD card	20
Mix balance	41
Mode switch	45

N

Night (recording program)	45
Normal TV (4:3)	40

P

P (recording program)	46
Playback - Movies	29
Playback - Still images	33
Playback standard	40
Portrait (recording program)	45
Power save	44
Print order	82
Print/share button	77, 80
Printing still images	79
Protecting still images	64

R

Recording - Movies	26
Recording - Still images	27
Recording data	57
Recording programs	45
Recording reminder	16
Remaining tape indicator	16
Remote sensor	21
RESET	84

Reviewing - Movies (Record review)	26
Reviewing - Still images	39

S

Screen displays	15
Screen markers	43
Selecting the on-screen displays	57
Self timer	60
Serial number	12
Setup menus	23, 37
Shoulder strap	99
Shutter speed	46
Simultaneous recording (tape/memory card)	53
Slideshow	34
Snow (recording program)	45
SP mode	39
Special Scene (recording programs)	47
Sports (recording program)	45
Spot AE frame	54
Spotlight (recording program)	45
Still image quality	52
Still image size	52
Sunset (recording program)	45

T

Tape recording standards - HDV/DV	38
Telephoto	28
Time zone	24
Transfer order	78
Transferring still images	77
Tripod	27
Troubleshooting	84
Tv (recording program)	46

U

USB terminal	75
--------------	----

V

Video heads, cleaning	94
Videocassettes	20, 92
Viewfinder, dioptic adjustment	21
Volume	30

W

White balance	50
Wide angle	28
Wide TV (16:9)	40
Wind screen	39
Wireless controller	21

Z

Zero set memory	31
Zoom	28
Zoom speed	37

U.S.A.**CANON CONSUMER DIGITAL VIDEO EQUIPMENT LIMITED WARRANTY FOR THE UNITED STATES**

The warranty set forward below is given by Canon U.S.A., Inc. with respect to equipment purchased in the United States. The limited warranty is only effective upon presentation of your Bill of Sale or other proof of purchase. Canon consumer digital video equipment is warranted under normal, non-commercial, personal use, against defective materials or workmanship as follows:

Parts: Defective parts will be exchanged for new parts or comparable rebuilt parts for a period of ONE YEAR from the date of original purchase, except for a defective Video Head, which will be exchanged for a period of three months from the date of purchase.

Labor: For a period of ONE YEAR from the date of original purchase, labor will be provided free of charge by our factory service centers or designated service facilities located in the United States.

When returning equipment under this warranty, you must pre-pay the shipping charges, and you must enclose the Bill of Sale or other proof of purchase with a complete explanation of the problem. During your ONE-YEAR warranty period, repairs will be made and the equipment return-shipped to you free of charge. After your warranty period is over, you will be given an estimate of the cost of repair and an opportunity to approve or disapprove of the repair expense before it is incurred. If you approve, repairs will be made and the equipment return-shipped to you. (shipping charges apply). If you disapprove, we will return-ship the equipment at no charge to you.

Non-Canon brand peripheral equipment and software which may be distributed with Canon DV camcorders are sold "AS IS" without warranty of any kind by CUSA, including any implied warranty regarding merchantability or fitness for a particular purpose. The sole warranty with respect to such non-Canon brand items is given by the manufacturer or producer thereof.

CUSA shall have no responsibility under this limited warranty for use of Canon DV Camcorders in conjunction with incompatible peripheral equipment and incompatible software.

In order to obtain warranty service, contact the authorized Canon retail dealer from whom you purchased the DV Camcorder or call the CANON INFORMATION CENTER AT 1-800-828-4040). You will be directed to the nearest service facility for your product.

This Limited Warranty covers all defects encountered in normal use of the equipment and does not apply in the following cases:

- A) Loss or damage to the equipment due to abuse, mishandling, accident, improper maintenance, or failure to follow operating instructions;
- B) If the equipment is defective as a result of leaking batteries, sand, dirt or water damage;
- C) If defects or damages are caused by the use of unauthorized parts or by service other than our authorized agent;
- D) If the equipment is used for commercial or industrial use.

This Limited Warranty does not cover cabinet (exterior finish), video cassette tape, head cleanings, nor does it apply to equipment purchased outside the United States. This warranty does not cover units sold to rental firms, military operations, hotels, schools, hospitals or for other commercial, industrial, or institutional applications. These uses are covered only by such specific warranty as Canon may issue with such sales.

This Limited Warranty does not apply to accessories or consumables for the DV Camcorder, which are sold "AS IS", without warranty of any kind by CUSA.

Please retain this warranty card and your Bill of Sale as a permanent record of your purchase. This card is most important in order to be sure you are contacted right away should there be a safety inspection, modification or product recall under applicable laws or regulations.

NO IMPLIED WARRANTY, INCLUDING MERCHANTABILITY AND FITNESS FOR A PARTICULAR PURPOSE APPLIES TO THIS EQUIPMENT AFTER THE APPLICABLE PERIOD OF EXPRESS WARRANTY OR GUARANTY, EXCEPT AS MENTIONED ABOVE, GIVEN BY ANY PERSON, FIRM OR CORPORATION WITH RESPECT TO THIS EQUIPMENT SHALL BIND THE UNDERSIGNED. (SOME STATES DO NOT ALLOW LIMITATIONS ON HOW LONG AN IMPLIED WARRANTY LASTS, SO THE ABOVE LIMITATION OR EXCLUSION MAY NOT APPLY TO YOU). CUSA SHALL NOT BE LIABLE FOR LOSS OF REVENUES OR PROFITS, EXPENSE FOR SUBSTITUTE EQUIPMENT OR SERVICE, STORAGE CHARGES, LOSS OF DATA, OR ANY OTHER SPECIAL, INCIDENTAL OR CONSEQUENTIAL DAMAGES CAUSED BY THE USE, MISUSE OR INABILITY TO USE THE DV CAMCORDER, REGARDLESS OF THE LEGAL THEORY ON WHICH THE CLAIM IS BASED, AND EVEN IF CUSA HAS BEEN ADVISED OF THE POSSIBILITY OF SUCH DAMAGES. NOR SHALL RECOVERY OF ANY KIND AGAINST CUSA BE GREATER THAN THE PURCHASE PRICE OF THE DV CAMCORDER SOLD BY CUSA AND CAUSING THE ALLEGED DAMAGE. WITHOUT LIMITING THE FOREGOING, YOU ASSUME ALL RISK AND LIABILITY FOR LOSS, DAMAGE OR INJURY TO YOU AND YOUR PROPERTY AND TO OTHERS AND THEIR PROPERTY ARISING OUT OF USE, MISUSE OR INABILITY TO USE THE DV CAMCORDER NOT CAUSED DIRECTLY BY THE NEGLIGENCE OF CUSA. (SOME STATES DO NOT ALLOW THE EXCLUSION OR LIMITATION OF INCIDENTAL OR CONSEQUENTIAL DAMAGES, SO THE ABOVE LIMITATION MAY NOT APPLY TO YOU). THIS WARRANTY SHALL NOT EXTEND TO ANYONE OTHER THAN THE ORIGINAL PURCHASER OF THIS EQUIPMENT OR THE PERSON FOR WHOM IT WAS PURCHASED AS A GIFT.

This warranty gives you specific legal rights, and you may also have other rights which vary from state to state. CANON U.S.A., INC.

CANADA**CANON CONSUMER DIGITAL VIDEO EQUIPMENT LIMITED WARRANTY**

The limited warranty set forth below is given by Canon Canada Inc. ("Canon Canada") with respect to Canon digital video equipment purchased in Canada. This limited warranty is only effective upon presentation of a bill of sale or other proof of purchase for this Canon digital video equipment to a Canon Service Facility when repairs are required.

Canon consumer video digital equipment is warranted under normal, non-commercial, personal use, against defective materials or workmanship as follows:

Parts: Defective parts will be exchanged for new parts or, at Canon Canada's option, comparable rebuilt parts for a period of one year from the date of original purchase, except Video Heads which will be exchanged for a period of 3 months from the date of purchase.

Labour: For a period of one year from the date of original purchase, labour will be provided free of charge by our Canon Service Facilities in Canada.

This limited warranty covers all defects except where:

(a) The loss or damage to the product results from:

- i) accident, natural disaster, mishandling, abuse, neglect, unauthorized product modification or failure to follow instructions contained in the instruction manual;
- ii) the use of accessories, attachments, products, supplies, parts or devices with this Canon product that do not conform to Canon specifications or that cause abnormally frequent service problems;
- iii) repairs or services performed by any party other than a Canon Service Facility;
- iv) defective batteries or any exposure to water, sand or dirt;
- v) shipping (claim must be presented to the shipper);

(b) Any serial number on the video equipment is altered or removed.

(c) The digital video equipment is used for commercial, professional or industrial purposes.

This limited warranty does not cover the cabinet (exterior finish) of the digital video equipment, video cassette tapes, head cleanings, nor does it apply to digital video equipment purchased outside Canada.

TO OBTAIN WARRANTY SERVICE

Ship your Canon digital video equipment in its original carton, box or equivalent, properly packed, fully insured with shipping charges prepaid, together with a copy of your bill of sale or other proof of purchase and a description of the problem to any of the Canon Service Facilities in Canada.

LIMITATIONS

Except as otherwise required by applicable legislation, this warranty is in lieu of all other warranties, conditions, guarantees or representations, express or implied, statutory or otherwise, relative to this Canon product, including implied warranties or conditions of merchantability or fitness for a particular purpose.

Canon Canada assumes no liability for special, consequential or incidental damages or loss that may arise, whether on account of negligence or otherwise, from the use, misuse or inability to use this Canon product (including loss of profit, revenue, video tapes or enjoyment) or from failure to conform to any express or implied warranties, conditions, guarantees or representations. Any recovery under this limited warranty shall not exceed the purchase price of the product. Canon Canada does not assume or authorize any other person to assume for Canon Canada any other liability with respect to this Canon product.

This warranty does not extend to any person other than the original purchaser of this Canon product or the person for whom it was purchased as a gift and states your exclusive remedy.

NOTICE TO CONSUMER

If you plan to take important videos or if the product has not been used for some time, please check all functions with the instruction book before using it.



CANON INC.

U.S.A.

CANON U.S.A., INC. NEW JERSEY OFFICE

100 Jamesburg Road, Jamesburg, NJ 08831 USA

CANON U.S.A., INC. CHICAGO OFFICE

100 Park Blvd., Itasca, IL 60143 USA

CANON U.S.A., INC. LOS ANGELES OFFICE

15955 Alton Parkway, Irvine, CA 92618 USA

CANON U.S.A., INC. HONOLULU OFFICE

210 Ward Avenue, Suite 200, Honolulu, HI 96814 USA

- **If you have any questions, call the Canon U.S.A. Information Center toll-free at 1-800-828-4040 (U.S.A. only).**

CANADA

CANON CANADA INC. NATIONAL HEADQUARTERS

6390 Dixie Road, Mississauga, Ontario L5T 1P7

CANON CANADA INC. CALGARY

2828, 16th Street, N.E. Calgary, Alberta T2E 7K7

CANON CANADA INC. MONTREAL

5990 Côte de Liesse, Quebec H4T 1V7

- **If you have any questions, call the Canon Canada Information Center toll-free at 1-800-828-4040 (CANADA only).**

- **Si vous avez des questions, veuillez téléphoner sans frais au Canada 1-800-828-4040 (CANADA seulement).**

MEXICO

CANON MEXICANA, S. DE R.L. DE C.V.

Periferico Sur No. 4124 Col. Ex-Rancho de Anzaldo C.P. 01900
México, D.F., México

CANON U.S.A., INC. NEW JERSEY OFFICE

100 Jamesburg Road, Jamesburg, NJ 08831 USA

CENTRO Y SURAMÉRICA

CANON LATIN AMERICA, INC.

703 Waterford Way Suite 400 Miami, FL 33126 USA

ASIA

CANON HONGKONG COMPANY LTD.

19/F, The Metropolis Tower, 10 Metropolis Drive, Hunghom, Kowloon,
Hong Kong



The information on this manual is verified as of 1 February 2007.
Les informations contenues dans ce manuel ont été vérifiées le 1er février 2007.
La información de este manual fue verificada el 1 de febrero de 2007.



Printed on 100% reused paper.
Document réalisé avec du papier recyclé à 100%.
El papel aquí utilizado es 100% reciclado.