

HITACHI

Inspire the Next

1

5™



UltraVision HDTV Monitors

1.5" UltraThin Liquid Crystal Display

Anthracite Pearl Crystal Frame

1920 x 1080p 120Hz PictureMaster™ VI with Reel 120™

(1) HDMI™ (V.1.3 with CEC) Input; (1) RGB D-sub15 Input with Audio

Operating Guide

Model Name
UT37V702
UT42V702

READ THE ENCLOSED INSTRUCTIONS CAREFULLY.
KEEP THIS OPERATING GUIDE FOR FUTURE REFERENCE.
Record the serial number of your monitor for future reference.
SERIAL NO. _____

This serial number is located on the back and right side of the monitor.

ANY QUESTION ABOUT THIS PRODUCT PLEASE CONTACT 800-Hitachi

HDTV
MONITOR

HDMI™
HIGH-DEFINITION MULTIMEDIA INTERFACE

CONTENTS

IMPORTANT SAFETY INSTRUCTIONS	02
INTRODUCTION	04
About This Manual.....	04
Trademark Credits.....	04
Software.....	04
Features.....	04
SAFETY PRECAUTIONS	05
Explanation of the Symbols	05
Cleaning and Maintenance.....	08
Main Unit Installation	09
Anti-tumble Measures.....	09
Child Safety Notice	10
Wall Mount Setup	11
Floor Stand Setup.....	12
QUICK START GUIDE	13
1. Supplied Accessories (including option)	13
2. Connection.....	13
3. Insert the Batteries into the Remote Control.....	14
4. Power On.....	14
5. Language Selection.....	14
COMPONENT NAMES	15
Main Unit.....	15
Remote Control.....	16
PREPARATION	17
Remote Control Battery Installation.....	17
Handling the Remote Control	17
Caution When Moving the Main Unit	17
CONNECTION	18
1. Connect Power Cord to the Rear Panel	18
2. Connect your Equipment to the Monitor	18
Connecting to Equipment Having	
HDMI or DVI Output Terminals	18
Connecting to Equipment Having	
Video Output Terminals.....	19
Connecting to a PC.....	20
3. Attach Cushion, Secure with Clamps and Fit	
Terminal Cover.....	20
4. Connect the Power Plug into the Wall Socket	21
BASIC OPERATION	22
Power On/Off	22
Volume Up/Down	23
Mute.....	23
Input Switching to HDMI and RGB	24
Input Signal Screen Display.....	24

SETUP OPERATION	25
How to Use the Remote to Control your	
External Devices	25
Remote Control Codes	29
How to Use the On-Screen Display (OSD) System... 31	
Select Language.....	31
Main Menu List	32
Watching Images from HDMI/Composite Input	33
Setting Picture Adjustment	33
Reducing Noise	35
Making the Moving Image Smooth.....	36
Advanced Setting	37
Viewing Images from a PC	38
Setting Picture Adjustment	38
Advanced Setting	39
FUNCTION	40
Aspect Switching	40
HDMI/Composite Signal Input.....	40
Display Aspect	40
Position Adjustment	41
RGB Signal Input.....	41
Display Aspect	41
Power Save Mode	42
When HDMI/Composite Input is Selected	42
When RGB Input is Selected.....	42
TROUBLESHOOTING	43
About LCD Display Technology	43
When the Following Messages Appear	
on the Screen	43
Symptom and Checklist	43
PRODUCT SPECIFICATIONS	46
Signal Input.....	47
Recommended Signal List.....	48
Dimensions	49
SERVICE INFORMATION	51
LIMITED WARRANTY	52
END USER LICENSE AGREEMENT	53

IMPORTANT SAFETY INSTRUCTIONS

SAFETY POINTS YOU SHOULD KNOW ABOUT YOUR HITACHI LCD MONITOR

Our reputation has been built on the quality, performance, and ease of service of Hitachi LCD Monitors.

Safety is also foremost in our minds in the design of these units. To help you operate these products properly, this section illustrates safety tips which will be of benefit to you. Please read it carefully and apply the knowledge you obtain from it to the proper operation of your Hitachi LCD Monitor.

Please fill out your warranty card and mail it to Hitachi. This will enable Hitachi to notify you promptly in the improbable event that a safety problem should be discovered in your product model. Model and serial numbers are indicated on back side and right side of the LCD Monitor.

	CAUTION RISK OF ELECTRIC SHOCK DO NOT OPEN	
CAUTION: TO REDUCE THE RISK OF ELECTRIC SHOCK, DO NOT REMOVE COVER (OR BACK). NO USER SERVICEABLE PARTS INSIDE. REFER SERVICING TO QUALIFIED SERVICE PERSONNEL.		



The lightning flash with arrowhead symbol, within an equilateral triangle, is intended to alert the user to the presence of uninsulated "dangerous voltage" within the product's enclosure that may be of a sufficient magnitude to constitute a risk of electric shock to a person.



The exclamation point within an equilateral triangle, is intended to alert the user to the presence of important operating and maintenance (servicing) instructions in the literature accompanying the appliance.

READ BEFORE OPERATING EQUIPMENT

Follow all warnings and instructions marked on this LCD Monitor.

1. Read these instructions.
2. Keep these instructions.
3. Heed all warnings.
4. Follow all instructions.
5. Do not use this apparatus near water.
6. Clean only with a dry cloth.
7. Do not block any ventilation openings. Install in accordance with the manufacturer's instructions.
8. Do not install near any heat sources such as radiators, heat registers, stoves, or other apparatus (including amplifiers) that produce heat.
9. Do not defeat the safety purpose of the polarized or grounding-type plug. A polarized plug has two blades with one wider than the other. A grounding type plug has two blades and a third grounding prong. The wide blade or the third prong are provided for your safety. If the provided plug does not fit into your outlet, consult an electrician for replacement of the obsolete outlet.
10. Protect the power cord from being walked on or pinched particularly at plugs, convenience receptacles, and the point where they exit from the apparatus.
11. Only use the attachments/accessories specified by the manufacturer.
12. Use only with the cart, stand, tripod, bracket, or table specified by the manufacturer, or sold with the apparatus. When a cart is used, use caution when moving the cart/apparatus combination to avoid injury from tip-over.
13. Unplug this apparatus during lightning storms or when unused for long periods of time.
14. Refer all servicing to qualified service personnel. Servicing is required when the apparatus has been damaged in any way, such as power-supply cord or plug is damaged, liquid has been spilled or objects have fallen into the apparatus, the apparatus has been exposed to rain or moisture, does not operate normally, or has been dropped.



15. Monitors and Televisions are designed to comply with the recommended safety standards for tilt and stability. Do not apply excessive pulling force to the front, or top, of the cabinet which could cause the product to overturn resulting in product damage and/or personal injury.
16. Follow instructions for wall, shelf or ceiling mounting as recommended by the manufacturer.
17. An outdoor antenna should not be located in the vicinity of overhead power lines or other electrical circuits.
18. If an outside antenna is connected to the receiver and the monitor be sure the antenna system is grounded so as to provide some protection against voltage surges and built up static charges. Section 810 of the National Electric Code, ANSI/NFPA No. 70-1984, provides information with respect to proper grounding for the mast and supporting structure, grounding of the lead-in wire to an antenna discharge unit, size of grounding connectors, location of antenna discharge unit, connection to grounding electrodes and requirements for the grounding electrode.

NOTE

To the CATV system installer: This reminder is provided to call the CATV system installer's attention to Article 820-44 of the NEC that provides guidelines for proper grounding and, in particular, specifies that the cable ground shall be connected to the grounding system of the building, as close to the point of cable entry as practical.

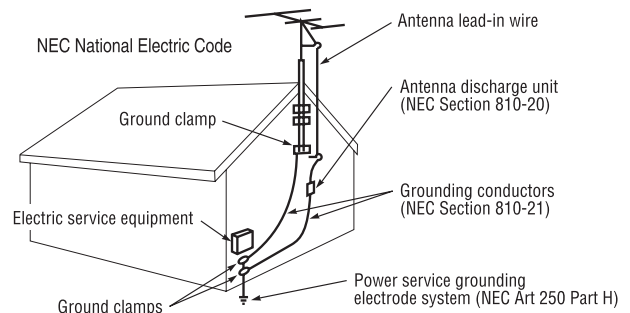

IMPORTANT SAFETY INSTRUCTIONS (continued)

Warning



- To reduce the risk of fire or electric shock, do not expose this apparatus to rain or moisture.
- The LCD Monitor should not be exposed to dripping or splashing and objects filled with liquids, such as vases, should not be placed on the Monitor.
- This apparatus shall be connected to a mains socket outlet with a protective earthing connection.
- The mains plug is used as the disconnect device and shall remain readily operable.

If problems occur during installation or operation of the product, before calling for technical support or service technicians, please read "TROUBLESHOOTING" (43 ~ 45) to determine the symptoms.

If serious problems occur (such as smoke or an abnormal odor from the unit), turn off the main power, unplug the power cord, and then, contact 800-HITACHI immediately.

Lead/Mercury Notice



This product contains lead and one or more non-replaceable mercury backlights. Do not put in trash. Recycle or dispose of according to applicable laws. For product recycling and disposal information, contact your local government agency or visit www.eiae.org (in USA) or www.epsc.ca (in Canada). **FOR MORE INFORMATION, CALL 800-HITACHI.**

FEDERAL COMMUNICATIONS COMMISSION NOTICE

This equipment has been tested and found to comply with the limits for a Class B digital device, pursuant to Part 15 of the FCC Rules. These limits are designed to provide reasonable protection against harmful interference in a residential installation. This equipment generates, uses and can radiate radio frequency energy and if not installed and used in accordance with the instructions, may cause harmful interference to radio communications. However, there is no guarantee that interference will not occur in a particular installation. If this equipment does cause harmful interference to radio or television reception, which can be determined by turning the equipment off and on, the user is encouraged to try to correct the interference by one or more of the following measures:

- If the Monitor is connected with a Set Top Box or TV Receiver, reorient or relocate the receiving antenna.
- Increase the separation between the equipment and the receiver.
- Connect the equipment into an outlet on a circuit different from that to which the receiver is connected.
- Consult the dealer or an experienced radio/television technician for help.

Declaration of Conformity

This device complies with part 15 of the FCC Rules. Operation is subject to the following two conditions :

(1) This device may not cause harmful interference and (2) This device must accept any interference received, including interference that may cause undesired operation.

For questions regarding this declaration, contact:

Hitachi Home Electronics (America), Inc.
900 Hitachi Way
Chula Vista, CA 91914-3556
Tel. 800-448-2244 (800-HITACHI)
ATTN: Customer Relations

Modifications

The FCC requires the user to be notified that any changes or modifications made to this device that are not expressly approved by Hitachi Home Electronics (America), Inc. may void the user's authority to operate the equipment.

Cables

Connections to this device must be made with shielded cables with metallic RF/EMI connector hoods to maintain compliance with FCC Rules and Regulations.

Any cables that are supplied with the system must be replaced with identical cables in order to assure compliance with FCC rules. Order Hitachi spares as replacement cables.

INDUSTRY CANADA AGENCY REGULATORY INFORMATION

This class B digital apparatus meets all requirements of the Canadian Interference-Causing Equipment Regulations.

This Class B digital apparatus complies with Canadian ICES-003.

Cet appareil numérique de la classe B est conforme à la norme NMB-003 du Canada.

INTRODUCTION

Thank you for purchasing the Hitachi 1.5 LCD Monitor. We hope that you will enjoy the outstanding performance of this product.

This LCD Monitor has been designed to comply with international standards. However, it could cause personal injury and property damage if improperly handled. In order to prevent potential danger and obtain maximum benefit from your set, please read this operating guide carefully before operating this product and observe the following instructions when installing, operating, and cleaning the product. To ensure proper operation, please read and follow ALL the instructions, especially the "IMPORTANT SAFETY INSTRUCTIONS" and "SAFETY PRECAUTIONS". Keep this manual for future reference and record the serial number of your set in the space provided on the front cover page of this manual.

About This Manual

- The information in this manual is subject to change without notice.
- This manual has been produced with the utmost care. If you have any comments or questions regarding this manual, please contact your local dealer or our Customer Service Center.
- Before operating the set, please fully understand the prerequisites such as specifications or constraints for the hardware and software. Hitachi is not responsible and accept no liability for any loss, damage or injury as a result of misuse.
- Reproduction, copying, utilization, modification and/or transmission in whole or in part of this manual are prohibited except by prior written consent.
- All other products and company names used in this manual are trademarks or registered trademarks of their respective owners.

Trademark Credits

- VGA and XGA are trademarks of International Business Machines Corporation.
- VESA is a registered trademark of the Video Electronics Standard Association.
- HDMI, the HDMI logo and High-Definition Multimedia Interface are trademarks or registered trademarks of HDMI Licensing LLC.

Even if no special note has been made of company or product trademarks, these trademarks have been fully respected.

Software

It is illegal for you to alter, decompile, disassemble, decrypt, or otherwise reverse-engineer the software installed in this product.

Features



- UltraVision 37" and 42" HDTV Monitors
- 1.5" UltraThin Liquid Crystal Display
- Wide Viewing Angle IPS (In-Plane Switching) Technology
- Picture Enhancement: Smooth Motion Film process
- High Resolution Progressive Display 1920(H) x 1080(V)
- High Efficiency EEFL (External Electrode Fluorescent Lamp) BackLight
- (1) HDMI™ (V.1.3 with CEC) Input
- (1) RGB D-sub15 Input with Audio
- Preprogrammed Remote Control
- Easy-to-use Multi-Language On-Screen Display
- High Quality Audio System with 4 Drivers
- High Efficiency Display with Power Saving Features



SAFETY PRECAUTIONS





For your safety, please read the following precautions carefully before using this product. Improper use would cause serious personal injury and/or damage to your property or the product.

Explanation of the Symbols

The following are the symbols used in this manual and affixed to the unit itself. Please fully understand the meanings of the symbols before reading the instructions in this section.

 WARNING	Never ignore the instruction. There are risks of serious or fatal injury to the user.
 CAUTION	Do not ignore the instruction. There are risks of personal injury and/or property damage.

Other Symbols	
	The triangle with illustration is intended to alert the users that there are risks of fire, explosion, or high temperature if the product is handled improperly. Each illustration within the triangle specifies the contents in detail. (The figure on the left is an example.)
	The circle with diagonal line and illustration indicates a prohibited action (the symbol to the left indicates that dismantling is prohibited).
	This symbol indicates a compulsory action. The contents are clearly indicated in or adjacent to an illustration (the symbol to the left indicates that the power plug should be disconnected from the power outlet).

 WARNING	
There is a risk of fire, electric shock, or serious injury.	
<p>■ If serious problems occur, unplug the power cord immediately.</p> <p>Serious problems such as:</p> <ul style="list-style-type: none"> • Smoke, abnormal odor or noise emitted from the product. • No picture, no sound or distorted picture on the display. • Foreign matter (such as water, metals etc.) entered the unit. <p>Do not continue using the product under these abnormal conditions. Turn off the main power, unplug the power cord, and contact 800-HITACHI immediately.</p> <p>For your safety, never try to repair the product yourself.</p>	 Disconnect the plug from the power outlet.
<p>■ Do not allow liquids or any foreign matter (such as metals or flammable items) to enter the unit.</p> <ul style="list-style-type: none"> • If this does occur, turn off the main power, unplug the power cord, and contact 800-HITACHI immediately. • Exercise special caution when young children are around the unit. 	
<p>■ Do not remove covers, or modify the product.</p> <ul style="list-style-type: none"> • High-voltage components are installed inside of the unit. Removing covers can expose you to high-voltage electric shock, and other hazardous conditions. • Contact 800-HITACHI to perform servicing such as inspection, adjustment or repair work. 	  Do not dismantle.

SAFETY PRECAUTIONS (continued)

WARNING

There is a risk of fire, electric shock or serious injury.

■ **Install the unit in a proper location where it does not expose anyone to danger.**

- If you bump against the edges of the unit, you could be injured.



■ **Do not rest weight on top of the unit.**

Objects such as

- Liquid containers (vase, fish tank, flowerpot, cosmetics or liquid medicine).
- If water or any liquid spills onto the unit, it may cause short-circuiting and result in fire or electric shock.
If this occurs, turn off the main power, unplug the power cord, and contact **800-HITACHI** immediately.
- Do not rest anything heavy on top of the unit.
- Do not climb on or hang from the unit.
- Do not allow your pets to get on top of the unit



■ **Do not install the unit in an unsuitable location.**

- This could cause a malfunction or in extreme cases danger of electric shock. Locations where high moisture is likely, such as bathrooms or shower rooms, close to windows, or outside where rain, snow or other inclement conditions could occur, should be avoided. Please also avoid installing the unit in a location where fumes from hot springs could come into contact with it.



■ **Unplug the unit in the event of a lightning storm.**

- To reduce the risk of electric shock, do not touch the product when lightning occurs.



Disconnect the plug from the power outlet.

■ **Do not do anything that may damage the power cord.**

- Do not damage, modify, twist, forcibly bend, heat, or pull excessively on the power cord.
- Do not place heavy objects (including the unit itself) on top of the power cord.
- If the power cord is damaged, contact **800-HITACHI** for repairs or exchange.



■ **Use only with designated power supply voltage.**

- To prevent the risk of fire and electric shock, operate the product only with the power supply voltage indicated on the unit.



■ **Be careful not to drop or allow any impact to affect the unit.**

- Take extra care while moving the unit.
- There is no protection glass on the surface of the LCD panel. Therefore do not press the panel surface with your fingers or hands. Also do not hit any objects against the monitor. These actions would damage the LCD cells or the panel surface and could cause failure or personal injury.
- In the event that you drop the unit or the cabinet is damaged, turn off the main power, unplug the power cord and contact **800-HITACHI** immediately.
- Continuing use of the product under the above conditions may cause fire or electric shock.



■ **Clean dust or metals from on or around the pins of the power plug regularly.**

- Continuing use of the product under the above conditions may cause fire or electric shock.
- Always unplug the power cord first, then clean the pins using a dry cloth.



■ **Do not place the unit on an unstable surface.**













Unstable surfaces such as:

- Tilted surface or shaky shelving, table, stand or trolley.
- If the unit falls down, this could cause personal injury.



SAFETY PRECAUTIONS (continued)

CAUTION

<ul style="list-style-type: none"> ■ Do not place or use the unit in a dusty location. <ul style="list-style-type: none"> • This could cause a malfunction. 	
<ul style="list-style-type: none"> ■ Do not cover or block any ventilation holes on the product. <ul style="list-style-type: none"> The unit would overheat and this could cause fire or damage to the product which may shorten its service lifetime. • Install the product in accordance with the instructions in this manual. • Do not place the unit with the ventilation side downward. • Do not install the unit on carpeting or bedding. • Do not cover the unit with table cloths etc. 	
<ul style="list-style-type: none"> ■ Be sure to ground the earth cable correctly. <ul style="list-style-type: none"> • Especially when you use a power cord adapter, be sure to connect the earth cable to the ground terminal. Incorrect connection could cause fire or electric shock. • For your safety, always make sure to unplug the power cord before connecting or disconnecting the earth cable. 	 Connect the earth cable.
<ul style="list-style-type: none"> ■ Observe the anti-tumble measures described in this manual. <ul style="list-style-type: none"> • If the unit tumbles over, there is a risk of personal, possibly fatal injury. Also, this would damage the product seriously. 	
<ul style="list-style-type: none"> ■ Do not install the unit near medical devices. <ul style="list-style-type: none"> • To prevent malfunction of medical devices, do not use the product and medical devices in the same room. 	
<ul style="list-style-type: none"> ■ Do not place a CRT-based television near the speakers of the LCD Monitor. <ul style="list-style-type: none"> • This could cause partial discoloration or blurring of the image on the CRT-based television. Please install it away from the speakers of the unit. 	
<ul style="list-style-type: none"> ■ Disconnect all of the external connection cables and detach the anti-tumble measures before moving the unit. <ul style="list-style-type: none"> • Otherwise fire, electric shock or personal injury may result. 	
<ul style="list-style-type: none"> ■ Connect the power plug securely. <ul style="list-style-type: none"> • Improper connection will cause overheating and may result in fire. • Do not touch the pins of the plug while connecting it to the wall socket. This could cause electric shock. • If the plug is not suitable for the wall socket, contact your dealer for replacement. 	 
<ul style="list-style-type: none"> ■ Do not handle the power cord with wet hands. <ul style="list-style-type: none"> • This could result in electric shock. 	
<ul style="list-style-type: none"> ■ Do not pull the cord when you unplug the power cord. <ul style="list-style-type: none"> • This may damage the cord and could result in fire or electric shock. • Grip the plug when disconnecting it. 	
<ul style="list-style-type: none"> ■ Unplug the power cord when you do not intend to use the product for long periods of time. 	
<ul style="list-style-type: none"> ■ Handle the batteries properly. <ul style="list-style-type: none"> • Improper or incorrect use of the batteries may cause corrosion or battery leakage, which could cause fire, personal injury or damage to property. • Use only the types of batteries which are indicated in this manual. • Do not replace batteries with used ones. • Install the batteries correctly by observing the polarity (+ and -) indications on the battery compartment. • Do not dispose of used batteries as domestic waste. Dispose of them in accordance with the local regulations. 	

SAFETY PRECAUTIONS (continued)

CAUTION

■ Do not install the unit in locations where it will be subjected to high temperature.

This could damage the cabinet or components of the product.

- Do not install near any heat sources such as radiators, heating grilles, stoves, or other apparatus that produce heat.
- Keep the unit out of direct sunlight. Otherwise the resulting increase in temperature of the unit may cause a malfunction.



■ Viewing Advice

- The lighting of the environment in which the product is used should be appropriate. Too bright/dark environments are not good for your eyes.
- Take time to relax your eyes occasionally.
- When you use the product, view from a distance equal to 3 to 7 times the height of the screen. This is the best viewing distance in order to protect your eyes against eyestrain. Example: (3X)= approx: 1.5m (4'), (7X)= approx: 3.5m (9').
- Adjust the volume to an appropriate level, especially during night time.

■ Transporting the product

- When the product needs to be transported due to moving or repair, use the carton box and buffer material that came with the product.
- Always transport the product upright; otherwise this could damage the LCD panel.
- Avoid laying the product down on its face or back.
- Avoid vibrations. If the product "must" be transported laying on its face, be sure to provide soft cushioning material.



■ Keep radios away from the unit while in use.

The unit is designed to meet the international EMI standards to prevent radio interference. However, the unit may generate noise in the radio.

- If noise is heard on the radio, please try the following actions.
 - Adjust the direction of the radio antenna in order not to receive interference from the unit.
 - Keep the radio away from the unit.



■ Infrared communication devices

- Infrared communication devices such as cordless microphones or cordless headphones may not operate properly around the unit. This is because of communication failure. Please note that this is not a malfunction.

■ When you dispose of the product at the end of its service lifetime, follow the regulations in your residential area.

- For more information, contact the local authority or the dealer where you purchased the product.

Cleaning and Maintenance

Please make sure to unplug the power cord before cleaning the unit.

■ How to clean the LCD panel of the unit.

- Wipe the panel with a lint-free and dry cloth in order to prevent damage to the panel surface.
- Do not use a chemical cloth or cleaners. Depending on the ingredients, these may cause discoloration and damage to the panel surface.
- Do not wipe with a rough cloth or rub hard. This may damage the panel surface.
- In case of greasy dirt such as fingerprints, wipe the panel surface with a lint-free cloth moistened with a diluted neutral detergent solution (dilute 1 part of detergent to 100 parts of water), and then wipe with a soft and dry cloth.
- Do not use a spray cleaner. This could cause a malfunction.

■ How to clean the cabinet of the unit.

- The following may cause cracking, deformation and peeling of paint.
 - Do not wipe the cabinet with benzene, thinners and other chemical products.
 - Do not spray volatile solutions such as insecticide over the cabinet.
 - Do not leave the cabinet in prolonged contact with plastic or rubber materials.
- Do not use a chemical cloth, cleaner or wax. Depending on the ingredients, these may cause cracking and deformation.
- Use a lint-free cloth (e.g. cloth for cleaning glasses) to clean the cabinet and control panel of the unit. In case of the excessive dirt, wipe with a soft cloth moistened with a diluted neutral detergent solution and then wipe with a soft and dry cloth.
- Never use the following detergents. They could cause cracking, discoloration and scratching.
 - Acidic/alkaline detergents, alcoholic detergents, abrasive cleaners, soap powder, OA cleaner, car wax, glass cleaner, etc.

SAFETY PRECAUTIONS (continued)

Main Unit Installation

When installing the main unit, be sure to use the specified mounting units in order to obtain maximum performance and maintain safety.

Hitachi assumes no responsibility nor liability for personal injuries or property damage caused by use of other mounting units or improper installation.

With respect to installation instructions, please read each user manual for the respective mounting units: for Tabletop Setup, Floor Stand Setup, Wall Mounting, and Ceiling Mounting.

If using Wall or Ceiling Mounting units, contact your local dealer and ask for an approved installation specialist to set up the unit. Never attempt to install it yourself. That could cause injury or damage.

Please leave adequate space around the unit in order to avoid increasing the internal temperature. Make sure not to block any ventilation holes. Do not install the unit in a small space such as inside a cabinet, closet or box without adequate ventilation. Leave at least 10cm (4") of clearance from each side of the unit and 30cm (1') from the top of the unit to ceiling.

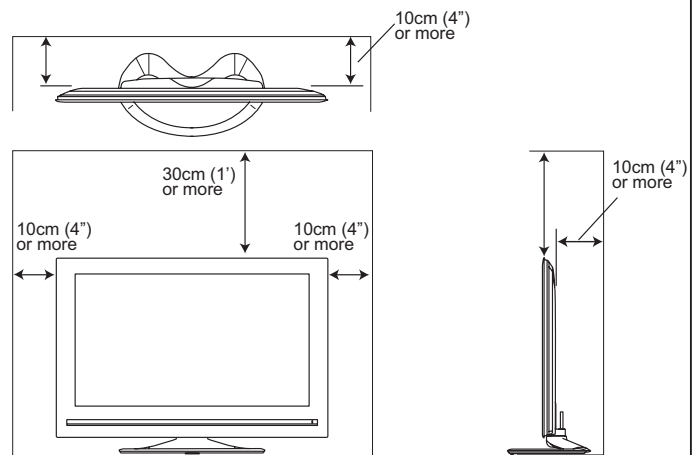

Anti-tumble Measures

Install in a stable location and take safety precautions against overturning.

Securing to a table

1 Remove the plastic rivet.

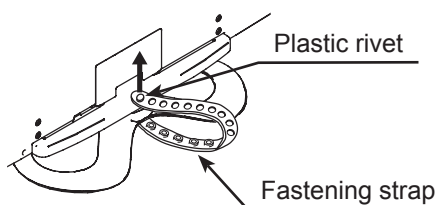

2 Fasten the fastening strap to a table using the wood screw provided.

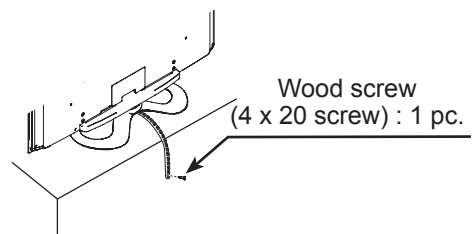

Securing to ceiling or wall

Use the specified mounting unit to secure the set to a ceiling. For Wall Mounting setup please refer to page (**11**). For Floor Stand setup please refer to page (**12**).

NOTE

- For more information regarding mounting of the unit, please contact **800-HITACHI**.
- Please install the unit in a proper location where it does not expose anyone to the danger of bumping themselves (for example their hands, head or face, etc) against the edges of the unit and causing personal injury.

SAFETY PRECAUTIONS (continued)

Child Safety Notice

CHILD SAFETY:

It Makes A Difference How and Where
You Use Your Flat Panel Display

Congratulations on your purchase! As you enjoy your new product, please keep these safety tips in mind:



THE ISSUE

- The home theater entertainment experience is a growing trend and larger flat displays are popular purchases. However, flat panel displays are not always supported on the proper stands or installed according to the manufacturer's recommendations.
- Flat Panel displays that are inappropriately situated on dresser, bookcases, shelves, desks, speakers, chest or carts may fall over and cause injury.

HITACHI CARES!

- The consumer electronics industry is committed to making home entertainment enjoyable and safe.

TUNE INTO SAFETY

- One size does NOT fit all. Follow the manufacturer's recommendations for the safe installation and use of your flat panel display.
- Carefully read and understand all enclosed instructions for proper use of this product.
- Don't allow children to climb on or play with furniture and television sets.
- Don't place flat panel displays on furniture that can easily be used as steps, such as a chest of drawers.
- Remember that children can become excited while watching a program, especially on a "larger than life" flat panel display. Care should be taken to place or install the display where it cannot be pushed, pulled over, or knocked down.
- Care should be taken to route all cords and cables connected to the flat panel display so that they cannot be pulled or grabbed by curious children.

WALL MOUNTING: IF YOU DECIDE TO WALL MOUNT YOUR FLAT PANEL DISPLAY, ALWAYS:

- Use a mount that has been recommended by the display manufacturer and/or listed by an independent laboratory (such as UL, CSA, ETL).
- Follow all instructions supplied by the display and wall mount manufacturers.
- If you have any doubts about your ability to safely install your flat panel display, contact your retailer about professional installation.
- Make sure that the wall where you are mounting the display is appropriate. Some wall mounts are not designed to be mounted to walls with steel studs or old cinder block construction. If you are unsure, contact a professional installer.
- A minimum of two people are required for installation. Flat panel displays can be heavy.



SAFETY PRECAUTIONS (continued)

Wall Mount Setup

1 Remove the Stand Base from the Monitor

About the Installation

This product is heavy and should be carried by at least 2 people.



WARNING

Please make sure screws are tightened properly. The torque should be 1.8~3.0 N.m (18~30 kgf.cm).



CAUTION

Keep the screws. They may be used for the Wall Mount installation.

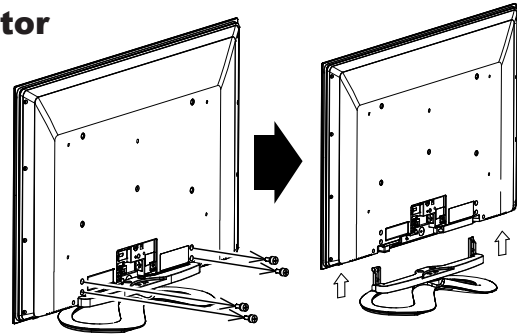

Remove the 4 screws and raise straight up from tabletop stand.

2 Install the Wall Mount Brackets on the Monitor using 4 screws (Screws Specification is shown below).

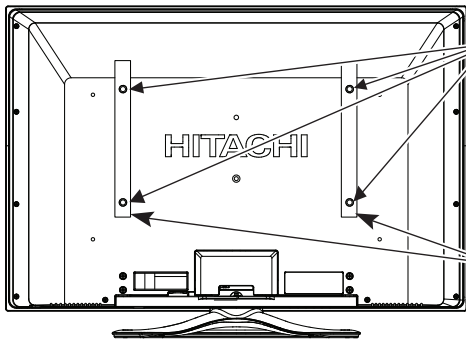

Screw Mounting Holes (4 places). Don't use the original flat head screws (A) that comes in the monitor, for the Wall Mount Bracket. The length is not long enough.

Wall Mount Brackets

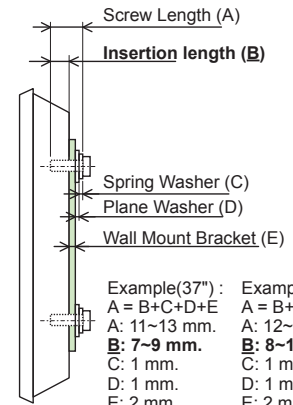

- For Wall Mount assembly; please refer to the Installation Manual of the Wall Mount Unit.
- If the Wall Mount Bracket thickness is 1~3 mm. the original screws removed from the stand base can be used for the Wall Mount installation.

• The screw type : Thread ISO M5 (Metric type, do not use Standard type).



CAUTION Insertion length (B) of the screws must be within 7~9 mm(37") or 8~12 mm(42"). If the length is less than 7 mm(37") or 8 mm(42"), the weight can not be maintained. If the length is more than 9 mm(37") or 12 mm(42"), a space is created between the Wall Mount Bracket and the Monitor. This length is **very important**.

3 Tips to consider for the location of the Monitor.

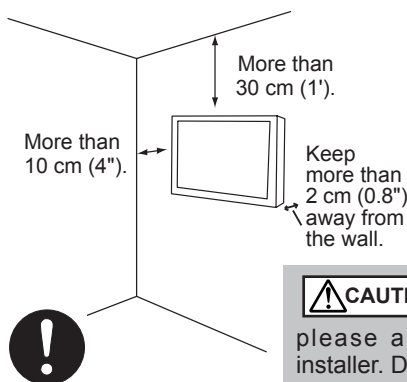

Do not block the ventilation holes. In addition please keep a certain distance around and make sure not to obstruct ventilation. Blocking the ventilation holes might cause fire or defect.



CAUTION If you purchased the Wall Mount unit, please ask for a professional installer. Do not install by yourself.

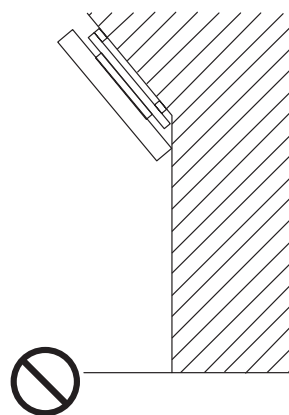

This ultrathin unit features an advanced ventilation system configured for vertical installation. A knowledgeable and experienced professional technician can perform other mounting or installation orientations (e.g., horizontal, tilted) provided that you specifically inform the technician of the unit's specialized ventilation needs. Call 800-HITACHI for additional info and guidance.



CAUTION Although this LCD Monitor can be installed using a variety of third party wall mounting brackets/devices, such third party brackets/devices have not been tested or approved by Hitachi for use or compatibility with this LCD Monitor. Accordingly, Hitachi accepts no responsibility or liability for any injuries or property damage resulting from the use of such third party brackets/devices. Hitachi strongly advises that any installation of this LCD Monitor using wall mounting brackets/devices be performed only by a qualified and experienced television installation technician who has completed a thorough evaluation of:

- a) the weight-bearing strength and stability of the intended wall mount surface; and
- b) the weight-bearing strength and compatibility of the intended wall mount brackets/device.

SAFETY PRECAUTIONS (continued)

Floor Stand Setup

1 Remove the Stand Base from the Monitor



Keep the screws. They will be used for the Floor stand installation.

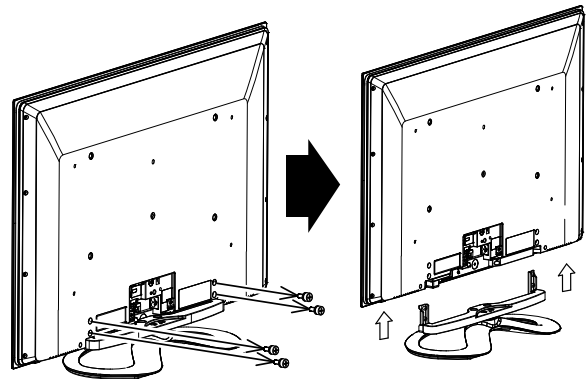

Remove the 4 screws and raise straight up from tabletop stand.

2 Install the Monitor on the Floor Stand

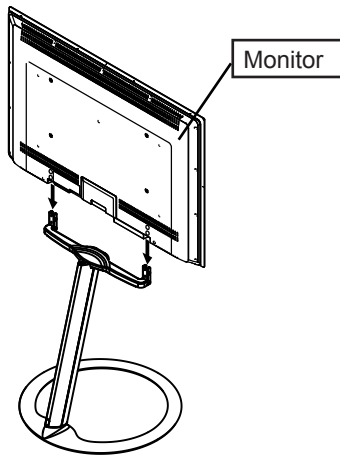

About the Installation

This product is heavy and should be carried by at least 2 people.

• For Stand Assembly; please refer to the Installation Manual of the Floor Stand.

3 Attach the Monitor to the Floor Stand with the 4 screws used with the tabletop stand.



Adjust Monitor position left or right to match with screw holes. If the screw holes do not align, the Monitor may be damaged.



Please make sure screws are tightened properly.

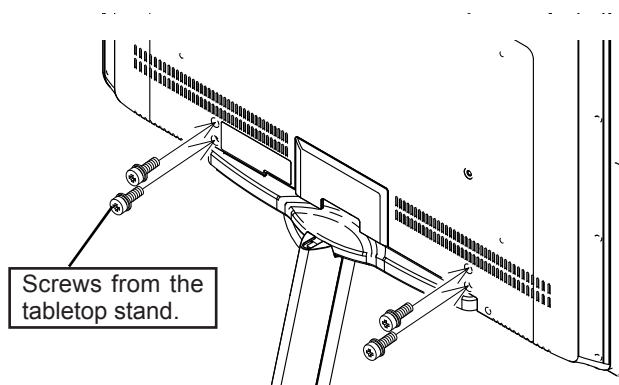

LCD Monitors are for use with Hitachi **AS-LSZ0081** or **AS-LSZ0082** Floor stand for UT37" Use with other floor stands could cause instability and possible injury.

QUICK START GUIDE

For more information on connecting and using your monitor, please be sure to read all instructions in this user manual.

1 Supplied Accessories (including option)

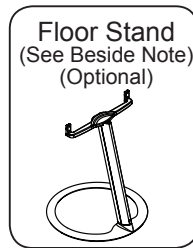
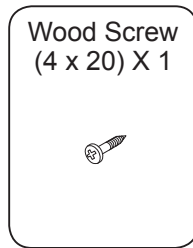
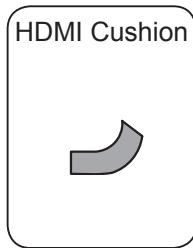
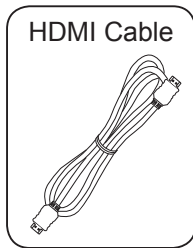
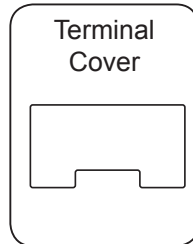
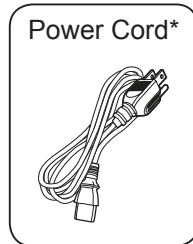
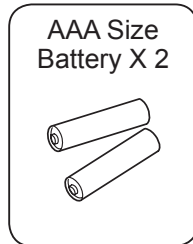
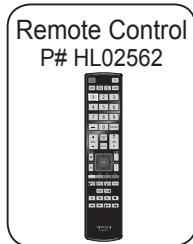
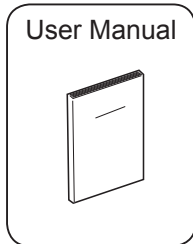

NOTE
Optional Floor Stand
AS-LSZ0081(37" black)
AS-LSZ0082(37" silver)

*For some countries, the type of power plug provided may be different from that depicted.

2 Connection 18~21

① Connect the power cord to the rear panel.

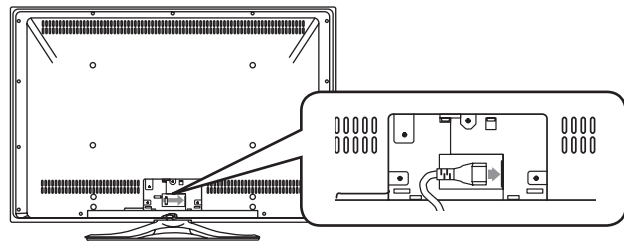

② Connect to external equipment.

Example 1: Connecting to PC

To insert D-sub 15 pin, tilt the monitor forward and bring the terminals into view. Two people are required to hold the monitor and insert D-sub 15 pin safely. Be careful not to damage the panel.

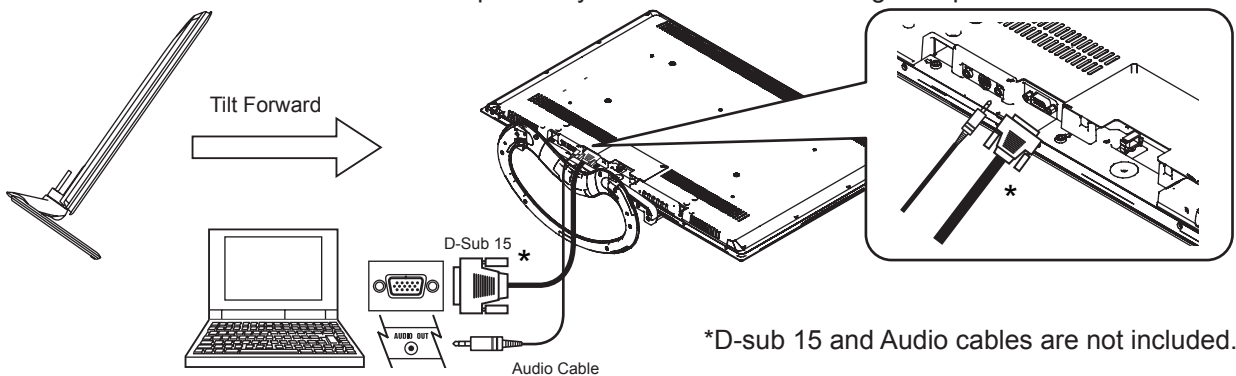

*D-sub 15 and Audio cables are not included.

Example 2: Connecting to DVD player

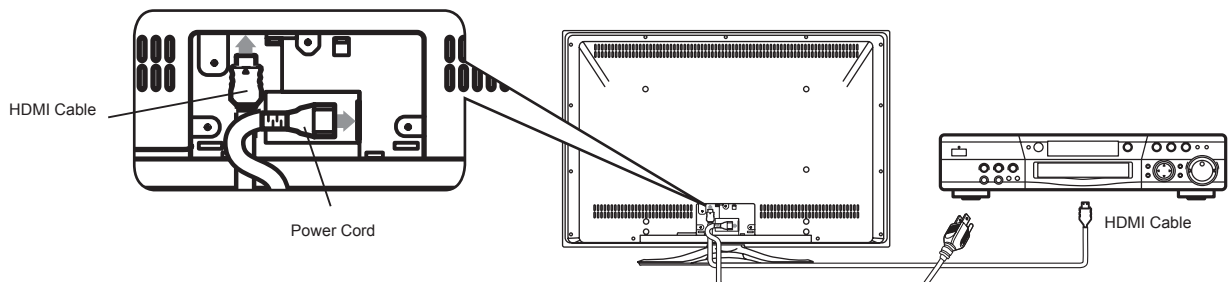

QUICK START GUIDE (continued)

3 Insert the Batteries into the Remote Control... 17

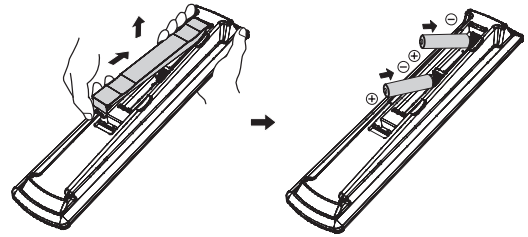

4 Power On... 22

- 1 Connect the plug into the wall socket after all other connections are completed.

CAUTION

- Ensure that both ends of the power cord are easily accessible.



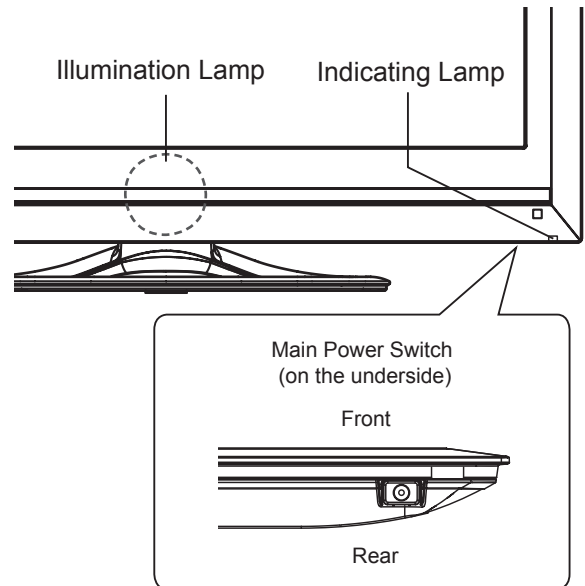
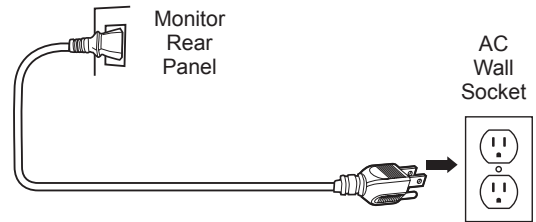

The Main Power Switch is factory set to On (activated), therefore after you connect the plug into the wall socket, the color of the indicating lamp must turn Green and the Illumination Lamp turns Blue. The image will display on screen.

Once the **Main Power** switch is on, you can turn On/Off by pressing the **Power (On/Off)** button on the remote control.



5 Language Selection

The initial language setting for on-screen displays is English (US). You can change to your preferred language.

- 1 Press the  button to display Main Menu.
- 2 Select **“Language”** using the  button.
- 3 Select the language you prefer from the list using the  button and then press the  button.

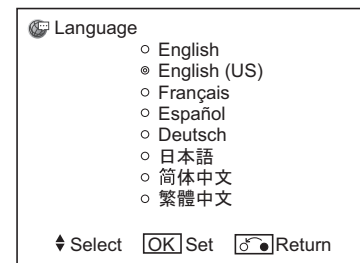

COMPONENT NAMES

Main Unit

Front Panel

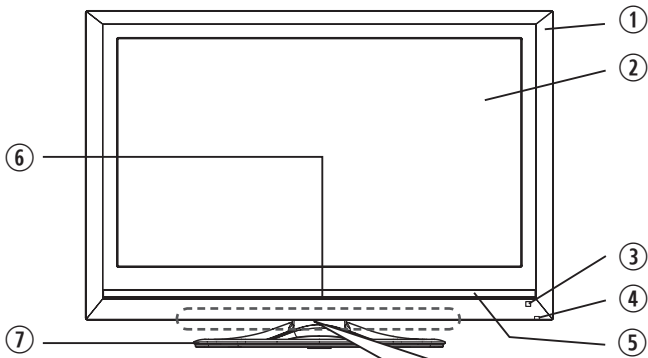

- ① Cabinet
- ② Panel
- ③ Remote Control Receiver
- ④ Indicating Lamp
- ⑤ Speaker
- ⑥ Illumination Lamp
- ⑦ Tabletop Stand

Control panel (located on the bottom)

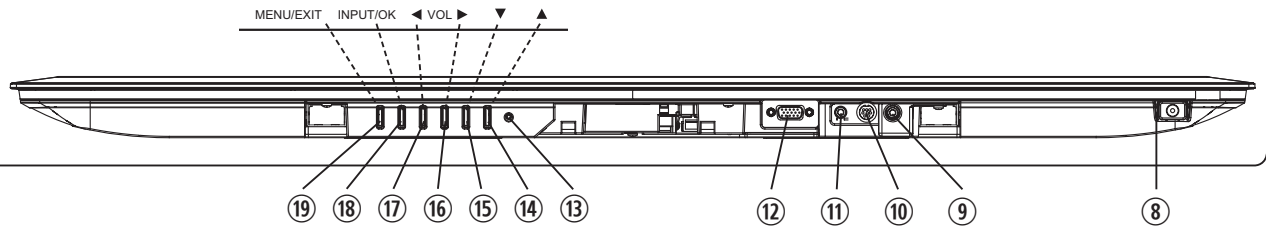

- ⑧ Main Power switch
- ⑨ Service use only
- ⑩ RS232C
- ⑪ PC (RGB)/DVI Analog Audio Input Terminal
- ⑫ PC Connection Terminal (D-sub 15 Pin)
- ⑬ Reset button (See [44](#).)
- ⑭ ▲ button
- ⑮ ▼ button
- ⑯ Volume Up/▶ button
- ⑰ Volume Down/◀ button
- ⑱ Input Select/OK button
- ⑲ Menu/Exit button

Rear Panel

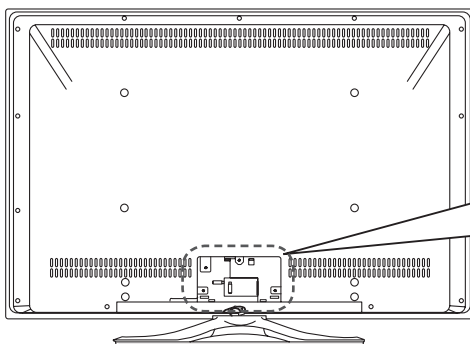

- ① Power Cord Socket
- ② HDMI Input Terminal

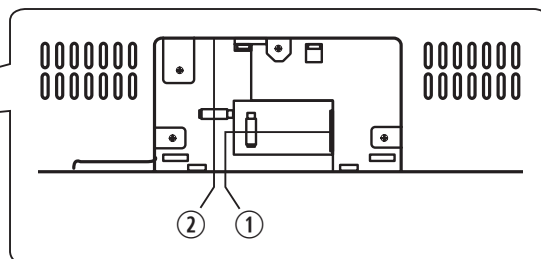

*This drawing shows UT37V702

Please refer to [18](#)~[21](#) for detailed information regarding the connections.

COMPONENT NAMES (continued)

Remote Control

In addition to controlling all of the functions on your Hitachi UT LCD Monitor, the new remote control is designed to operate different types of devices, such as, DVD players, Cable Boxes, Set-Top-Boxes, Satellite Receivers, VCR's, PVR's and AVR's. The remote control must be programmed to control the chosen device. Please refer to pages 25~28 for external device programming setup.

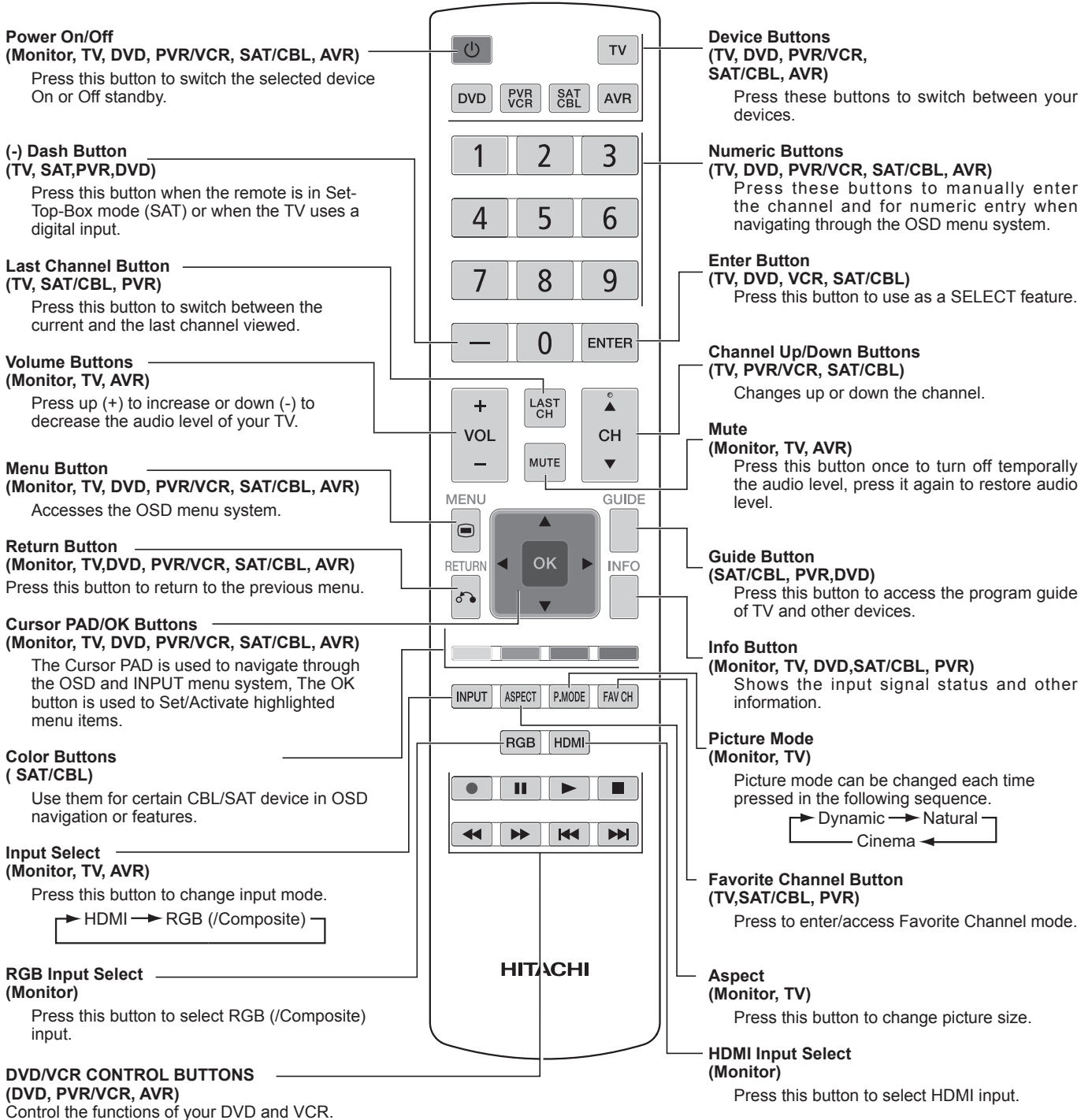

LEGENDS

TV - Television

DVD- Digital Video Disc Player

AVR - Audio/Video Receiver

VCR - Video Cassette Recorder

SAT - Satellite Receiver

PVR - Personal Video Recorder

CBL - Cable Box

NOTE

- Pressing any button will illuminate the backlight for 4 seconds.
- TV Mode is used for LCD Monitor. Please notice that NOT all keys are available for this LCD Monitor, the only working keys are the ones marked as **Monitor** in parenthesis, since other ones are available when equipped with Hitachi Set-Top-Box and Monitor is used as a TV.
- For the Record button there is a feature for safety; so this key have to be press twice in order to start recording.

PREPARATION

Remote Control Battery Installation

The remote control operates on 2 “AAA” batteries.

1. Open the battery compartment cover

- Push and pull open the battery compartment cover on the backside in the direction of the arrow, and remove the cover.

2. Install the batteries

- Install 2 “AAA” batteries (included) making sure the polarities match the indication inside the compartment.

3. Close the battery compartment cover

- Make sure the tabs rest in the corresponding holes and push down the compartment cover until it clicks shut.

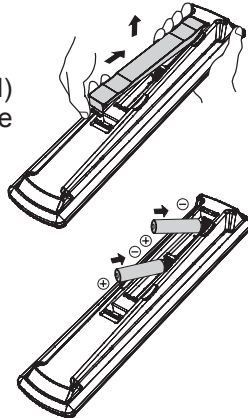

Handling the Remote Control

Use the remote control within a distance of about 5m (16') from the front of the unit's remote control sensor and within an angle of about 30 degrees on both sides.

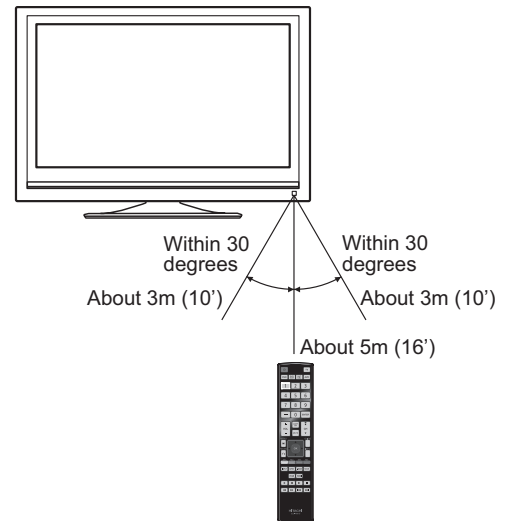

CAUTION

Risk of corrosion or battery leakage. Tampering with batteries may result in physical injury and/or property damage including fire.

- Never mix used and new batteries in the device.
- Replace all the batteries in the device at the same time.
- Remove the batteries if the remote control is not going to be used for an extended period of time.

To avoid possible malfunction, read the following instructions and handle the remote control correctly.

- Do not drop or allow impact to affect the remote control.
- Do not spill water or any liquid on the remote control.
- Do not place the remote control on a wet surface.
- Do not place the remote control under direct sunlight or near sources of excessive heat.

Caution When Moving the Main Unit

Whenever the unit is moved, two people are required to transport it safely.

Whenever the unit is moved, it should be lifted forwards by holding the top and base on both sides of the unit for stability.

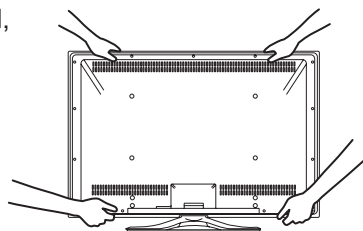

CONNECTION

The unit is suitable for various kinds of connections. Make a connection in the following steps. Be sure to turn off the main power first when connecting external equipment.

1. Connect power cord to the rear panel.
2. Connect your external equipment (if any) to the unit.
3. Attach cushion, secure with clamps and fit terminal cover.
4. Connect the power plug to the wall socket.

1. Connect Power Cord to the Rear Panel

Connect the power cord to the unit.
Do not connect the power plug to the wall socket until all other connections are completed.

2. Connect your Equipment to the Monitor

Connecting to Equipment Having HDMI or DVI Output Terminals

The **HDMI** terminal can be connected to devices with HDMI output.
If the external device has a DVI output, this can be connected using the HDMI-DVI cable. If the HDMI-DVI cable is used, connect analog audio signal to the **PC (RGB)/DVI Analog Audio Input** terminal.
Please be sure to attach the supplied cushion around the HDMI cable when connecting. See [20](#).

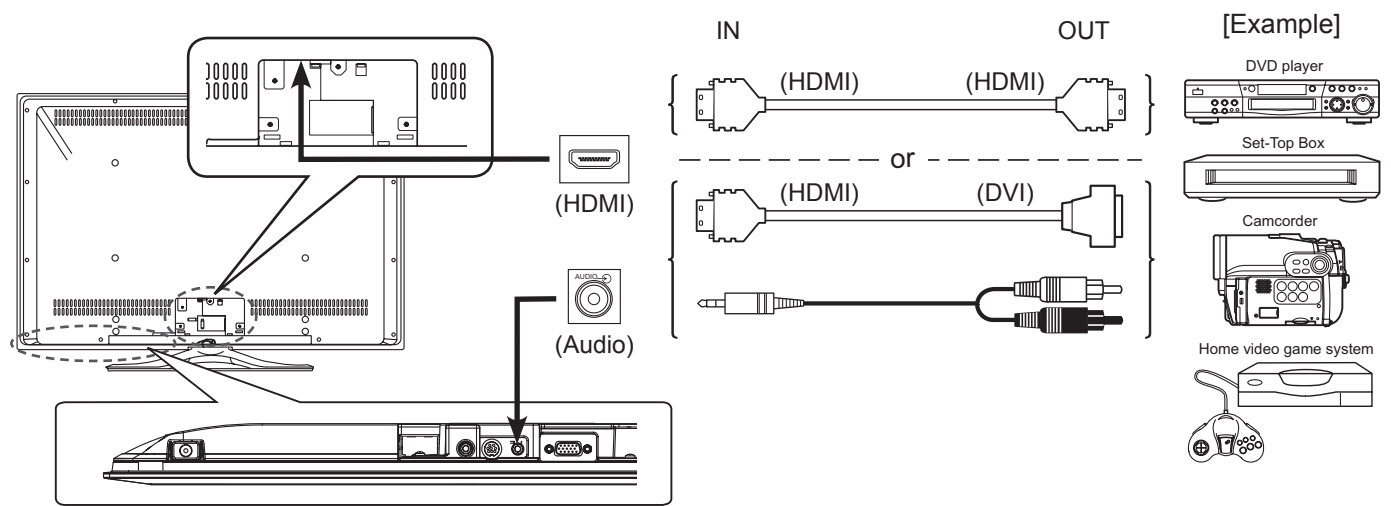

Information

The HDMI (High Definition Multimedia Interface) is a multimedia I/O (Input/Output) interface. Only one cable is used to transmit all video/audio/control signals, thus facilitating easy connection. Moreover, the digital signals can produce high quality data without any degradation.

If your external device has an HDMI terminal, HDMI connection is recommended for higher quality picture and sound.

NOTE

- PC (RGB)/DVI analog audio input terminal

This terminal can be used in either one of the following cases only.

- ① The external device is connected to the PC Connection terminal of the unit.
- ② The DVI output of an external device is connected to the HDMI terminal using the HDMI-DVI cable.

Make sure that the video and audio terminals are connected to the same external device.

For details of the output format of an external device, refer to "Recommended Signal List" on [48](#).

The diagram shows a close-up of the rear panel terminals. Labels with arrows point to the 'PC (RGB)/DVI Analog Audio Input terminal' and the 'HDMI terminal'. A 'PC Connection terminal' is also labeled.

CONNECTION (continued)

2. Connect your Equipment to the Monitor (continued)

Connecting to Equipment Having a HDMI Output Terminal

HDMI-Interfaced System

With "HDMI Control" function, you can interface the connected equipment through the HDMI terminal automatically if the connected equipment meets an industry standard "HDMI CEC (Consumer Electronics Control)". Please check if the connected equipment supports HDMI CEC before using this function.

1. Press the  button.

2. Select "Function" menu.

3. Select "HDMI Control".

4. Select "Auto Input Change" or "System Standby".

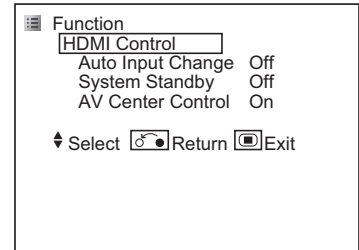

Auto Input Change	Off	Condition : while the monitor is in Standby mode. When the connected equipment starts (such as DVD playback and Disc insertion), the monitor is automatically turned On and switches the picture and audio to HDMI input.
	On	
System Standby	Off	Condition : while the monitor is On. When the monitor is switched off or set to Standby mode, the connected equipment is also turned off or in Standby mode.
	On	
AV Center Control	Off	Selecting On will activate AV Center OSD interface, in case you purchased the optional Hitachi A/V Center.
	On	

NOTE If the HDMI-DVI cable is used, this HDMI-interfaced system is not available.

Game Mode

During TV game play, by pressing "On" you can reduce the time-lag of speed on the moving image.

1. Press the  button.

2. Select "Picture" menu.

3. Select "Game Mode".

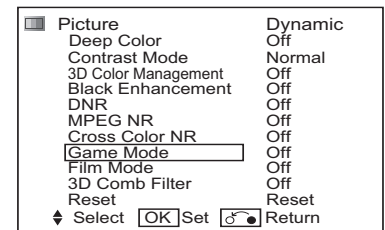

Connecting to Equipment Having Video Output Terminals

The unit can be connected to equipments having video output using the optional D-sub 15 pin - composite cable.

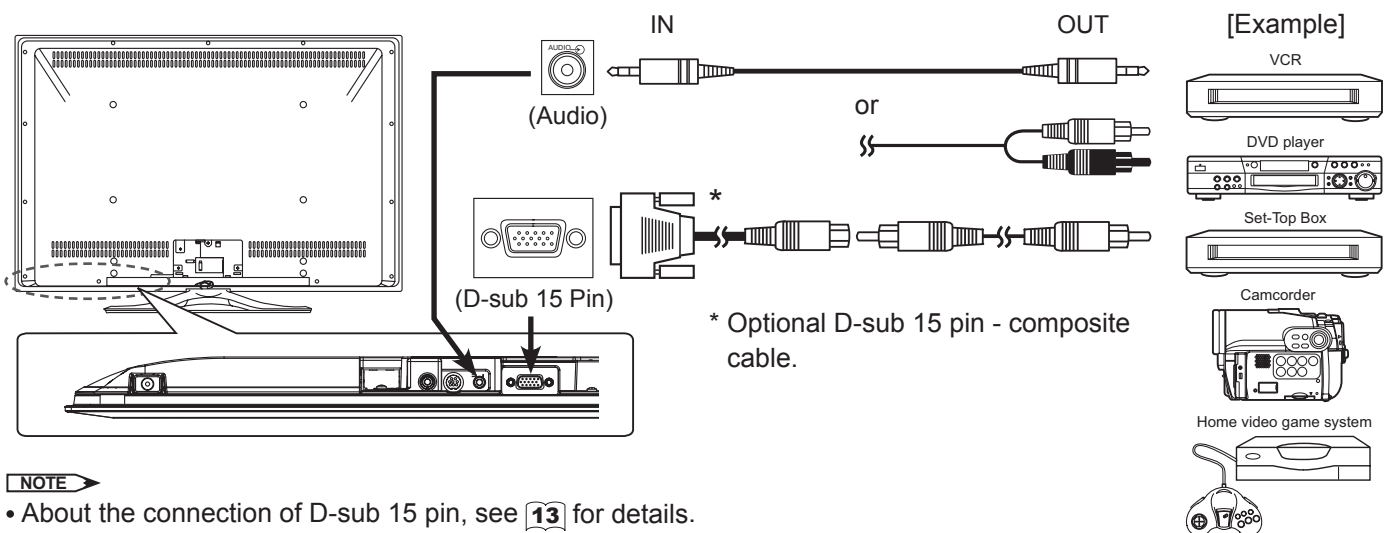

NOTE

- About the connection of D-sub 15 pin, see [13](#) for details.

CONNECTION (continued)

2. Connect your Equipment to the Monitor (continued)

Connecting to a PC

The PC connection terminal (D-sub 15 pin) + the PC (RGB)/DVI Analog Audio Input terminal are connected to the PC, allowing an analog RGB signal.

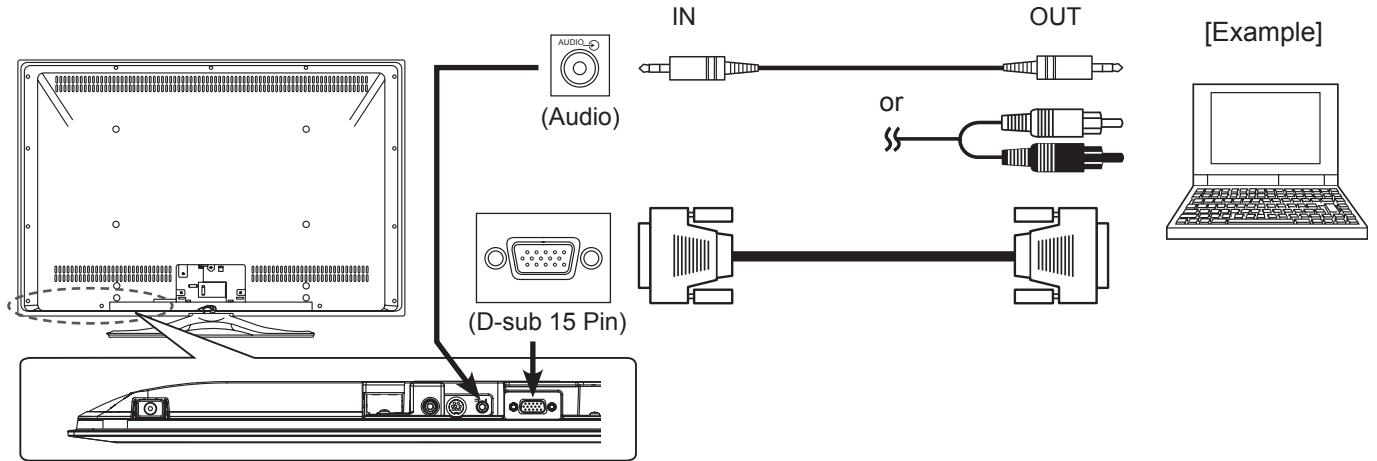

NOTE

- About the connection of D-sub 15 pin, see **13** for details.

3. Attach Cushion, Secure with Clamps and Fit Terminal Cover

1 Attach the supplied cushion around the HDMI cable.

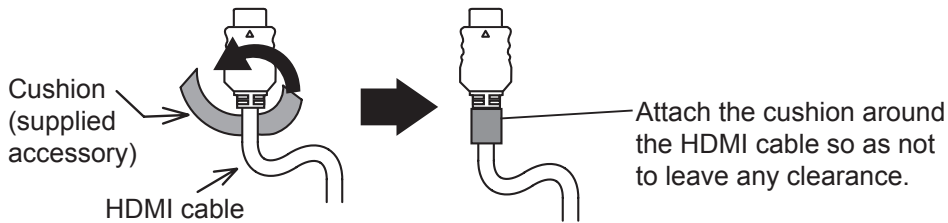

2 Unfasten 2 clamps, and then connect the HDMI cable and power cord to the monitor through open clamps.

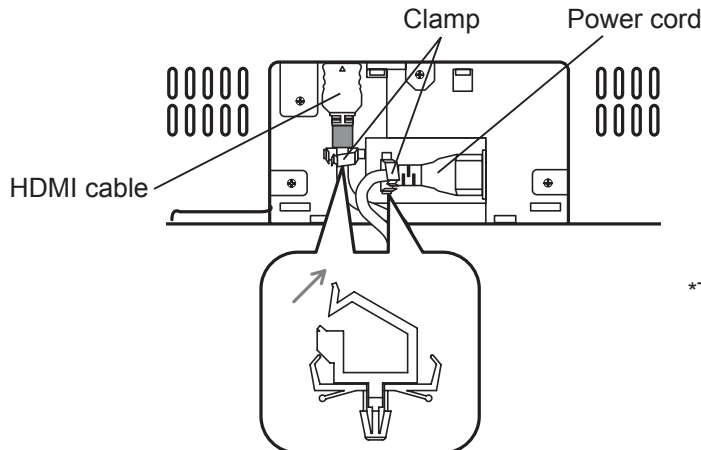

*This drawing shows UT37V702

CONNECTION (continued)

3. Attach Cushion, Secure with Clamps and Fit Terminal Cover (continued)

3 Secure the HDMI cable and power cord with clamps.

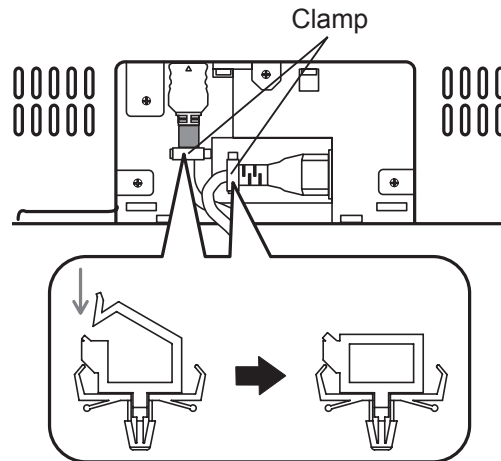

4 Fit the terminal cover onto the monitor.

Insert the tabs into the slots as shown and fold downward to fit the terminal cover.

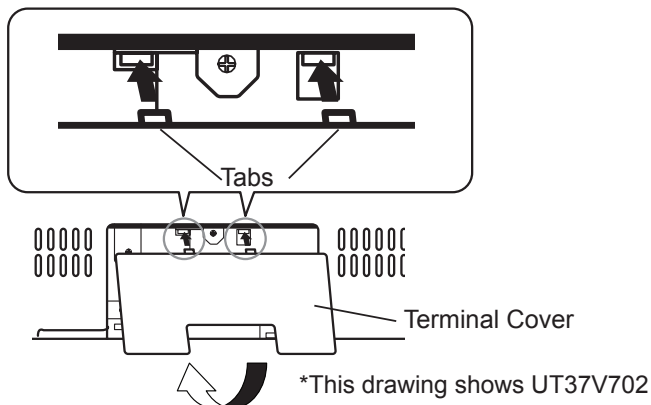

How to remove the cover.

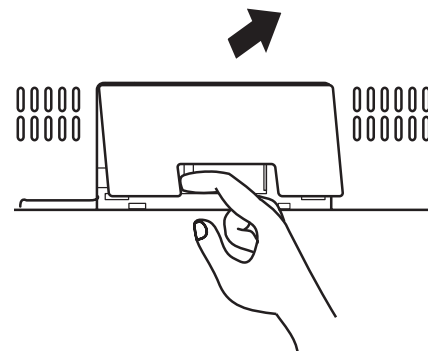

Using your fingers, pull backwards to lift the cover.

4. Connect the Power Plug into the Wall Socket

Connect the power cord after completing all other connections.
(For some countries the type of plug is different that depicted.)

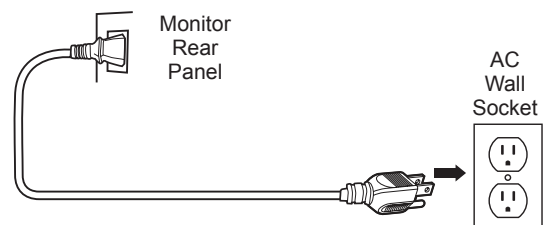

CAUTION

- Use only the power cord provided.
- Do not use a power supply voltage other than that indicated (AC120, 60Hz). It may cause fire or electric shock.
- For the LCD monitor, a three-core power cord with a ground terminal is used for efficiency protection. Always be sure to connect the power cord to a three-pin grounded outlet and make sure that the cord is properly grounded. If you use a power source converter plug, use an outlet with a ground terminal and screw down the ground line.
- Ensure that both ends of the power cord are easily accessible.
- If you have to change the power cord, please use a certified power cord that meets your region's safety standards.

BASIC OPERATION

Power On/Off

Turn On the power of the unit.

• To turn On the power to the unit:

1. Press the **Main Power** switch on the unit.
 - The Indicating Lamp illuminates in Green, and the Illumination Lamp turns Blue. The image will display on screen.
2. Once the **Main Power** switch is on, you can turn On/Off by pressing the **Power (On/Off)** button on the remote control.

• To turn Off the power to the unit:

1. Press the **Power (On/Off)** button on the remote control.
 - The image disappears from the screen. The Indicating Lamp turns **Red** (Standby mode), and the Illumination Lamp turns off.
2. Press the **Main Power** switch on the unit to completely turn Off the power to the unit.

NOTE

- While the Indicating Lamp illuminates in Red (Standby mode), you can turn On/Off by pressing the **Power (On/Off)** button on the remote control.

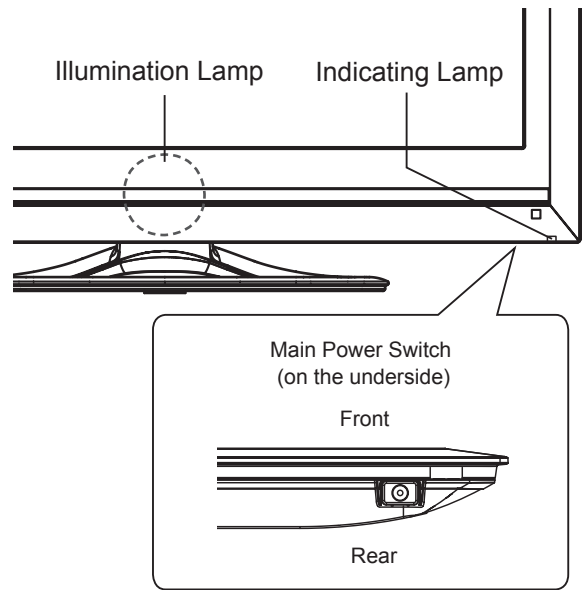

Power On/Off button



The Indicating Lamp/Illumination Lamp Status

Indicating Lamp	Illumination Lamp	Power Status	Remark
Off	–	Off	–
Red	–	Standby mode	–
Green	Blue	On	–
Orange	–	Power Save mode	Refer to 42 and 43 for the condition.
Blinking Green	Blue	On	Receiving Remote Control signal

NOTE

- If the image does not appear on the screen at all, or if there is any problem with it, see “TROUBLESHOOTING” on [43](#)~[45](#). This may help you to solve the problems.
- After turning On, it takes about 6 seconds until the monitor starts up. Please note that buttons on the remote control and the unit (such as the Power button) do not work during this period of time.
- If power is interrupted during use of the unit, to avoid sudden surges of electricity when the power comes back on, turn off the main power to the unit before leaving home.

BASIC OPERATION (continued)

Volume Up/Down

1. To increase the sound volume, press the **Volume Up** button on the remote control or control panel.
 - The Volume Indicator value on the screen will shift to the right.
2. To decrease the sound volume, press the **Volume Down** button on the remote control or control panel.
 - The Volume Indicator value on the screen will shift to the left.

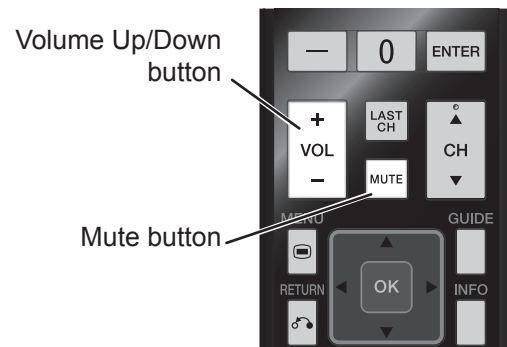

Mute

1. To mute sounds, press the **MUTE** button on the remote control.
 - The sound of the unit is temporarily turned Off.
 - The color of the Volume Indicator will turn into **grey** while muting the volume.
2. To turn the sound back on, press the **MUTE** button again, or press the **Volume Up** button on either the remote control or control panel.
 - The color of the Volume Indicator will turn back to **blue**.

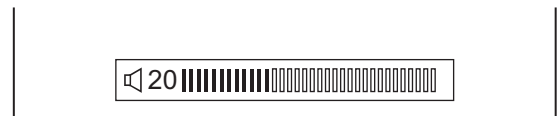
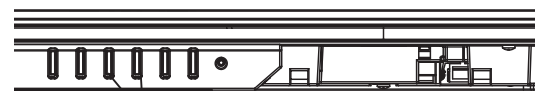

NOTE

- You can decrease the volume by pressing the **Volume Down** button while the sound is muted.

BASIC OPERATION (continued)



Input Switching to HDMI and RGB

By pressing the **Input Select** button , you can switch the input to display the image outputting from the external equipment connected to each terminal (HDMI and RGB (/Composite)).

<From Remote Control>

- Press the  button on the remote control.
Each time this button is pressed, the screen displays the corresponding mode in the following sequence.



- Press the  or  button to directly select the input mode.

<From Control panel>

The Input modes can also be switched using the **Input Select** button on the control panel.
Each time this button is pressed, the screen displays the corresponding mode in the following sequence.

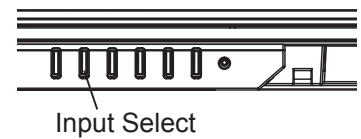
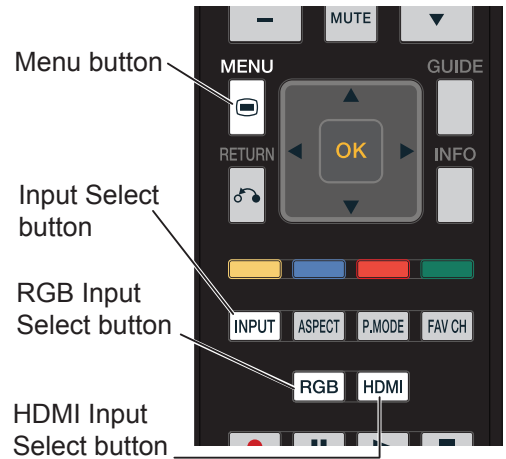

ENGLISH

NOTE Switching between RGB and Composite Mode

When pressing  button, you will see the image from either RGB or Composite mode. You can set up the mode in advance if necessary.

1. Press MENU button in RGB or Composite mode.
2. Select "Setup" menu.
3. Select "RGB input".
 - Select "Composite" to display the image from a video source via the optional D-sub 15 pin - composite cable.
 - Select "RGB" to display the image from PC.

See [38](#) and [39](#) for details of "RGB input" menu.

Input Signal Screen Display

The input signal status can be displayed on the screen by pressing the  button on the remote control.

- The display will go out in approximately 6 seconds.

HDMI mode

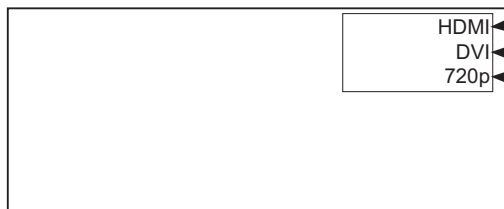

Input mode
*
Signal mode
* HDMI-DVI connection only

RGB mode



Input mode
Input horizontal frequency
Input vertical frequency

Composite mode

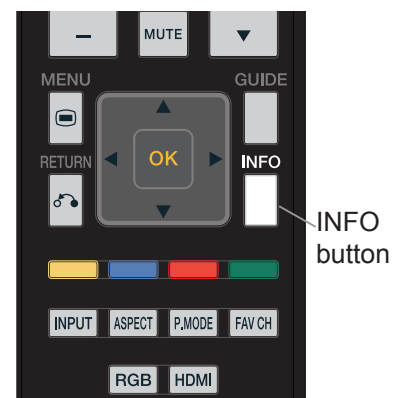
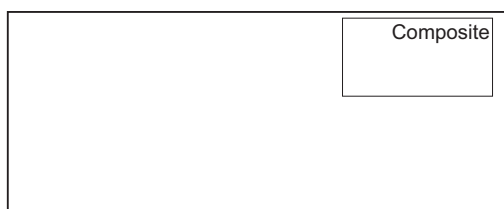

SETUP OPERATION

How to Use the Remote to Control your External Devices

OPERATING THE PRECODED FUNCTIONS FOR YOUR EXTERNAL DEVICES.

The new remote control is designed to operate different types of VCRs, cable boxes, set-top-boxes, satellite receivers, DVD players, and other audio/video equipment. You must first program the remote to match the remote system of your external equipment (refer to pages 29 ~ 30 for precodes).

EXTERNAL DEVICE CONTROL SETUP PROCEDURE

1. Turn on your external device.
2. Select the desired device mode DVD, PVR/VCR, SAT/CBL or AVR by pressing the corresponding device button.
3. Hold down the device button (DVD, PVR/VCR, SAT/CBL or AVR) on the remote and enter the four digit preset code that matches your device as shown on pages 29 ~ 30.
4. Release the device button.
5. If done correctly, the device LED indicator will blink 3 times to confirm proper setup.
6. The remote will now control the desired device.

SETUP EXAMPLE (Hitachi Cable Box with precode 0003)

1. Turn ON your Cable box.
2. Select Cable mode by using your SAT/CBL button to position the LED indicator on SAT/CBL.
3. Hold down the SAT/CBL button on the remote and press the numbers 0, 0, 0 and 3.
4. Release the SAT/CBL button.
5. The indicator light will flash 3 times if the code was accepted.
6. Aim the remote at the cable box and press the POWER button. The remote will turn off your cable box when the correct four digit preset code is entered. When this occurs, the remote control is programmed for your cable box. If the cable box does not turn off, try a different four digit preset code.
7. The remote will now control your Cable box.

Repeat the same procedure for your set-top-box or satellite receiver (select SAT/CBL), your DVD (select DVD), your VCR/PVR(select VCR/PVR), or your AVR (select AVR).

NOTE

- If your external device cannot be operated after performing the above procedures, your external device code has not been precoded into the remote.
- In the unlikely event that your external device cannot be operated after performing the above procedures, please consult your external device operating guide.
- The remote control will remember the codes you have programmed even after the batteries are removed from the remote control. To reset all programmed codes to factory default place remote control in TV mode, then press and hold TV mode key and enter "9", "8", "1" in sequence.

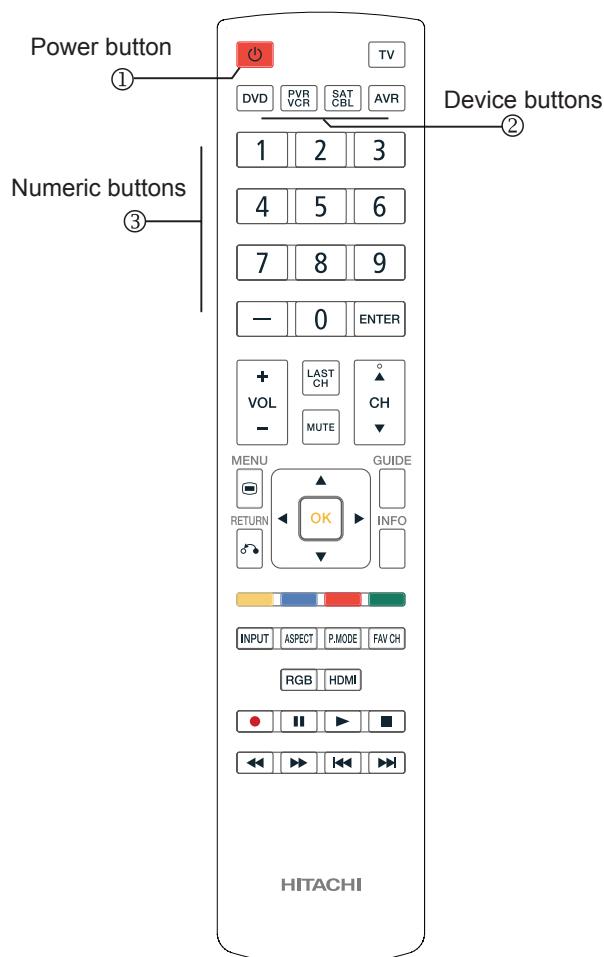

Remote Control Backlight Feature

When you press any remote control button, the buttons will light up. The illumination will light a few seconds during this time. The buttons will appear to light if the room is dark.

Disabling Remote Control Backlight Feature

1. Place the RC in TV mode.
2. Press and HOLD the TV mode key.
3. While holding the TV mode key enter ASPECT, MUTE in sequence.
4. To re-enable the backlight feature do steps 1~3 again (these steps toggle the Backlight Feature on and off, default is ON).

SETUP OPERATION (continued)

How to Use the Remote to Control your External Devices

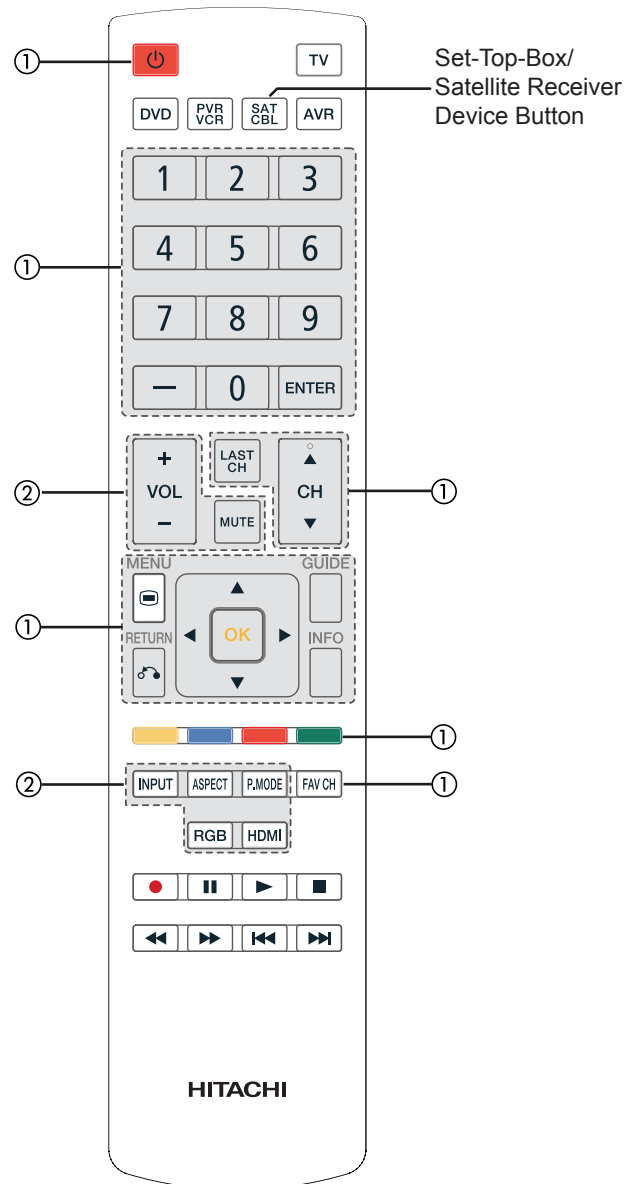
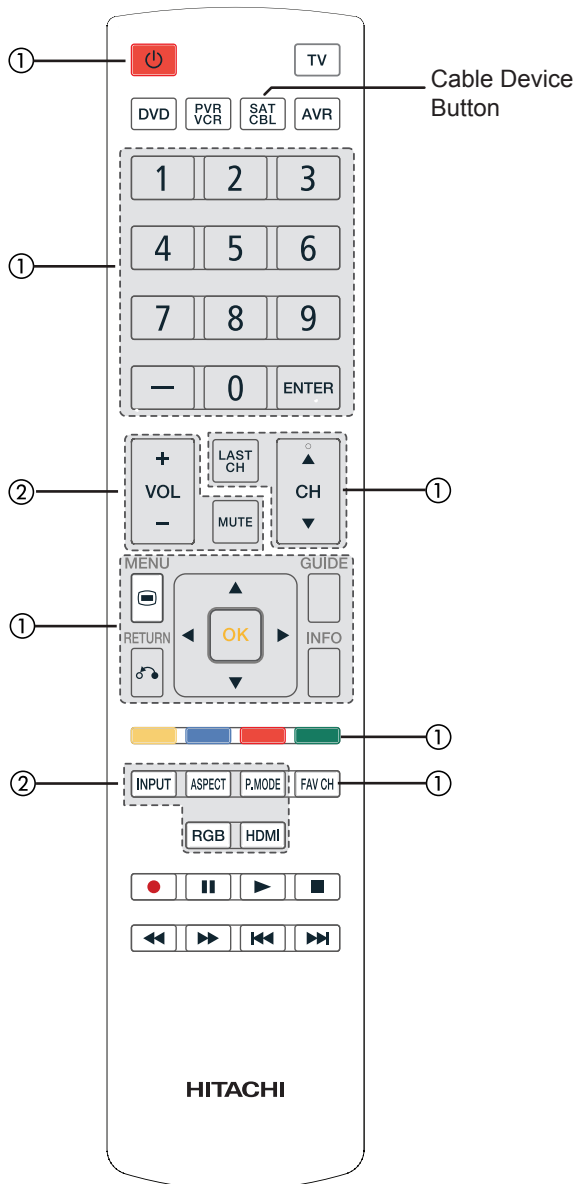

MY CABLE BOX CODE IS: _____

MY SET-TOP-BOX/SATELLITE RECEIVER CODE IS: _____

NOTE

• Refer to the operating guide of the Cable Box for operation of the buttons exclusively for the Cable Box.

NOTE

• Refer to the operating guide of the Set-Top-Box/Satellite Receiver for operation of the buttons exclusively for the Set-Top-Box/Satellite Receiver.

① PRECODED CABLE BOX buttons

These buttons transmit the chosen precoded cable codes :

- Power
- Cursor & OK
- Number PAD
- Menu
- Info
- Enter
- Return
- Channel Up & Down
- Fav CH
- Guide
- Dash(-)
- Color Buttons
- Last CH

② EXCLUSIVE TV mode (Monitor) buttons

These buttons are for operating the TV :

- P. Mode
- HDMI
- Input
- Aspect
- Vol Up & Down
- RGB
- Mute

① PRECODED SET-TOP-BOX/SATELLITE buttons

These buttons transmit the chosen precoded STB/Satellite codes :

- Power
- Cursor & OK
- Number PAD
- Menu
- Info
- Enter
- Return
- Channel Up & Down
- Fav CH
- Guide
- Dash(-)
- Color Buttons
- Last CH

② EXCLUSIVE TV mode (Monitor) buttons

These buttons are for operating the TV :

- P. Mode
- HDMI
- Input
- Aspect
- Vol Up & Down
- RGB
- Mute

SETUP OPERATION (continued)

How to Use the Remote to Control your External Devices

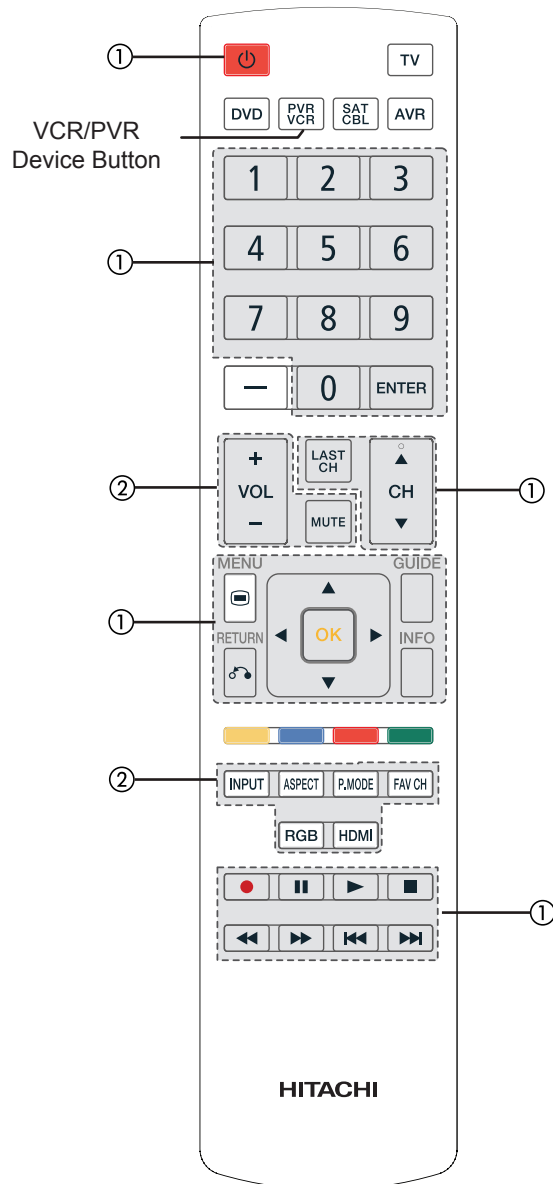
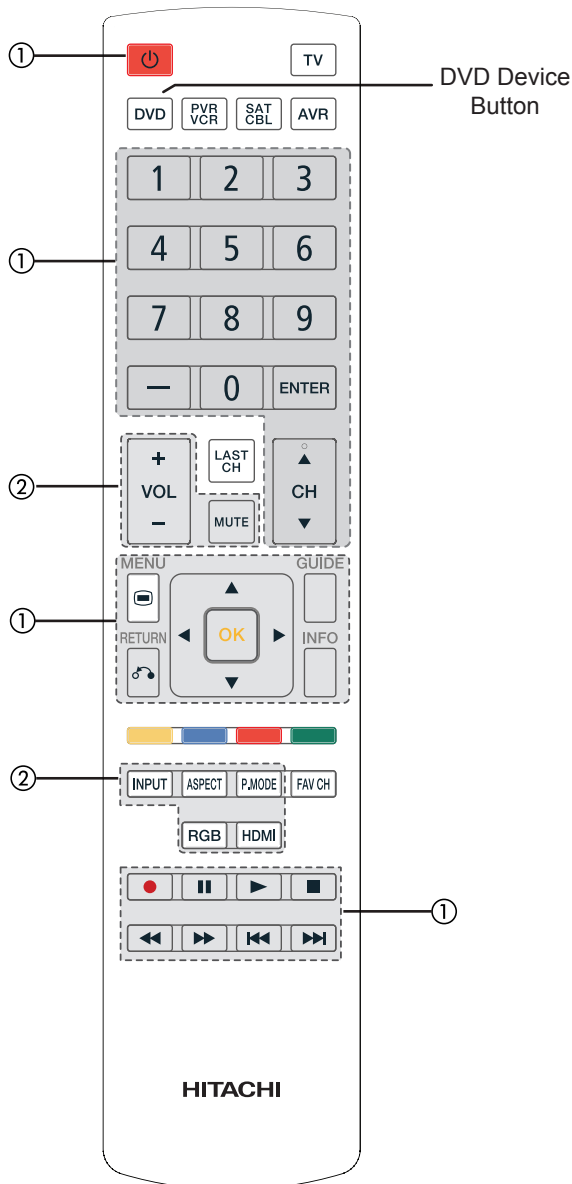

MY DVD PLAYER CODE IS: _____

MY VCR/PVR CODE IS: _____

NOTE

• Refer to the operating guide of the DVD Player for operation of the buttons exclusively for the DVD Player.

NOTE

• Refer to the operating guide of the VCR/PVR for operation of the buttons exclusively for the VCR/PVR.

① **PRECODED DVD buttons**

These buttons transmit the chosen pre-coded DVD codes :

- Power -Cursor & OK -Play, Stop, Pause, RWD, FWD, Skip
- Menu -Info RWD, Skip FWD, Rec
- Return -Number PAD -Enter
- Guide -Dash(-)

② **EXCLUSIVE TV mode (Monitor) buttons**

These buttons are for operating the TV :

- P. Mode -HDMI -Input
- Aspect -Vol Up & Down
- RGB -Mute

① **PRECODED VCR/PVR buttons**

These buttons transmit the chosen pre-coded VCR/PVR codes :

- Power -Cursor & OK -Record
- Menu -Channel Up & Down -Play, Stop, Pause, RWD, FWD, Skip
- Return -Number PAD (FWD,RWD)
- Info -Last CH
- Guide -FAV CH

② **EXCLUSIVE TV mode (Monitor) buttons**

These buttons are for operating the TV :

- P. Mode -HDMI -Input
- Aspect -Vol Up & Down
- RGB -Mute

SETUP OPERATION (continued)

How to Use the Remote to Control your External Devices

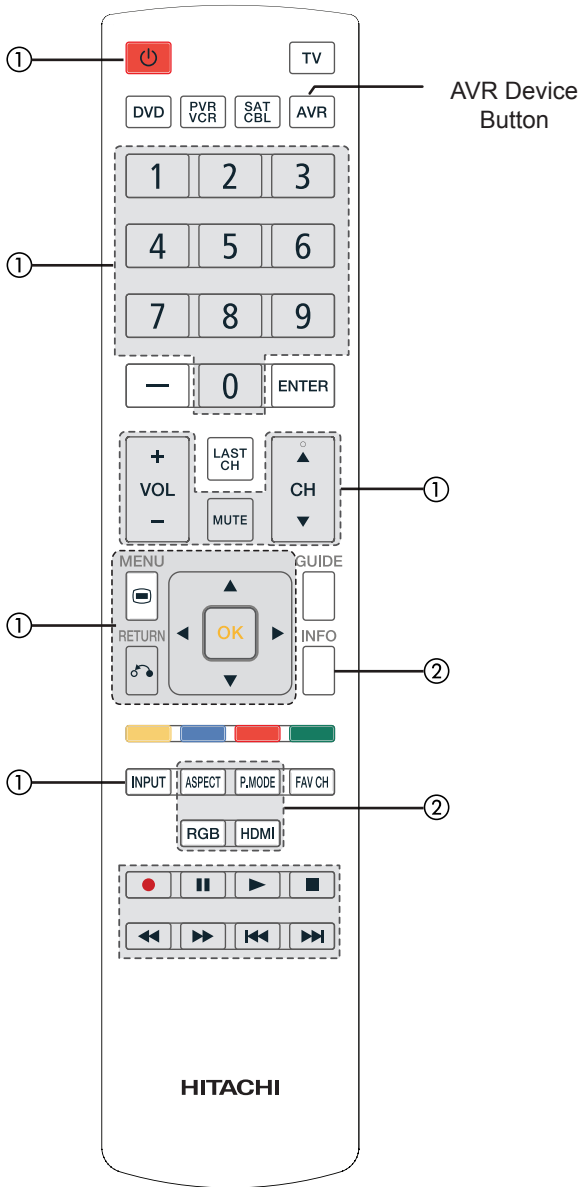

MY AUDIO/VIDEO RECEIVER (AVR) CODE IS: _____

NOTE

• Refer to the operating guide of the AVR for operation of the buttons exclusively for the AVR.

① PRECODED AVR buttons

These buttons transmit the chosen precoded cable codes :

- Power
- Channel Up & Down
- Input
- Number PAD
- Vol Up & Down
- Mute
- Cursor PAD
- Menu
- Return

② EXCLUSIVE TV mode buttons

These buttons are for operating the TV :

- P. Mode
- HDMI
- Info
- Aspect
- RGB

SETUP OPERATION (continued)

Remote Control Codes









WARDS	0060,0035,0037 0048,0047,0081 0033,0240,0045 0000,0042,0043 0041,0072,0038 0479,0065,0046	AMPHION 0872 MEDIA WORKS AMW 0872 APEX DIGITAL 0533,0672,1020 1056,1061	LITEON 1058,1158,1416 1440 1440 0741 0783 0675 0503,0539,0646 0675,1354,1506 1159	VOCOPRO 1360 XBOX 0522,2083 YAMAHA 0490,0539,0545 0497 0872 YAMAKAWA ZENITH 0503,0591,0741 0869 0784 ZOECE 1265	RCA 1023,1609,1390 REALISTIC 1609,0121 REVOX 0189 SAMSUNG 1304,1500,1868 SANGEAN 2165 SANSUI 1189,0189 SHERWOOD 1913 SIRIUS 1602,1811 SONY 1058,1441,1258 1759,1622,1406 1558,1658,1758 1858 SOUNDESIGN 0670 STEREOPHONICS 1023 TEAC 1390 TECHNICS 1308,1518,1633 THORENS 1189 TOSHIBA 0842,1788 VENTURER 1390 WARDS 0189,0014 XM 1406,1414 YAMAHA 1023,0176,1176 1276,1331,1815 2061				
WHITE	0000,0209,0072	ARRGO 1023	MALATA						
WESTINGHOUSE	0278,0479	ASPIRE 1168	MARANTZ						
WORLD	0209,0002,0479	AWA 0730	MCINTOSH						
XR-100	0035,0240,0000 0072	AUDIOVOX 0790	MEMOREX						
YAMAHA	0041,0038	AWA 0730							
ZENITH	0037,0039,0033 0000,0209,0041 0278,0479,1139 1972	B & K 0655,0662 BBK 1224 BEL CANTO DESIGN 1571 BLUE PARADE 0571 BLUE SKY 0695 BROKSONIC 0695 CALIFORNIA 0490 AUDIO LABS CELESTIAL 1020 CENTREX 0672 CINEA 0831 CINEVISION 0876,0833,0869 CITIZEN 1003,0695,1277 1587,2116 CLAIRTONE 0571 COBY 0778,0852,1077 1086,1107,1165 1177,1351 CRAIG 0831 CREATIVE 0503,0539 CURTIS MATHES CYBERHOME 0816,0874,1023 1024,1129,1502 1537 CYTRON 0705 DAEWOO 0784,0705,0770 0833,0869,1169 1172,1234,1242 DANSAI 0770 DAYTEK 0872 DECCA 0770 DENON 0490,0634 DENVER 0778 DIGITREX 0672 DISNEY 0675,1270 DI VIDO 0705 DUAL 0675 DURABRAND 1127 DVD2000 0521 EMERSON 1003,2116 ENTERPRISE 0591,0675 ENTIVO 0503,0539 ENZER 0770 FISHER 1919 FUNAI 0675 GATEWAY 1073,1077,1158 GE 0522,0815 GO VIDEO 0573,0744,0715 0741,0783,0833 0869,1044,1075 1099,1144,1158 1304,1730 GOLDSTAR 0741,0869 GOODMANS 0790 GPX 0769 GRADIENTE 0490 GRUNDIG 0539,0705 HARMAN/ KARDON 0582,0702 HELLO KITTY 0831 HITACHI 0573,0664,1919 HITEKER 0672 INSIGNIA 2095 INTEGRA 0571,0627 IRT 0783 JBL 0702 JMB 0695 JSI 1423 JVC 0558,0623,0867 1164 JWIN 1049,1051 KAWASAKI 0790 KENWOOD 0490,0534 KLH 0790,1020,1149 KLOSS 0533 KONKA 0711,0721 KOSS 0769,1061,1423 LASONIC 0627 LECSOX 1533 LENOXX 1127 LG 0591,0741,0869	MICROSOFT 0522,2083 MINATO 0752 MITSUBISHI 1521,0521 MUSTEK 0730 MYRAD 0894 NAD 0741 NAIKO 0770 NEC 0785,0869 NEXXTECH 1402 NINTAUS 1051 NORCENT 1003,0872,1107 2215 1265 ONKYO 0503,0627,1769 OPPO 0575,1224,1525 2185 0571 OPTIMUS 0672,0852 PALSONIC 0503,0490,0571 PANASONIC 0703,1641,1762 0675 0503,0539,0646 0675,1267,1340 1354,2056,2084 1024 PIONEER 0525,0571,0142 0631,1571 1020,1061,1086 0539 POLAROID POLK AUDIO PORTLAND 0770 PRESIDIAN 0675 PRIMA 2126,2127 0672 PROCEED 0522 PROSCAN 0778 PROVISION 0741 RADIONETTE 0571 RADIOSHACK RCA 0522,0571,0790 0822,1769 0571 REALISTIC 0752 REOC 0869 RIO 1360 RUTECH 0623,1178 ROTEL 0698,0752 SAMPO 0490,0573,0744 SAMSUNG 0199,0820,1044 1075,2069 0695 SANSUI 0675,0695,0873 1919 SCHNEIDER 0783 SCHWAIGER 0752 SENSORY SCIENCE 1158 SHARP 0630,0675,0752 1256 SHERWOOD 0633,0770,1043 1077 SHINSONIC 0533 SLIM ART 0784 SM ELECTRONIC 0730 SONIC BLUE 0573,0715,0783 0869,1099 SONY 0533,1533,0864 1033,1070,1431 1516,1536 0675 SYLVANIA 0675 SYMPHONIC 0675 TAG MCLAREN 0894 TATUNG 0770 TEAC 0571,0790 TECHNICS 0490,0703 0770 TECHNIKA 0770 TECHSONIC 0730 THETA DIGITAL 0571 THOMSON 0522 TIVO 1503 TOSHIBA 0503,0573,0539 0695,1154,1503 1608,1769 0800,0803 0770 TREDUX 0770 UNIMAX 0730 UNITED 0730 UNIVERSUM 0591 URBAN CONCEPTS 0503,0539 V 1064,1226 VENTURER 0790 VIZIO 1064,1226	BLU-RAY DISC CODES LG 0741 PANASONIC 1641 PHILIPS 2084 PIONEER 0142 SAMSUNG 0199 SONY 1516	DVD/PVR COMBO CODES GO VIDEO 1730 PANASONIC 0490 PHILIPS 1340 PIONEER 0631 RCA 0522 SHARP 1256 SONY 1033,1070,1536 SYLVANIA 0675 TOSHIBA 1503	HD-DVD CODES LG 0741 MICROSOFT 2083 ONKYO 1769 RCA 1769 TOSHIBA 1769 XBOX 2083	AUDIO RECEIVER Brand CODES AIWA 1405,0189,0121 1243,1388,1641 1390 ALCO 1609 ANAM 1609 APEX DIGITAL 1774 ARCAM 1189 AUDIOTRONIC 1189 AUDIOVOX 1390 B & K 0820,0840 BOSE 0639,1253,1933 BRIX 1602 CAIRN 0189 CARVER 1189,0189,0121 CURTIS MATHES 0014 DELPHI 1414 DENON 1360,0121,1142 1306 ELECTROHOME 2026 GRUNDIG 0189 HARMAN/ KARDON 0189,0891,1304 1306 HITACHI 0228 INSIGNIA 1030,2169 INTEGRA 0842,1298,1320 1805 1306 JBL 1058,1374,1495 1811 JVC 1390 KAWASAKI 1570,1569 KENWOOD 1390,1428 KOSS 1497 LG 2197 LINN 0189 LIQUID VIDEO 1497 MAGNAVOX 1189,1269,0189 1266,1514 1189,1269,0189 0891 MICROMEGA 1189,0189 MITSUBISHI 1393 MYRAD 1189 NAKAMICHI 0097,1555 ONKYO 0842,1298,1320 1805 OPTIMUS 1023,0014,0121 0670 ORITRON 1497 PANASONIC 1308,1518,1288 1316,1548,1633 1763,1764,2967 1189,1269,0189 0891,1266 PIONEER 1023,0014,0630 1384,1935 POLK AUDIO 0189,1414 RADIO SHACK 1609	AUDIO AMPLIFIER Brand CODES ADCOM 0577,1100 BOSE 0674 CARVER 0892 CARY AUDIO 1879 DESIGN CLASSE 1461 FLETRONICS 1879 HALCRO 1934 HARMAN/ KARDON 0892 KRELL 1837 LEFT COAST 0892 LEXICON 1145,1802 MARANTZ 0892 MARK LEVINSON 1483 PARASOUND 1934 PHILIPS 0892 POLK AUDIO 0892 PRIMARE 1395 YAMAHA 0354	TELEVISION CODES HITACHI 1445,1643,2143 2243
DBS/PVR COMBO	CODES								
DIRECTV	0739								
HUGHES NETWORK SYSTEMS	0739								
PHILIPS	0739								
SAMSUNG	0739								
TIVO	0739								
DVD/PVR COMBO	CODES								
HUMAX	1797,1988								
PIONEER	1337								
RCA	0880								
SYLVANIA	0000								
TIVO	1337								
TOSHIBA	1008,1988								
DVD Brand	CODES								
3D LAB	0503,0539								
ACCURIAN	0675,1416								
ACOUSTIC SOLUTIONS	0730								
ADCOM	1094								
AFREEY	0698								
AIWA	0641								
AKAI	0695,0705,0770 1089								
ALBA	0672								
ALCO	0790								
ALLEGRO	0869								

SETUP OPERATION

How to Use the On-Screen Display (OSD) System

You can use the On-Screen Display system to access the various kinds of the features and functions.

• Basic Operation

1. Press the  button on the remote control or the **Menu** button on the control panel of the unit. The **Main Menu** is displayed on the screen as shown on the right.
2. To select the item, press the  button.
The selected item will be highlighted in Yellow.
3. Press the  button to set your selection.
The selected menu page will be displayed on the screen.
4. Use the  button to choose the item on the menu page.
Press the  button to set your selection.
5. Use the  button to adjust the item values or choose options.
Press the  button to set your selection.
6. To exit from the menu, press the  or the  button.

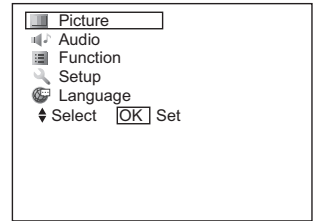

<Main Menu>

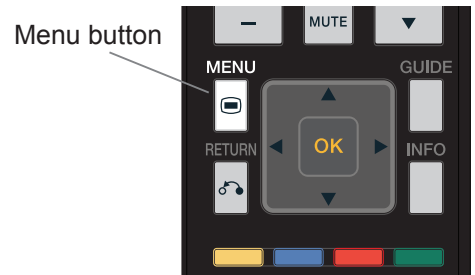



NOTE

- The OSD menu screen will be closed automatically when no operation has been made for about one minute.
- If the item on the menu is shown in gray, it means that it cannot be selected or adjusted.

Select Language

Select the language from the list so that the OSD menu can be displayed in the selected language.
The default setting is English (US).

• How to set Language

1. Enter the “**Language**” menu from the Main Menu.
2. Select your preferred language from the list using the  button.
The selected item will be highlighted in Yellow.
3. Press the  button to set your selection.
The mark on the left turns into a double circle when the selection is fixed.
4. Press the  button to exit from the entire OSD menu.



SETUP OPERATION (continued)

Main Menu List

Menu		Page		
Picture (HDMI/Composite)	Picture Mode	Select between 3 picture modes according to the lighting condition.	33	
	Contrast	Adjust to increase or decrease the picture contrast.	33	
	Brightness	Adjust to brighten or darken the picture.	33	
	Color	Adjust to increase or decrease the color density.	33	
	Sharpness	Adjust to sharpen or soften the picture.	33	
	Tint	Adjust to obtain natural skin color.	33	
	Color Temperature	Select between 3 settings according to your preferred color tone.	33	
	Back Light	Adjust to increase or decrease the brightness of back light on LCD panel.	33	
	Reset	Reset each item on the menu screen to the factory setting.	33	
	Deep Color	Enhance the color depth of picture.	34	
	Contrast Mode	Select between 3 contrast modes to suit your preference.	34	
	3D Color Management	Adjust the suitable tint, color density, and brightness on image.	34	
	Black Enhancement	Adjust the black level compensation.	34	
	DNR	Reduce noise for picture signal.	35	
	MPEG NR	Reduce mosquito noise in the picture.	35	
	Cross Color NR	Reduce noise caused by color mixture of adjacent pixels.	35	
	Game Mode	Reduce the time-lag of speed on the moving image during TV game play.	19	
	Film Mode	Adjust to make the moving image smooth.	36	
	3D Comb Filter	Reduce the color blurring to reproduce purer color.	34	
	Reset	Reset each item on the menu screen to the factory setting.	34	
Color Temp. Adjust	Set specific adjustment in each of 3 color temperature modes.	34		
Picture(RGB)	Contrast	Adjust to increase or decrease the picture contrast.	38	
	Brightness	Adjust to brighten or darken the picture.	38	
	Color	Adjust to increase or decrease the color density.	38	
	Tint	Adjust to obtain natural skin color.	38	
	Color Temperature	Select between 3 settings according to your preferred color tone.	38	
	Color Temp. Adjust	Set specific adjustment in each of 3 color temperature modes.	38	
	Back Light	Adjust to increase or decrease the brightness of back light on LCD panel.	38	
	Reset	Reset each item on the menu screen to the factory setting.	38	
Audio	Treble	Adjust to increase or decrease the level of treble. (-15~+15)	-	
	Bass	Adjust to increase or decrease the level of bass. (-15~+15)	-	
	Balance	Adjust the balance of sound from the bottom right and left speakers. (-10~+10)	-	
	Surround	Select surround-sound. (Off/On)	-	
	Bass Boost	Enhance bass sounds. (Off/On)	-	
	Clear Voice	Select clearer and more realistic sounds. (Off/On)	-	
	Perfect Volume	Adjust sound volume appropriately. (Off/On)	-	
	Speakers	Select if using internal speakers. (Off/On)	-	
	Reset	Reset each item on the menu screen to the factory setting.	-	
Function	System	This function is not available.	-	
	HDMI Control	Auto Input Change	In response to the connected equipment (such as DVD) through HDMI cable, the monitor is automatically turned On and switched to HDMI input.	19
		System Standby	In response to the monitor, the connected equipment (such as DVD) through HDMI cable is automatically turned Off (standby mode).	19
		AV Center Control	Selecting On will activate AV Center OSD interface, in case you purchased the optional Hitachi A/V Center.	19
Setup (HDMI/Composite)	Video Power Save	Save power consumption when no signal can be input in HDMI/Composite input mode.	42	
	RGB Input	Select the effective signal.	37	
	Color System	Select color system.	37	
Setup(RGB)	Auto Adjust	Adjust Horizontal Position, Vertical Position, Horizontal Clock, and Clock Phase automatically.	39	
	Horizontal Position	Adjust the display position horizontally.	39	
	Vertical Position	Adjust the display position vertically.	39	
	Horizontal Clock	Minimize the vertical stripes on the screen.	39	
	Clock Phase	Minimize the blurring of the letters and stripes on horizontal row.	39	
	Reset	Reset each item on the menu screen to the factory setting.	39	
	Frequency Display	Set On for PC signal frequency information to be displayed on the Input Signal Screen Display.	39	
	WXGA Mode	Select the resolution when WXGA signal is received.	39	
	RGB Input	Select the effective signal.	39	
Language	-	31		

NOTE • The picture settings can be stored for each of inputs except “Picture Mode”.

SETUP OPERATION (continued)

Watching Images from HDMI/Composite Input

1. Connect to external equipment. (See [18](#) and [19](#) for details.)
2. Press the **HDMI** or **INPUT** button to switch to HDMI mode.
Press the **RGB** or **INPUT** button to switch to Composite mode.
3. Press the **MENU** button.

Setting Picture Adjustment

You can adjust the display condition such as color settings.

Select "Picture" from Menu list.

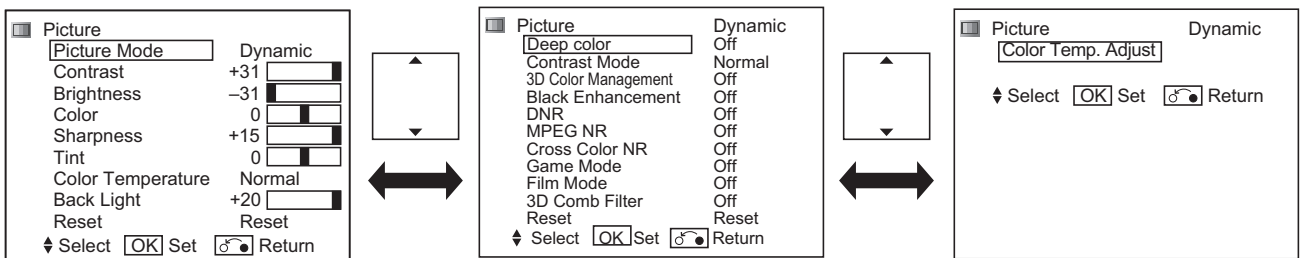

Selected Items		Setup hint
Picture Mode	Dynamic	You can make the best selection from 3 modes depending on the lighting condition and intended use. Dynamic: Suitable for brighter conditions. Natural : Suitable for normal lighting conditions. Cinema : Suitable for watching movies.
	Natural	
	Cinema	
Contrast	-31~+31 (+32~+40)	This adjusts the contrast to meet the surrounding brightness by using the button. • The maximum value is extended up to [+40] by pressing the button for more than 2 seconds at [+31]. The value between [+32] ~ [+40] appears in magenta. This is the special feature for dark images, so it is recommended to set the value less than [+31] under normal conditions.
Brightness	-31~+31	Adjust brightness according to personal preference by using the button.
Color	-31~+31	Adjust color according to personal preference by using the button.
Sharpness	-15~+15	Preferred sharpness can be adjusted by pressing the button for softer image or the button for sharper image.
Tint	-31~+31	Pressing the button enhances red and weakens green, while pressing the button weakens red and enhances green. The setup hint is to adjust for realistic skin color.
Color Temperature	Cool	You can select from 3 settings depending on the color condition using the button. • This function is not available when "Deep Color" is "On" in HDMI mode.
	Normal	
	Warm	
Back Light	-20~+20	Adjust the brightness of the Back Light for maximum visibility.
Reset		Each item on this menu screen can be restored to the factory settings by pressing the button.

SETUP OPERATION (continued)

Watching Images from HDMI/Composite Input (continued)

Setting Picture Adjustment (continued)

Selected Items		Setup hint	
Deep Color	Off	Enhance the color depth of picture during HDMI input.	
	On		
Contrast Mode	Dynamic	It allows you to choose from 3 modes. Dynamic: Sharpen the gradation to improve the contrast feeling. Normal : Improve the contrast feeling to reproduce a faithful gradation. Linear : Reproduce as faithful gradation as possible. • This function is not available when "Deep Color" is "On" in HDMI mode.	
	Normal		
	Linear		
3D Color Management	Off	On : It automatically adjusts the suitable tint, color density, and brightness on images. Off : Set it off if the image does not look natural. • This function is not available when "Deep Color" is "On" in HDMI mode.	
	On		
Black Enhancement	Off	Adjusts the black level compensation. • This function is not available when "Deep Color" is "On" in HDMI mode.	
	Low		
	Middle		
	High		
3D Comb Filter	Off	This function is available only if D-sub 15 pin - composite cable is used. This reduces the dot and color blurring in minute scales so that it can reproduce purer color. • This is not available for NTSC4.43, PAL60, SECAM, PAL-N and PAL-M system. • This is available only when receiving NTSC3.58/PAL composite signal.	
	Low		
	Middle		
	High		
Reset		Each item on this menu screen can be restored to the factory settings by pressing the <input type="button" value="OK"/> button.	
Color Temp. Adjust	On	Amplitude	On: When you want to set specific adjustments in each of the 3 Color Temperature modes. You can adjust on the Amplitude and Cut Off. The settings reflect on the Color Temperature. Amplitude: Subdue the colors (Red/Green/Blue) on the brighter parts (-63~0). Cut Off : Subdue the colors (Red/Green/Blue) on the darker parts (-31~+31). Reset (Available when On): Select to restore amplitude and Cut Off adjustments to default settings by pressing the <input type="button" value="OK"/> button. Off: Remains as default setting.
		Red	
		Green	
		Blue	
		Cut Off	
		Red	
		Green	
		Blue	
	Reset		
	Off	• This function is not available when "Deep Color" is "On" in HDMI mode.	

SETUP OPERATION (continued)

Watching Images from HDMI/Composite Input (continued)

Reducing Noise

You can reduce the unwanted picture noise.

Select **"Picture"** from the Menu list.

Picture	Dynamic
Deep color	Off
Contrast Mode	Normal
3D Color Management	Off
Black Enhancement	Off
DNR	Off
MPEG NR	Off
Cross Color NR	Off
Game Mode	Off
Film Mode	Off
3D Comb Filter	Off
Reset	Reset
◆ Select	OK Set ◀▶ Return

Selected Items		Setup hint
DNR	Off	This is a noise reduction system for picture signals.
	Low	
	Middle	
	High	
MPEG NR	Off	This is a noise reduction system for MPEG picture signals. (e.g. against mosquito noise and block noise.)
	Low	
	High	
Cross Color NR	Off	This reduces noise caused by color mixture of adjacent pixels. This is not available when "Game Mode" is On.
	Low	
	High	

SETUP OPERATION (continued)

Watching Images from HDMI/Composite Input (continued)

Making the Moving Image Smooth

Using this function helps to make the moving image smooth.
Select "Picture" from the Menu list.

Picture	Dynamic
Deep color	Off
Contrast Mode	Normal
3D Color Management	Off
Black Enhancement	Off
DNR	Off
MPEG NR	Off
Cross Color NR	Off
Game Mode	Off
Film Mode	Off
3D Comb Filter	Off
Reset	Reset
◆ Select	[OK] Set [Return]

Selected Items		Setup hint
Film Mode	Off	This helps to make the moving image smooth. Original : Automatically identifies the source of movie (3:2 pulldown, 2:2 pulldown) and faithfully reproduces the original film images. Smooth1: Automatically identifies the source of movie (3:2 pulldown, 2:2 pulldown) and reproduces the smooth motion. Smooth2: Reproduces the clear moving image when the input signal is 50Hz or 60 Hz. Off: Set to Off if the image does not look natural. This is not available in the following cases. <ul style="list-style-type: none"> • OSD is displayed. • "Game Mode" is On.
	Original	
	Smooth1	
	Smooth2	

NOTE About "Film Mode"

- The image might not look natural depending on the image contents.

Phenomena such as

- ① When switched to the subtitles of a film or images, the image displays fine horizontal streak lines.
- ② When switched to scenes such as commercial and animation, the image displays fine horizontal streak lines.
- ③ When displaying a ticker or subtitle, the text on the image becomes rough (aliasing).
- ④ When watching the image in Composite mode, which is connected to any external equipment, the OSD of external equipment displays fine horizontal streak lines.

These phenomena occur due to the method of converting the image. Please note that this is not a malfunction. In the event that this is disturbing, please set to Off.

In addition, the effect of this menu might vary depending on the aspect setting (See [40](#)).

Also, this might be ineffective depending on the scene of the image.

SETUP OPERATION (continued)

Watching Images from HDMI/Composite Input (continued)

Advanced Setting

Select "Setup" from the Menu list.

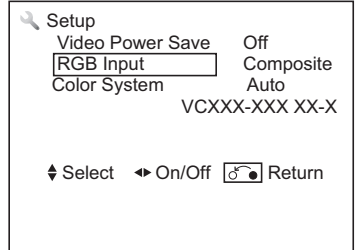

Selected Items		Setup hint
Video Power Save	Off	See 42 for details.
	On	
RGB Input	RGB	Select the effective signal.
	Composite	
Color System	Auto	This function is available only if D-sub 15 pin - composite cable is used.
	PAL	
	SECAM	Selects the color system depending on the input signal. • Generally, select [Auto] to receive all signals. • If the input signal has too much noise, the signal level is too low or the operation is unstable in [Auto], select the system according to the color system of the input signal. • Composite input only.
	NTSC 4.43	
	NTSC 3.58	
	PAL60	
	PAL-M	
PAL-N		

NOTE Watching through the optional D-sub 15 pin - composite cable

If your external equipments do not have an HDMI terminal or a DVI terminal, you can watch images from your external equipments through the optional D-sub 15 pin - composite cable.

1. Connect to your external equipment with the optional D-sub 15 pin - composite cable. (See [19](#).)
2. Switch to RGB input by pressing the **RGB** or **INPUT** button.
3. Press the button and select "Setup" from the menu list.
4. Then you can select "Composite" in "RGB Input".

NOTE Checking Software Version

- The Software Version is displayed on Setup(HDMI/Composite) menu.

Software Version

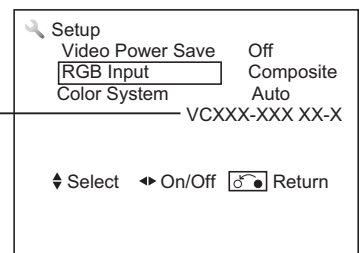

SETUP OPERATION (continued)

Viewing Images from a PC

1. Connect to the PC. (See [20](#) for details of connection to PCs.)
2. Switch to RGB input by pressing the **RGB** or **INPUT** button.
3. If necessary select "RGB" option under "Setup/RGB Input" menu.







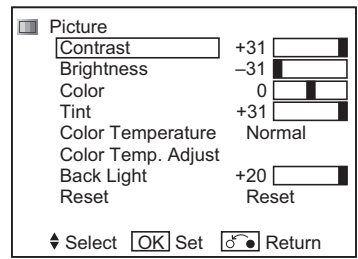

4. Press the  button.

Setting Picture Adjustment

You can adjust the display condition such as position adjustment and color settings.



- ① **Picture Menu**
Select "Picture" from the Menu list.

Selected Items		Setup hint	
Contrast	-31~+31 (+32~+40)	This adjusts the contrast to meet the surrounding brightness using the  button. • The maximum value is extended up to [+40] by pressing the  button for more than 2 seconds at [+31]. Values between [+32] ~ [+40] appear in magenta. This is the special feature for dark images, so it is recommended to set the value less than [+31] under normal conditions.	
Brightness	-31~+31	Adjust the brightness according to personal preference using the  button.	
Color	-31~+31	Adjust the color according to personal preference using the  button.	
Tint	-31~+31	Pressing the  button enhances red and weakens green, while pressing the  button weakens red and enhances green. These adjustments are for realistic skin color.	
Color Temperature	Cool	You can select from 3 settings with the  button.	
	Normal		
	Warm		
Color Temp. Adjust	On	Amplitude	On: When you want to set specific adjustments in each of the 3 color temperature modes. You can adjust the Amplitude and Cut Off. The settings reflect on the Color Temperature. Amplitude: Subdues the colors (Red, Green, Blue) on the brighter parts (-63~0). Cut Off : Subdues the colors (Red, Green, Blue) on the darker parts (-31~+31).
		Red	
		Green	
		Blue	
		Cut Off	
		Red	
		Green	
		Blue	
	Reset	Reset (Available when On): Select to restore amplitude and Cut Off adjustments to default settings by pressing the  button.	
	Off	Off: Remains as default setting.	
Back Light	-20~+20	Adjusts the brightness of Back Light for maximum visibility.	
Reset		Each item in the Picture Menu can be restored to the factory setting by pressing the  button.	

SETUP OPERATION (continued)

Viewing Images from a PC (continued)

Setting Picture Adjustment (continued)

② Setup Menu

Select "Setup" from the Menu list.

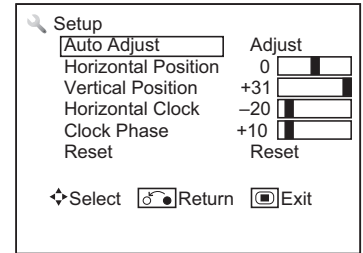

Selected Items		Setup hint
Auto Adjust		Adjusts Horizontal Position, Vertical Position, Horizontal Clock, and Clock Phase automatically. <ul style="list-style-type: none"> • Select "Adjust" then press the <input type="button" value="OK"/> button to start automatic adjustment as necessary. The message "Auto Adjusting" is displayed. • The image might not be adjusted to its optimum condition depending on the types of signals. In that case, adjust each item manually.
Horizontal Position	-63~+63	Adjusts the display position horizontally. <ul style="list-style-type: none"> • When the value exceeds a possible range, it will be displayed in magenta.
Vertical Position	-31~+31	Adjusts the display position vertically. <ul style="list-style-type: none"> • When the value exceeds a possible range, it will be displayed in magenta.
Horizontal Clock	-31~+31	Minimizes vertical stripes on the screen.
Clock Phase	0~+63	Minimizes the blurring of letters and stripes on horizontal row. <ul style="list-style-type: none"> • Be sure to adjust Horizontal Clock before adjusting Clock Phase. • When the value exceeds a possible range, it will be displayed in magenta.
Reset		Each item in Setup Menu can be restored to the factory setting by pressing the <input type="button" value="OK"/> button.

Advanced Setting

Select "Setup" from the Menu list and skip to the second page.

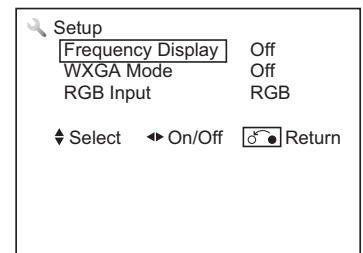

Selected Items		Setup hint
Frequency Display	Off	Set to On for PC signal frequency information to be displayed on the Input Signal Screen Display.
	On	
WXGA Mode	Off	Selects the resolution when a WXGA signal is received.
	1280X768	
	1360X768	
RGB Input	RGB	Selects the effective signal. Refer to 24 and 38 for details.
	Composite	

FUNCTION

Aspect Switching

Each time the **ASPECT** button of the remote control is pressed, the screen display aspect is switched in sequence, and the status will be displayed at the bottom of the screen.



Aspect button

HDMI/Composite Signal Input

• Display Aspect



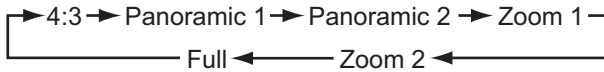

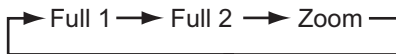

Watching Standard Definition Pictures (480i, 480p, 576i, 576p, Composite)

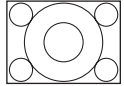
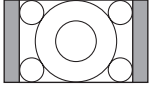
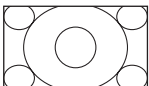

Watching High Definition Pictures (720p, 1080i, 1080p)

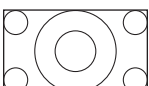

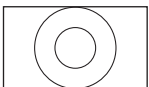
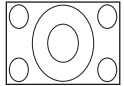
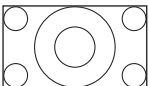
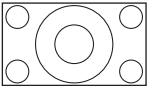
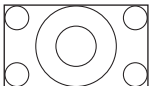
You can display the image at its optimum condition by selecting display aspect depending on the current output image as shown below.

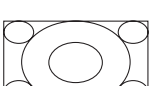
Input Signal	Display Screen	Display Aspect	To display suitable screen as follows.
When Watching Standard Definition Pictures:			
 (4:3 Signal)		4:3	Plays a 4:3 image on screen faithfully. Blanking occurs on both sides.
		Panoramic 1	Plays a 4:3 image which enlarges horizontal and vertical size of the middle in equal scales, and displays both sides appearing much wider.
		Panoramic 2	The vertical size of Panoramic1 is reduced so that you can see the whole image, including any subtitles, that might otherwise not be fully visible on the screen.
 (Vista)		Zoom 1	Plays a 16:9 image in 4:3 frame (Vista aspect) faithfully. *In some cases, slight blanking may remain at the top and bottom.
 (Cinema)		Zoom 2	Plays a 21:9 image in 4:3 frame (Cinema aspect) expanding vertically. *In some cases, slight blanking may remain at the top and bottom.
 (Squeeze)		Full	Plays a 4:3 image faithfully in the standard vertical size and horizontally squeezed.
When Watching High Definition Pictures:			
 (16:9 Signal)		Full 1	Plays a 16:9 image faithfully showing 95% of the size.
		Full 2	Plays a 16:9 image faithfully showing 100% of the size. *In some cases, the screen display has unnecessary blanking or noise at the edges.
 (4:3 Image in 16:9 Frame)		Zoom	Plays a 4:3 image in 16:9 frame by enlarging a 4:3 image to fill the 16:9 screen.



FUNCTION (continued)

Aspect Switching (continued)

HDMI/Composite Signal Input (continued)

• Position Adjustment

Vertical picture position can be adjusted for **Panoramic 1**, **Zoom 1** and **Zoom 2** mode as follows.

1. Press the  button while operating the picture aspect display.
2. "Position" display will appear.
3. Adjust the position using the  button.

The adjustment ranges of each picture aspect are as shown below.

Display Aspect	Adjustable Range
Panoramic 1	-12~+12
Zoom 1, Zoom 2	-31~+31

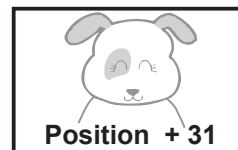

Press ▲



Press ▼

⚠ CAUTION

Using a wide-screen monitor

- The monitor has a screen mode selection feature. If an incompatible screen mode is selected to play certain software, such as a TV program, the image would appear different from the original. Take this into consideration when making screen mode choices.
- Use of the wide feature displaying enlarged pictures in coffee shops, hotel and other establishments for commercial or public viewing purposes could infringe on the copyright holder's rights, which are protected by Copyright Law.
- When a normal 4:3 image (not wide screen) is displayed over the entire screen in the Panoramic mode, the peripheral image may disappear partly and/or appear distorted in some cases. Use 4:3 mode to view the image reflecting the original intention.

RGB Signal Input

• Display Aspect

You can select a suitable aspect depending on the resolution.



* Real mode gives the image with same shapes as that of a computer monitor (neither compression nor stretching).

Display Area Selection Diagram



Resolution Display	Input signal	Full display		
		Full	Normal	Circular display Real*
640 X 480 (VGA) 800 X 600 (SVGA) 1024 X 768 (XGA) 1280 X 1024 (SXGA)				
640 X 400 (VGA) 1280 X 768 (WXGA) 1360 X 768 (WXGA)				

FUNCTION (continued)

Power Save Mode

When HDMI/Composite Input is Selected

You are provided the function to save power consumption when no signal is detected in the HDMI/Composite input. Set to On in “Video Power Save” from the Setup Menu, which leads to the power save mode.

1. Press the  button when in HDMI/Composite mode.
2. Select the “Setup” menu and press the  button.
3. Select “Video Power Save”.

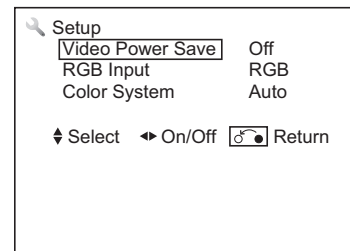



Video Power Save	Off
	On

When no signal is detected		When signal is input during On in “Video Power Save”
Condition	Indicating Lamp	
Power Save	Orange	Turns On automatically.

When RGB Input is Selected

When the unit is connected to a VESA DPMS computer, the Power Save mode (Operation mode : Off) can be set to be activated automatically when the computer is not being used, in order to reduce the power consumption of the unit.

RGB sync signal	Horizontal	Yes	No	Yes	No
	Vertical	Yes	Yes	No	No
PC signal		Active (normal display)		Blank (no display)	
Operation mode		On		Off	
Indicating lamp		Lights green		Lights orange	

- To return to operating status, operate the personal computer, or press either the **Input Select** button on the control panel or the  or  button on the remote control.

TROUBLESHOOTING

About LCD Display Technology

The following are common phenomena occurring when viewing LCD display devices due to its characteristics. Please note that these are not malfunctions.

• Defective Spots on Panel

The LCD panel is manufactured with high-precision technology. However, there might be some spots that are not illuminated, or are brighter than others, or are in different colors, etc.

• Surface on Panel

The LCD panel displays images by the fluorescent lamps internally. This can raise the temperature of the display surface.

In addition, do not allow any heavy impact to the front of the panel because the LCD panel is made of high precision glass.

• Use Under Low Temperature Conditions

Because of the structural characteristics of the LCD panel, the response speed of the LCD panel becomes slower when the ambient temperature becomes too low. In some cases, this may result in a residual image.

The residual image will disappear of its own accord as the temperature rises again to a normal level.

Before calling a service technician, check the following tables first. If the problem cannot be solved with the suggested procedures, contact **800-HITACHI**. For your safety, NEVER try to repair the product yourself.

When the Following Messages Appear on the Screen





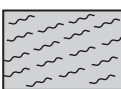



















Message	Condition / Action	Page
Power Save	This indicates it is in Power Save mode. (in HDMI/RGB mode) This message appears 5 seconds before Power Save mode starts. The indicating lamp lights in orange.	42
No Sync. Signal	The unit cannot detect any signals from any input terminals. <ul style="list-style-type: none"> • Check if the cable is connected correctly and firmly. • Check if the power of any external equipment is ON. • Check if the input selection matches the connection terminal. • Check if the PC is in Power Save mode or not. 	18 ~ 21 42
Invalid Scan Freq.	The unit receives unsupported signals. <ul style="list-style-type: none"> • Check if the cable is connected correctly and firmly. • Check if the input signal is compatible with the specification of the monitor. 	46, 48
Not Available	This shows when the selected operation is not available.	
Auto Adjusting	This indicates that it is in the process of auto adjusting. (in RGB mode)	39

Symptom and Checklist

Symptoms		Checklist	Page
• No picture - no sound		<ul style="list-style-type: none"> • Ensure the Main Switch is On. • Check the Indicating lamp status (Off, Red, Green, or Orange). • Check the connection of the power cord and/or other cables. • Check if the power of the unit or external equipment is ON. • Check if the correct mode is selected. • Check if the unit is in "Standby mode" or "Power Save mode". • Adjust the values in "Picture menu" and "Audio menu". 	18 ~ 22 24, 44
• Multiple images-normal sound		<ul style="list-style-type: none"> • Check the connections to external equipment. 	18 ~ 21
• Intermittent interference		<ul style="list-style-type: none"> • Check if the source of interference is shielded correctly. • Move these kinds of electrical devices away from the unit. 	







TROUBLESHOOTING (continued)

Symptom and Checklist (continued)

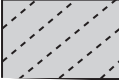
Symptoms	Checklist	Page
<ul style="list-style-type: none"> • Normal picture, but no sound 	<ul style="list-style-type: none"> • Check the volume level. • Check audio settings on HDMI source must be set to PCM. • Check if the  button has been pressed or not. • Check the connections to external equipment. • Check if input signal is HDMI or DVI by pressing  button, remember DVI audio must be input by separate. 	<p> 23</p>
<ul style="list-style-type: none"> • No picture - normal sound 	<ul style="list-style-type: none"> • Check the value level of "Brightness" and "Contrast" in "Picture Menu". 	<p> 33,  38</p>
<ul style="list-style-type: none"> • The remote control does not work. 	<ul style="list-style-type: none"> • Check if the batteries are installed correctly. • The batteries might be exhausted. Replace them with new ones. • Remove all obstructions from in front of the sensor window on the unit. • Check if the buttons on the control panel are working. 	<p> 16,  17</p>
<ul style="list-style-type: none"> • Only some buttons work on the remote control. 	<ul style="list-style-type: none"> • This is normal, some buttons are intended to use with optional Hitachi Set-Top Box 	<p> 16</p>
<ul style="list-style-type: none"> • Picture Freeze and/or the buttons on both the remote control and control panel do not work. 	<ul style="list-style-type: none"> • Unplug and connect after 5 minutes the power cord or turn Main switch Off and On after 5 minutes. • Hold down the Reset button on the control panel for over a second. 	<p> 15</p>
<ul style="list-style-type: none"> • Normal picture but no color-normal sound 	<ul style="list-style-type: none"> • Check the connections to external equipment. 	<p> 18 ~  21</p>
<ul style="list-style-type: none"> • No picture The Indicating lamp → Off 	<ul style="list-style-type: none"> • Check if the power cord is plugged into the socket securely. • Check if the main switch is on. 	<p> 21,  22</p>
<ul style="list-style-type: none"> • No picture The Indicating lamp → Orange It means that the unit is in "Power Save mode". 	<ul style="list-style-type: none"> • Check if all the cables to external equipment are connected correctly and securely. • Check if the power to the external equipment is ON. • Check if the HDMI mode has been selected correctly. • Check if the PC is in Power Save mode or not. • Refer to "Power Save Mode" and "When the Following Messages Appears on the Screen". 	<p> 42</p>
<ul style="list-style-type: none"> • No picture The indicating lamp → Green 	<ul style="list-style-type: none"> • Check if the signal cable is connected correctly and securely. • Adjust the level of Brightness and Contrast lower. 	<p> 18 ~  21</p>
<ul style="list-style-type: none"> • The top of the unit and surface of the panel heat up. 	<ul style="list-style-type: none"> • This may occur if you use the unit for a long time. Turn off the main power to the unit for a while. Please note that this is not a malfunction. 	
<ul style="list-style-type: none"> • Some screen display aspects are not possible. 	<ul style="list-style-type: none"> • Check the signal status by pressing the  button on the remote control. The available screen display aspect is different depending on the current signal status. 	<p> 24  40,  41</p>
<ul style="list-style-type: none"> • Image cannot be displayed from HDMI input. 	<ul style="list-style-type: none"> • Check if the cables are connected correctly. • Turn off Monitor and HDMI source, then turn Monitor on first then HDMI source. • Check the output format of the equipment. • (Please refer to "CONNECTION" and "Recommended Signal List".) 	<p> 46 ~  48</p>
<ul style="list-style-type: none"> • The image and audio are mismatched when in RGB or HDMI-DVI mode. 	<ul style="list-style-type: none"> • Check if the PC (RGB)/DVI analog audio input terminal is connected to the same external device. 	<p> 18,  20</p>
<ul style="list-style-type: none"> • Some digital programming looks blurry during fast changing scenes.. 	<ul style="list-style-type: none"> • This is normal and its due regular digital compression scheme, please note this is not a malfunction. 	

TROUBLESHOOTING (continued)

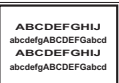
Symptom and Checklist (continued)

Symptoms		Checklist	Page
<ul style="list-style-type: none"> The image on the screen is moving in an oblique direction. (RGB input mode only) 		<ul style="list-style-type: none"> Adjust "Horizontal Clock" and "Clock Phase". 	39
<ul style="list-style-type: none"> The coarse vertical stripes can be seen in full-display mode. (RGB input mode only) 		<ul style="list-style-type: none"> Adjust "Horizontal Clock". 	39
<ul style="list-style-type: none"> Part of the image is missing. (RGB input mode only) 		<ul style="list-style-type: none"> Try "Auto Adjust". 	39
<ul style="list-style-type: none"> The horizontal stripes are moving vertically with flickering screen. (RGB input mode only) 		<ul style="list-style-type: none"> Check the signal status of the PC by pressing the  button on the remote control to check if the input signal of the displayed image is compatible with the specification of the unit. 	24, 46 48
<ul style="list-style-type: none"> When the characters are displayed on the whole screen, the vertical stripes appear and some of the characters are blurred. (RGB input mode only) 		<ul style="list-style-type: none"> Try "Auto Adjust". If the display condition is not improved with "Auto Adjust", adjust "Horizontal Clock". 	39
<ul style="list-style-type: none"> When the letter string is displayed in full-screen, all of the characters on the screen are blurred. (RGB input mode only) 		<ul style="list-style-type: none"> Try "Auto Adjust". If the condition is not improved with "Auto Adjust", adjust "Clock Phase" until you get the clearest image. 	39
<ul style="list-style-type: none"> When small patterns are displayed on the screen, the entire screen is flickering. (RGB input mode only) 		<ul style="list-style-type: none"> Try "Auto Adjust". If the condition is not improved with "Auto Adjust", adjust "Clock Phase" until you get a flicker-free display. 	39
<ul style="list-style-type: none"> Image cannot be displayed in the correct position. (RGB input mode only) 		<ul style="list-style-type: none"> Press the  button to check if the input signal of the displayed image is compatible with the specification of the unit. 	24, 46 48

PRODUCT SPECIFICATIONS

SPECIFICATION			
Panel	Display dimensions	Approx. 37 inches measured diagonal (32 5/16 (H) x 18 1/8 (V) in) Approx. 941 mm measured diagonal (820 (H) x 461 (V) mm)	Approx. 42 inches measured diagonal (36 3/4 (H) x 20 3/4 (V) in) Approx. 1068 mm measured diagonal (931 (H) x 524 (V) mm)
	Resolution	1920 (H) x 1080 (V) pixels	1920 (H) x 1080 (V) pixels
	Pixel Pitch	0.43(H) x 0.43(V) mm.	0.48(H) x 0.48(V) mm.
Net dimensions		including Stand: 936(W)x657(H)x310(D) mm 36 7/8(W) x 25 7/8(H) x 12 3/16(D) in excluding Stand: 936(W)x607(H)x40(D) mm 36 7/8(W) x 23 7/8(H) x 1 9/16(D) in	including Stand: 1037(W) x 728(H) x 310(D) mm 40 13/16(W) x 28 11/16(H) x 12 3/16(D) in excluding Stand: 1037(W) x 678(H) x 40(D) mm 40 13/16(W) x 26 11/16(H) x 1 9/16(D) in
Net weight		including Stand: 17.4 kg/38.3 lb excluding Stand: 14.6 kg/32.2 lb	including Stand: 20.9 kg/46.1 lb excluding Stand: 18 kg/39.7 lb
Ambient conditions	Temperature	Operating : 5°C to 35°C, Storage : 0°C to 40°C	
	Relative humidity	Operating : 20% to 80%, Storage : 20% to 90% (non-condensing)	
Power supply		AC120V, 60Hz	
Power consumption/ at standby		177 W, 1.7 A/< 0.5 W	243 W, 2.3 A/< 0.5 W
Audio output		speaker 6W + 6W	
FCC Class		B for Consumer Use	
(HDMI input)			
Input terminals		HDMI : HDMI input terminal Audio input terminal (Mini-pin)*	
Input signals		HDMI: VGA/60, 480i, 576i, 480p, 576p, 720p/50, 720p/60, 1080i/50, 1080i/60, 1080p/50, 1080p/60, 1080p/24	
(RGB/Composite input)			
Input terminals		Analog RGB input terminal (D-sub 15 pin) Audio input terminal (Mini-pin)*	
Input signals		0.7 Vp-p, analog RGB (Recommended Signal) Composite video: PAL, SECAM, NTSC3.58, NTSC4.43, PAL60, PAL-M, PAL-N	
Sync signals		H/V separate, TTL level [2KΩ]	

• The unit takes at least 30 minutes to attain the status of optimal picture quality.

* This analog audio input terminal can be used for PC (RGB) or HDMI-DVI.

PRODUCT SPECIFICATIONS (continued)

Signal Input

RGB terminal (D-sub 15 pin connector)

Pin	Input signal
1	R
2	G/Composite
3	B
4	No connection
5	GND
6	R.GND
7	G.GND/Composite
8	B.GND
9	+5V
10	GND
11	No connection
12	[SDA]
13	H.sync
14	V.sync.
15	[SCL]

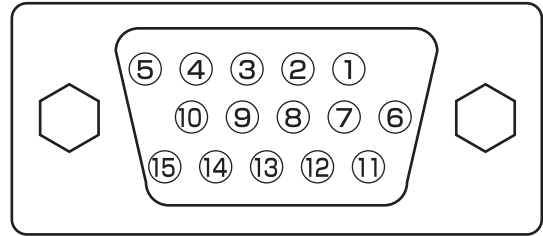

HDMI connector pin specifications

Pin	Input signal	Pin	Input signal
1	TMDS Data2+	11	TMDS Clock Shield
2	TMDS Data2 Shield	12	TMDS Clock-
3	TMDS Data2-	13	CEC
4	TMDS Data1+	14	Reserved(N.C. on device)
5	TMDS Data1 Shield	15	SCL
6	TMDS Data1-	16	SDA
7	TMDS Data0+	17	DDC/CEC Ground
8	TMDS Data0 Shield	18	+5V Power
9	TMDS Data0-	19	Hot Plug Detect
10	TMDS Clock+		

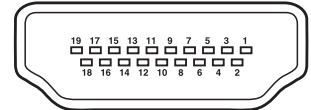

PRODUCT SPECIFICATIONS (continued)

Recommended Signal List

With HDMI input

No.	Signal mode			Horizontal frequency (kHz)	Dot clock frequency (MHz)	Remarks
	Signal Name	Resolution	Vertical frequency (Hz)			
1	VGA	640 X 480	59.94	31.47	25.18	CEA-861D
2	576i	720(1440) X 576	50.00	15.63	27.00	CEA-861D
3	480i	720(1440) X 480	59.94	15.73	27.00	CEA-861D
4	576p	720 X 576	50.00	31.25	27.00	CEA-861D
5	480p	720 X 480	59.94	31.47	27.00	CEA-861D
6	1080i/50	1920 X 1080	50.00	28.13	74.25	CEA-861D
7	1080i/60	1920 X 1080	60.00	33.75	74.25	CEA-861D
8	720p/50	1280 X 720	50.00	37.50	74.25	CEA-861D
9	720p/60	1280 X 720	60.00	45.00	74.25	CEA-861D
10	1080p/50	1920 X 1080	50.00	56.25	148.50	CEA-861D
11	1080p/60	1920 X 1080	60.00	67.50	148.50	CEA-861D
12	1080p/24	1920 X 1080	24.00	27.00	74.25	CEA-861D

With RGB input

Timing Name	Horizontal Frequency (kHz)	Vertical Frequency (Hz)	Pixel Frequency (MHz)	Sync Polarity (H/V)	Remarks
640 x 400 @ 70Hz	31.469	70.086	25.175	- / +	VGA
640 x 480 @ 60Hz	31.469	59.940	25.175	- / -	VGA
800 x 600 @ 60Hz	37.879	60.317	40.000	+ / +	VESA
1024 x 768 @ 60Hz	48.363	60.004	65.000	- / -	VESA
1280 x 768 @ 60Hz	47.776	59.870	79.500	- / +	VESA / WXGA Mode : 1280x768
1280 x 1024 @ 60Hz	63.981	60.020	108.00	+ / +	VESA
1360 x 768 @ 60Hz	47.712	60.015	85.500	+ / +	VESA / WXGA Mode : 1360x768

- The type of video board or the connecting cable used may not allow for correct displays adjustment of Horizontal Position, Vertical Position, Horizontal Clock and Clock Phase.
- The unit differentiates the signal modes according to the horizontal and vertical frequencies and the horizontal and vertical sync signal polarities. Note that different signals having all these elements alike may be handled as the same signal.

PRODUCT SPECIFICATIONS (continued)

Dimensions 37"

Unit: Inch/(mm)

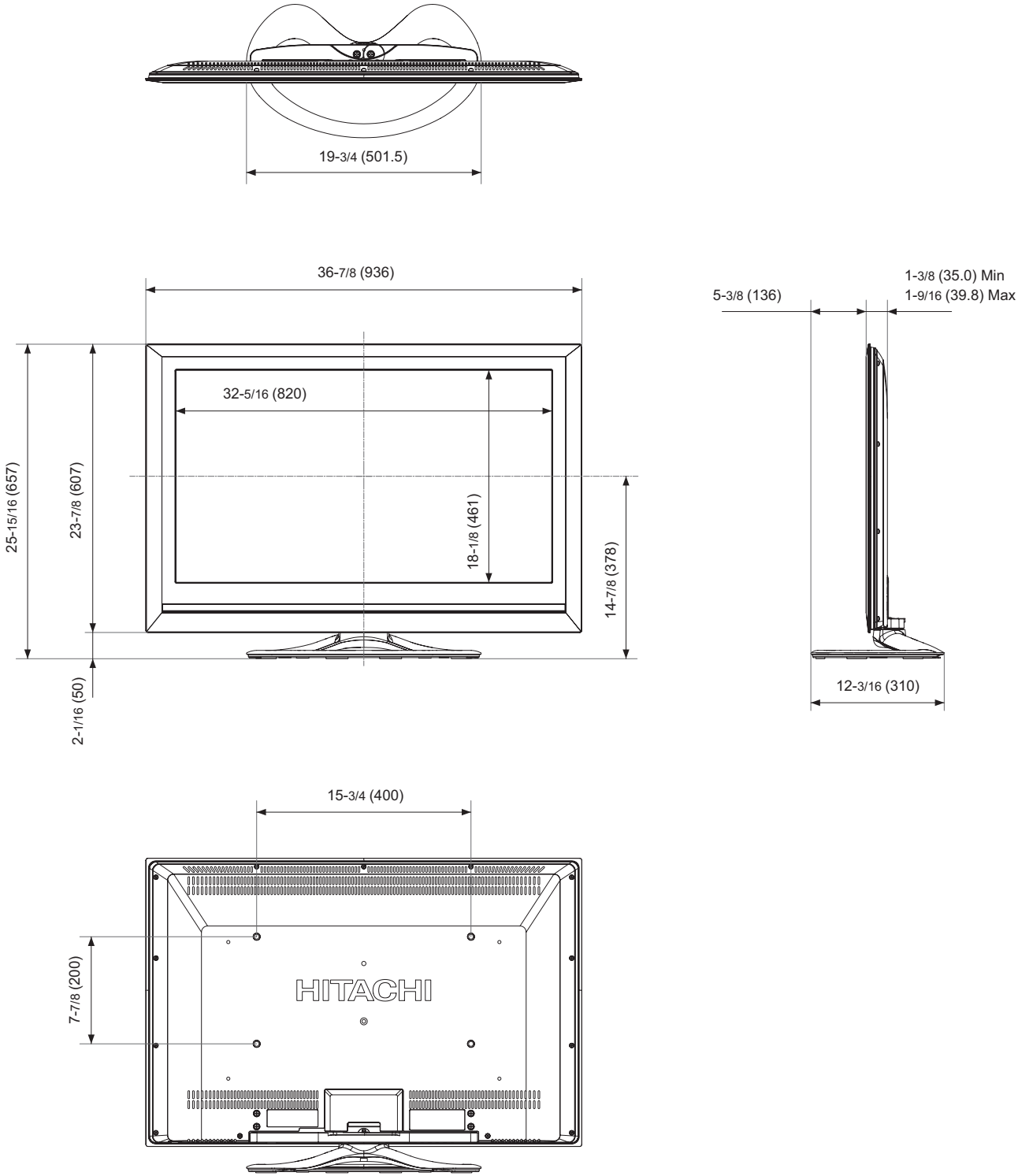

PRODUCT SPECIFICATIONS (continued)

Dimensions 42"

Unit: Inch/(mm)

ENGLISH

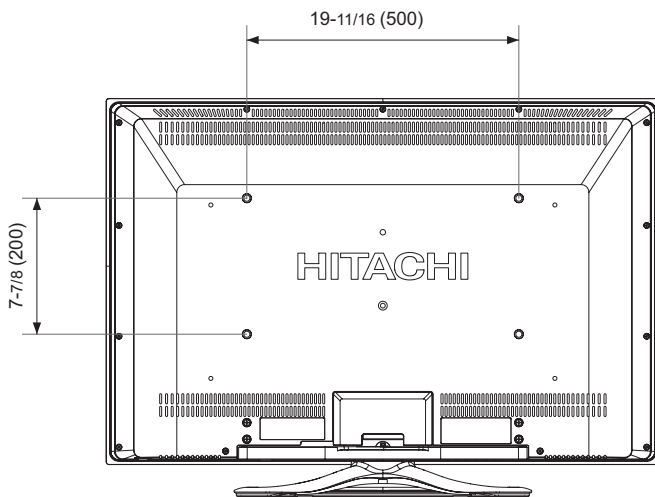
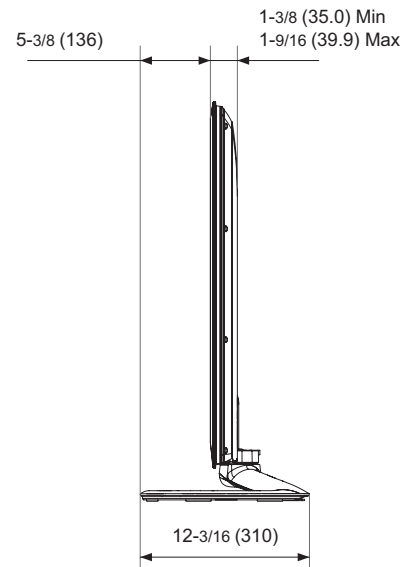
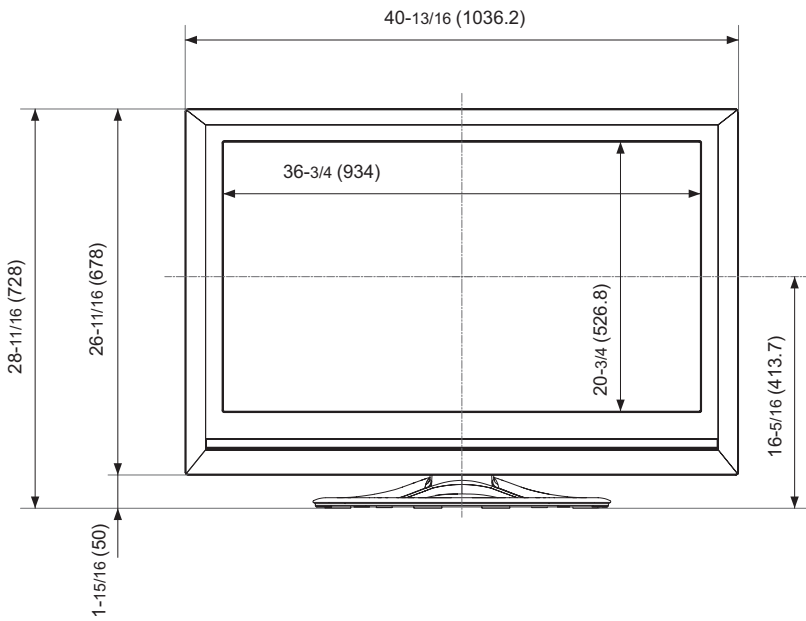
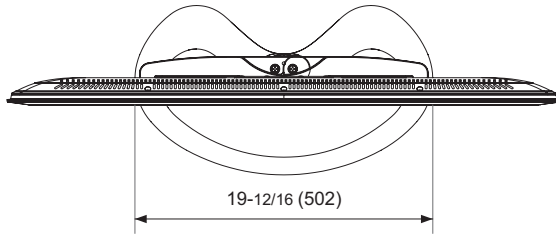

SERVICE INFORMATION

800.HITACHI
(800.448.2244)

Operational, hook up and warranty questions for your product.

Monday ~ Sunday
8:00 am - 8:30 pm CST

www.hitachi.us/tv



Sincere - Prompt - Efficient

HITACHI
Inspire the Next

HITACHI HOME ELECTRONICS (AMERICA), INC.

HITACHI has made every effort to assure you hours of trouble free operation from your Hitachi product. Should you require service assistance with **OPERATIONAL, HOOK UP, TECHNICAL ASSISTANCE OR WARRANTY SUPPORT**, please contact our Support Hotline at **800.HITACHI (800.448.2244)**.

Our Support Hotline will provide you with the assistance you need and if necessary the location of the nearest Authorized Service Facility in your area. Please present proof of purchase and/or delivery receipts to the Hitachi Authorized Service Facility and service will be rendered in accordance with the terms of the limited warranty as stated on your warranty card or operating guide.

**Hitachi Home Electronics
(America), Inc.**
Customer Service Support
PO Box 3900
Peoria, IL 61612
customerservice.ce@hea.hitachi.com

HITACHI HOME ELECTRONICS (CANADA)

Should you have any questions regarding warranty, service, operation or technical assistance, please contact:

In Canada: 800.HITACHI (800.448.2244)
Monday~ Friday 9:00 am – 7:00 pm EST
Saturday 9:00 am – 5:00 pm EST

Look for your French Manual on the outside of the box. If manual is missing, call **800-HITACHI** for a copy.

Pour de plus amples renseignements sur le service durant la période couverte par la garantie, sur le fonctionnement ou pour de l'assistance technique communiquez avec:

Au Canada: 800.HITACHI (800.448.2244)
Lundi~ Vendredi 9:00 am – 7:00 pm L'EST
Samedi 9:00 am – 5:00 pm L'EST

La version française de votre manuel se trouve à l'extérieur de la boîte. Si le manuel est manquant coposez le **800-HITACHI** pour obtenir votre copie

Hitachi Home Electronics (Canada)
Customer Service Support
PO Box 3900
Peoria, IL 61612

Customer Record

The MODEL NAME and SERIAL NUMBER of this product is located on the backcover and also on the RIGHT SIDE of the set. Please follow the next steps to find this information and then record it in the space provided below for use in case you call 800.HITACHI, they will require this information in order to give you the proper support.

- ① Look on the right side of the set
- ② Locate the label where it shows the information related to MODEL NAME and SERIAL #.
- ③ 800.HITACHI will require this information in order to give you the proper support regarding your questions.

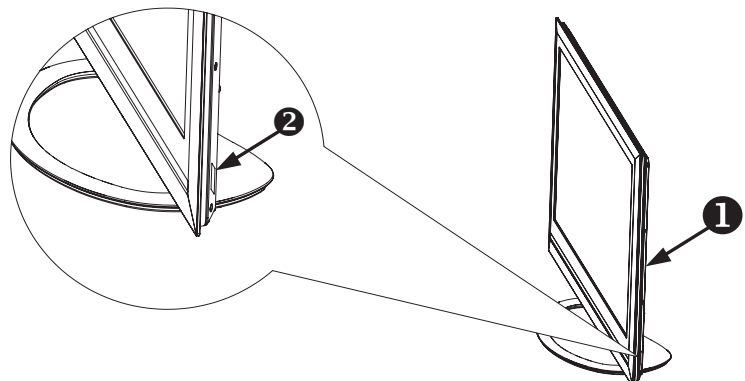

Model Name _____

Serial Number _____

LIMITED WARRANTY

Congratulations on your purchase of a new Hitachi display product.
 Register your product online at www.hitachi.us/tv or mail the included warranty registration card:

LIMITED WARRANTY
 Hitachi Home Electronics (America), Inc. warrants this product in accordance with the terms and conditions applicable to the Products identified below:

Conditions of Hitachi Limited Warranty
 This Hitachi display product (the "Product") is warranted to be free from defects in materials and workmanship beginning on the date of purchase by the original owner and continuing for the duration of the applicable time periods specified below. If the Product is found to be defective, Hitachi will repair or replace (at Hitachi's option) defective parts at no charge, subject to the conditions of this Limited Warranty. If the original owner rejects, refuses or otherwise does not accept Hitachi's offer to repair or replace such defective parts under this Limited Warranty, this Limited Warranty shall be void and of no further force or effect. This Limited Warranty extends to the original owner only and is not transferable, and such owner must provide a dated sales receipt for the Product to qualify for parts or service under this Limited Warranty. The original owner must notify Hitachi of a defect claim during the applicable Limited Warranty period for this Limited Warranty to be effective. This Limited Warranty is valid only in the U.S.A. and Puerto Rico.

LCD Flat Panel Televisions
 LCD Flat Panel Monitors
 Plasma Televisions
 Plasma Monitors

PARTS: The Limited Warranty period for parts is 2 years from the date of original purchase. During the Limited Warranty period for parts, Hitachi will replace defective parts with new or rebuilt parts (at Hitachi's option) at no charge for such parts. Any replacement part will be warranted for the remainder of the original warranty period applicable to the part replaced.

LABOR: The Limited Warranty period for labor is 2 years from the date of original purchase. During the Limited Warranty period for labor, Hitachi will repair or replace (at Hitachi's option) defective parts without charge for labor.

SERVICE LOCATION: In-home warranty service, which includes either in-home repair or free pick-up and delivery (at Hitachi's option), applies to all Hitachi Products except: (i) 26-inch and smaller LCD Flat Panel Televisions or LCD Flat Panel Monitors; (ii) Products located outside the U.S.A. or Puerto Rico; (iii) Products located more than seventy-five (75) driving miles from Hitachi's nearest Authorized Service Facility. If the foregoing clauses (i), (ii), (iii) apply, then the Product owner will be responsible for bringing/delivering the Product to a Hitachi Authorized Service Facility and, following warranty service, retrieving the Product from such Authorized Service Facility.



Hitachi is a proud supporter of the Certified Service Center program. Businesses who display the CSC certification mark have demonstrated that they operate in accordance with the high standards of professionalism prescribed by the Consortium for Certified Service Centers.

800-HITACHI (800-448-2244)

Please call 800-HITACHI (800-448-2244) for operational, hook up, warranty questions or the location of your nearest Hitachi Authorized Service Facility or Parts Distributor.

Visit our website and register your product online:

Hitachi's website features a wealth of information on Hitachi products and technologies, as well as downloadable operating guides and other useful information.

To register your new Hitachi display product online, go to:
www.hitachi.us/tv Support and Contact/Warranty Registration

IMPORTANT:

Before using or installing your Product, please complete this form and attach your sales receipt and retain them for your records. This will help facilitate proper warranty coverage.

MODEL NO.	SERIAL NO.
DEALER NAME	DATE OF PURCHASE
DEALER ADDRESS	
CITY	STATE

Warranty Limitations

This Hitachi Limited Warranty does not cover:

- A. Any Product that has been modified or repaired in a manner not previously authorized by Hitachi in writing.
- B. Any Product whose serial number has been removed, altered, replaced, defaced or rendered illegible.
- C. Any defect, malfunction, or failure caused by or resulting from improper or unauthorized service, maintenance or repair.
- D. Damage resulting from abuse, misuse, mishandling, neglect or damage caused by exposure to hostile operating environments such as areas containing dust and/or smoke.
- E. Damage caused by power surges, accidents, natural disasters or any other events or circumstances outside Hitachi's control.
- F. Any Product used in any manner inconsistent with the acceptable set-up, usage, safety or installation configurations identified in the Product's Operating Guide.
- G. Any Product used for purposes or applications, or subjected to operating conditions, other than those identified as acceptable in the Product's Operating Guide.
- H. Product repairs (including any product whose case has been opened), or part replacements provided or installed, by any person other than an Authorized Hitachi Service Facility Representative.
- I. Improper uncrating, set-up or installation or any misadjustments caused by user-operated controls.
- J. Any labor or costs associated with removing the Product from a custom cabinet or other specialized product installation that impedes direct and immediate removal of the Product from the owner's premises (must be arranged and paid by the owner).
- K. Product cabinets, cabinet parts, knobs, batteries or accessories.
- L. Product screens that have been cleaned by any method other than as specified in the Product's Operating Guide.
- M. Normal usage, degraded brightness caused by backlight aging and/or cell defects or ordinary wear and tear, including, without limitation, scratches or marks on the Product's screen, cabinet or the appearance of bright or dark screen pixels.
- N. Any Product returned for service that is damaged due to improper packaging, mishandling or shipping. (IMPORTANT: When shipping any Product to a Hitachi Authorized Service Centers, Product owner must package it securely in the original shipping container or its equivalent to prevent damage. The Product must be returned with the shipping charges prepaid and proof of purchases included in the shipping container. Failure to properly package such product during such shipment will void all warranties.)
- O. Any Product purchased or serviced outside the United States of America and Puerto Rico.
- P. Any Product that has been used for commercial purposes.

NO PERSON, AGENT, DISTRIBUTOR, DEALER, SERVICE FACILITY, OR COMPANY IS AUTHORIZED TO CHANGE, MODIFY OR AMEND THE TERMS OF THIS LIMITED WARRANTY IN ANY MANNER WHATSOEVER. EXCEPT AS PROVIDED IN THIS LIMITED WARRANTY, HITACHI MAKES NO EXPRESS WARRANTY REGARDING THIS HITACHI PRODUCT. FURTHER, ALL IMPLIED WARRANTIES RELATING TO ANY PORTION OF THIS PRODUCT, INCLUDING ANY WARRANTY OF MERCHANTABILITY OR FITNESS FOR A PARTICULAR PURPOSE, ARE LIMITED TO THE DURATION SPECIFIED UNDER THIS LIMITED WARRANTY. HITACHI SHALL NOT BE LIABLE TO THE PURCHASER OR TO ANY OTHER PERSON FOR ANY INCIDENTAL OR CONSEQUENTIAL DAMAGES OR LOSS OF PROFIT OR PRODUCT RESULTING FROM ANY DEFECT IN, OR MALFUNCTION OR FAILURE OF, THIS HITACHI PRODUCT. BECAUSE SOME STATES DO NOT ALLOW LIMITATIONS ON HOW LONG AN IMPLIED WARRANTY LASTS, OR THE EXCLUSION OF INCIDENTAL OR CONSEQUENTIAL DAMAGES, THE ABOVE LIMITATIONS MAY NOT APPLY TO YOU. THIS LIMITED WARRANTY CONFERS SPECIFIC LEGAL RIGHTS, INCLUDING CERTAIN OTHER RIGHTS THAT MAY VARY DEPENDING ON YOUR JURISDICTION.

END USER LICENSE AGREEMENT FOR HITACHI SOFTWARE

END USER LICENSE AGREEMENT FOR HITACHI SOFTWARE

IMPORTANT – READ CAREFULLY: This End User License Agreement for **HITACHI** Software (this “Agreement”) is a legal agreement between you (“you” or “your”), in your capacity as the owner of a **HITACHI** brand display product (the “Product”), and **HITACHI** Home Electronics (America), Inc. (“**HITACHI**”). By using the Product or the **HITACHI** software installed on the Product (the “**HITACHI** Software”) or any Upgrade (as defined below, and together with the **HITACHI** Software, the “Software”), you agree to be bound by the terms and conditions of this Agreement. IF YOU DO NOT AGREE TO BE BOUND BY THIS LICENSE AGREEMENT, DO NOT USE THE PRODUCT OR THE SOFTWARE.

- LICENSE GRANT.** **HITACHI** grants to you, for the life of the Product, a non-exclusive, non-transferable, revocable license to install and use one copy of the Software on the Product, subject to the following limitations and restrictions:
 - You may not share, duplicate, republish or redistribute the Software;
 - You may not resell, rent, lease, sublicense, gift, loan, as sign or otherwise transfer the Software or any of your rights under this Agreement;
 - You may not modify, adapt, translate, reverse engineer, decompile, disassemble or make derivative works from the Software or use the Software in combination with any non-Hitachi software; and
 - You may not use the Software for any commercial purpose.
- VIOLATIONS; INDEMNITY.** You understand and agree that your use of the Software in any manner except as permitted under this Agreement could constitute a serious crime and could subject you to damages and an award to **HITACHI** of attorneys’ fees in connection with your violation of this Agreement. You further understand that you may be held legally responsible for any copyright infringement or other violation of intellectual property rights caused or facilitated by your failure to abide by the terms of this Agreement. You agree to defend, indemnify and hold **HITACHI** and its parent and affiliate companies harmless from and against any and all liability resulting from any breach by you of this Agreement.
- INTELLECTUAL PROPERTY.** The Software is protected by federal copyright laws, international copyright treaties and other intellectual property laws and treaties. The Software is licensed, not sold, to you. All right, title and interest in and to the Software and any intellectual property associated therewith, including any accompanying printed materials, shall belong to **HITACHI** and its licensors and suppliers. Except as expressly provided herein, neither **HITACHI** nor any of its licensors or suppliers grants to you under this Agreement any express or implied right in or to any patents, copyrights, trademarks, trade secrets or other intellectual property. All right, title and interest in and to the intellectual property rights associated with any content that is accessible through use of the Software shall belong to the applicable content owners and may be protected by copyright or other intellectual property laws and treaties. This Agreement grants you no rights to use such content. Any rights of **HITACHI** not expressly granted to you hereunder are reserved expressly by Hitachi.
- SOFTWARE UPGRADES.** In the future, **HITACHI** may release or make available one or more upgrades to the **HITACHI** Software (each, an “Upgrade”). You understand and agree that if you decide to install or use any Upgrade, your installation and use of such Upgrade and/or any other software or intellectual property **HITACHI** may provide in connection therewith shall be governed by the terms and conditions of this Agreement, except to the extent that **HITACHI** provides different or supplementary license terms or conditions that accompany such Upgrade or other software or intellectual property. In the event **HITACHI** provides you with a “flash card” or other media to effect or facilitate an Upgrade, you understand and acknowledge that your failure to return such flash card or other media to **HITACHI** as **HITACHI** may require could result in **HITACHI** placing your name and your Product’s serial number on a “No Further Upgrades” list, which will prohibit you from receiving any subsequent Upgrades **HITACHI** may later release or make available. IF YOU DO NOT AGREE WITH ALL THE TERMS AND CONDITIONS OF THIS AGREEMENT OR ALL THE TERMS AND CONDITIONS OF ANY DIFFERENT OR SUPPLEMENTARY LICENSE THAT MAY ACCOMPANY SUCH UPGRADE, (A) DO NOT USE ANY **HITACHI**-PROVIDED FLASH CARD OR OTHER MEDIA, (B) DO NOT PERFORM INSTALL ANY **HITACHI**-PROVIDED UPGRADE SOFTWARE ON YOUR PRODUCT, AND (C) PROMPTLY RETURN SUCH FLASH CARD OR OTHER MEDIA TO **HITACHI**.
- EXPORT RESTRICTIONS.** **HITACHI** is licensing the Software for use within North America only. You agree that you will not export or re-export the Software. You specifically agree not to export or reexport the Software: (i) to any country to which the U.S. has embargoed or restricted the export of goods or services, which currently include, but are not necessarily limited to Cuba, Iran, Libya, North Korea, Sudan and Syria, or to any national of any such country, wherever located, who intends to transmit or transport the Software back to such country; (ii) to any person or entity who you know or have reason to know will utilize the Software in the design, development, or production of nuclear, chemical, or biological weapons; or (iii) to any person or entity who has been prohibited from participating in U.S. export transactions by any federal agency of the U.S. government. You warrant and represent that neither the U.S. Bureau of Industry and Security nor any other U.S. federal Agency has suspended, revoked, or denied your export privileges.
- NO WARRANTIES.** The software is provided to you in “as is” condition and **HITACHI** makes no warranties of any kind whatsoever regarding the software and, to the maximum extent permitted by law, hereby expressly disclaims all warranties of any kind whatsoever, express or implied, with respect to the software. All implied warranties, including without limitation, the implied warranties of non-infringement, merchantability and fitness for a particular purpose are hereby expressly disclaimed by **HITACHI** to the maximum extent permitted by law.
- LIMITATION OF LIABILITY.** To the maximum extent permitted by applicable law, **HITACHI**, its licensors, suppliers, parent companies, affiliates, subsidiaries, employees and agents shall not under any circumstances be liable to you or any third parties for any damages of any nature arising in any way from this agreement, your use of the software or otherwise, whether indirect, special, incidental, consequential or otherwise, including, without limitation, any claims for lost profits, lost good will, lost data, business interruption, procurement of substitute goods or services, or expenditures made or committed for in reliance on the continuation of this agreement, even if advised in advance of the possibility of such damages.
- NO FAILURE OF ESSENTIAL PURPOSE.** You agree that neither **HITACHI**’s breach of this agreement nor its failure to repair a defect, error or bug in the software shall constitute a failure of the essential purpose of this agreement.
- CRYPTOGRAPHIC SOFTWARE.** The software contains software developed by the OpenSSL Project, including cryptographic software written by Eric Young (the “cryptographic software”). The cryptographic software is provided by the OpenSSL Project in “as is” condition and any express or implied warranties, including but not limited to, the implied warranties of merchantability and fitness for a particular purpose are hereby expressly disclaimed to the maximum extent permitted by law. In no event shall the OpenSSL Project, its contributors, **HITACHI** or any of its parent or affiliate companies be liable for any direct, indirect, incidental, special, exemplary, or consequential damages (including, but not limited to, procurement of substitute goods or services; loss of use, data, or profits; or business interruption) however caused and on any theory of liability, whether in contract, strict liability, or tort (including negligence or otherwise) arising in any way out of the use of the software or the cryptographic software, even if advised in advance of the possibility of such damages.
- TERMINATION.** **HITACHI** may terminate this Agreement immediately at any time by providing notice to you.
- GOVERNING LAW; SEVERABILITY.** This Agreement will be governed by the laws of the State of New York, and you consent to the exclusive jurisdiction and venue in the federal courts sitting in the Southern District of New York, unless no federal subject matter jurisdiction exists, in which case you consent to the exclusive jurisdiction and venue in the Borough of Manhattan, New York, USA.