

# MINOLTA

The essentials of imaging

[www.minolta.com](http://www.minolta.com)



## ***DIMAGE*** **E223**

**E** INSTRUCTION MANUAL

## Before you begin

Thank you for purchasing this Minolta digital camera. Please take the time to read through this instruction manual so you can enjoy all the features of your new camera.

Check the packing list before using this product. If any items are missing, immediately contact your camera dealer.

Minolta DiMAGE E223 digital camera  
AA alkaline batteries (set of two)  
Hand strap HS-DG223  
Video cable VIC-100  
USB cable USB-700  
DiMAGE Viewer CD-ROM  
DiMAGE E223 instruction manual  
DiMAGE Viewer instruction manual  
Warranty card

Because the performance of alkaline batteries with digital cameras is low, the use of Ni-MH batteries or a CR-V3 lithium battery is recommended.

Apple, Macintosh, and Mac OS are registered trademarks of Apple Computer Inc. Microsoft and Windows are registered trademarks of the Microsoft Corporation. The official name of Windows is Microsoft Windows Operating System. Pentium is a registered trademark of the Intel Corporation. QuickTime is a trademark used under license. All other trademarks are the property of their respective owners.

## For proper and safe use

Read and understand all warnings and cautions before using this product.

### WARNING

Using batteries improperly can cause them to leak harmful solutions, overheat, or explode which may damage property or cause personal injury. Do not ignore the following warnings.

- Only use the batteries specified in this instruction manual.
  - Do not install the batteries with the polarity (+/-) reversed.
  - Do not use batteries which show wear or damage.
  - Do not expose batteries to fire, high temperatures, water, or moisture.
  - Do not attempt to short or disassemble batteries.
  - Do not store batteries near or in metallic products.
  - Do not mix batteries of different types, brands, ages, or charge levels.
  - Do not charge alkaline or lithium batteries.
  - When recharging rechargeable batteries, only use the recommended charger.
  - Do not use leaking batteries. If fluid from the batteries enters your eye, immediately rinse the eye with plenty of fresh water and contact a doctor. If fluid from the batteries makes contact with your skin or clothing, wash the area thoroughly with water.
  - Tape over battery contacts to avoid short-circuiting during disposal; always follow local regulations for battery disposal.
- 
- Use only the specified AC adapter within the voltage range indicated on the adapter unit. An inappropriate adapter or current may cause damage or injury through fire or electric shock.
  - Do not disassemble this product. Electric shock may cause injury if a high voltage circuit inside the product is touched.
  - Immediately remove the batteries or unplug the AC adapter and discontinue use if the camera is dropped or subjected to an impact in which the interior, especially the flash unit, is exposed. The flash has a high voltage circuit which may cause an electric shock resulting in injury. The continued use of a damaged product or part may cause injuries or fire.

- Keep batteries or small parts that could be swallowed away from infants. Contact a doctor immediately if an object is swallowed.
- Store this product out of reach of children. Be careful when around children not to harm them with the product or parts.
- Do not fire the flash directly into the eyes. It may damage eyesight.
- Do not fire the flash at vehicle operators. It may cause a distraction or temporary blindness which may lead to an accident.
- Do not use the monitor while operating a vehicle or walking. It may result in injury or an accident.
- Do not look directly at the sun or strong light sources through the viewfinder. It may damage your eyesight or cause blindness.
- Do not use this product in a humid environment, or operate this product with wet hands. If liquid enters the product, immediately remove the batteries or unplug the AC adapter and discontinue use. The continued use of a product exposed to liquids may cause damage or injury through fire or electric shock.
- Do not use the product near inflammable gases or liquids such as gasoline, benzene, or paint thinner. Do not use inflammable products such as alcohol, benzene, or paint thinner to clean the product. The use of inflammable cleaners and solvents may cause an explosion or fire.
- When unplugging the AC adapter, do not pull on the power cord. Hold the adapter unit when removing it from an outlet.
- Do not damage, twist, modify, heat, or place heavy objects on the AC adapter cord. A damaged cord may cause damage or injury through fire or electric shock.
- If the product emits a strange odor, heat, or smoke, discontinue use. Immediately remove the batteries taking care not to burn yourself as the batteries become hot with use. The continued use of a damaged product or part may cause injuries or fire.
- Take the product to a Minolta Service Facility when repairs are required.

## CAUTION

- Do not use or store the product in a hot or humid environment such as the glove compartment or trunk of a car. It may damage the product and batteries which may result in burns or injuries caused by heat, fire, explosion, or leaking battery fluid.
- If batteries are leaking, discontinue use of the product.
- The lens retracts when the camera is turned off. Touching the lens barrel while it is retracting may cause injury.
- The camera temperature rises with extended periods of use. Care should be taken to avoid burns.
- Burns may result if the memory card or batteries are removed immediately after extended periods of use. Turn the camera off and wait for it to cool.
- Do not fire the flash while it is in contact with people or objects. The flash unit discharges a large amount of energy which may cause burns.
- Do not apply pressure to the LCD monitor. A damaged monitor may cause injury, and the liquid from the monitor may cause inflammation. If liquid from the monitor makes contact with skin, wash the area with fresh water. If liquid from the monitor comes in contact with the eyes, immediately rinse the eyes with plenty of water and contact a doctor.
- When using the AC adapter, insert the plug securely into the electrical outlet.
- Do not use if the AC adapter cord is damaged.
- Do not cover the AC adapter. A fire may result.
- Do not obstruct access to the AC adapter; this can hinder the unplugging of the unit in emergencies.
- Unplug the AC adapter when cleaning or when the product is not in use.

## About this manual

The basic operation of this camera is covered between pages 10 and 25. This section of the manual covers the camera parts, preparation of the camera for use, and the basic camera operation for recording, viewing, and deleting images.

The other sections can be read as needed. Many of the features of this camera are controlled with menus. The menu navigation sections concisely describe how to change menu settings. Descriptions of the settings immediately follow the navigation sections.

Names of parts .....	8
Camera body.....	8
Mode dial.....	9
Getting up and running .....	10
Attaching the hand strap.....	10
Installing batteries .....	11
Battery condition indicator.....	12
Auto power off.....	12
Connecting the AC adapter (sold separately).....	13
Setting the language.....	14
Setting the date and time.....	14
Image storage.....	16
Basic recording and playback.....	18
Auto-recording mode display .....	18
Frame counter.....	18
Viewfinder .....	19
Handling the camera.....	19
Using the zoom lens .....	20
Basic recording operation .....	21
Indicator lamp.....	22
Focus lock.....	22
Special focusing situations.....	23
Playback mode display .....	24
Viewing images.....	24
Display button - playback mode.....	25
Deleting images.....	25
Auto-recording mode .....	26
Flash modes.....	26
Flash range.....	27
Display button - recording mode.....	27

Exposure compensation.....	28
What is an Ev? What is a stop? .....	29
White balance .....	30
Automatic white balance .....	30
Preset white balance.....	30
Movie-recording.....	31
Program-recording mode.....	32
Self-timer .....	32
Macro.....	33
Night portrait.....	33
Portrait.....	33
Landscape .....	33
Playback mode .....	34
Index playback .....	34
Enlarged playback.....	35
Playing back movies .....	35
Image copy.....	36
Viewing images on a television.....	37
Setup mode .....	38
Navigating the setup menu .....	38
Deleting all images.....	40
Format.....	40
Image quality .....	41
Buzzer .....	42
About DPOF.....	42
Creating a DPOF Print Order .....	43
Memory type .....	45
Video output.....	45
Data-transfer mode.....	46
System requirements .....	46
Connecting the camera to a computer.....	47
Connecting to Windows 98 and 98 Second Edition.....	49
QuickTime system requirements.....	51
Memory card folder organization .....	52
Uninstalling the driver software - Windows.....	53
Disconnecting the camera from the computer .....	54
Appendix .....	56
Troubleshooting.....	56
Care and storage .....	58
About Ni-MH batteries.....	60
Technical specifications.....	61

# NAMES OF PARTS

## Camera body

\* This camera is a sophisticated optical instrument. Care should be taken to keep these surfaces clean. Please read the care and storage instructions in the back of this manual (p. 58).

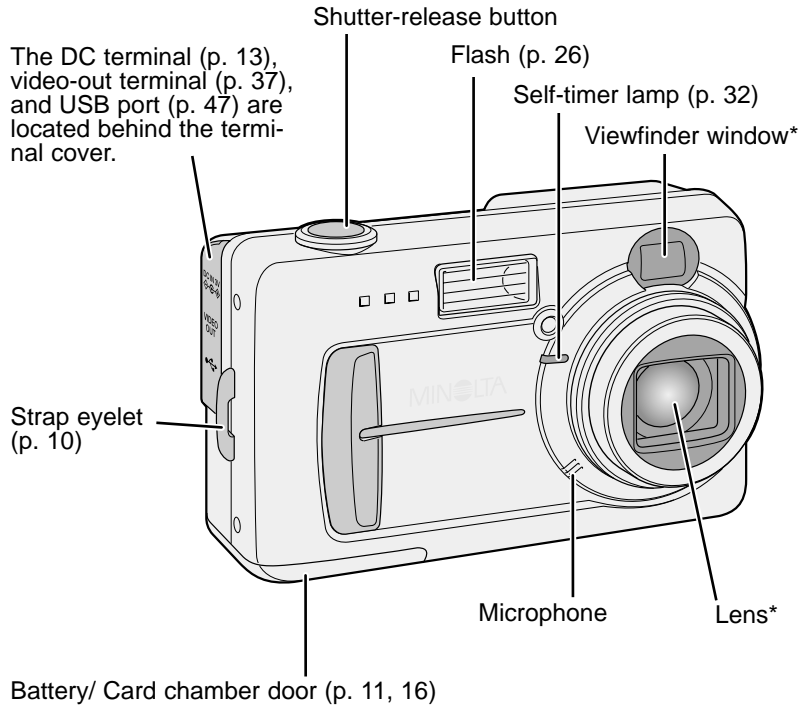



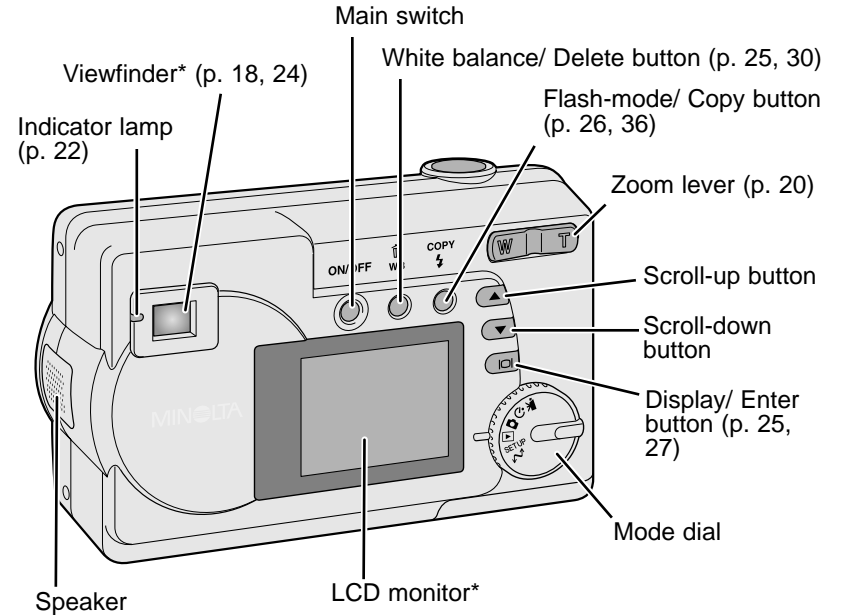



The tripod socket is located on the bottom of the body.

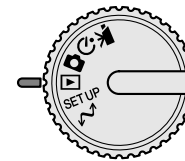

## Mode dial

This dial gives direct and easy access to the camera's major modes.



-  Movie-recording mode (p. 31)
-  Program-recording mode (p. 32)
-  Auto-recording mode (p. 18, 26)
-  Playback mode (p. 24, 34)
- SETUP Setup mode (p. 38)
-  Data-transfer mode (p. 46)

# GETTING UP AND RUNNING

## Attaching the hand strap

Always keep the strap around your wrist in the event that the camera is accidentally dropped.

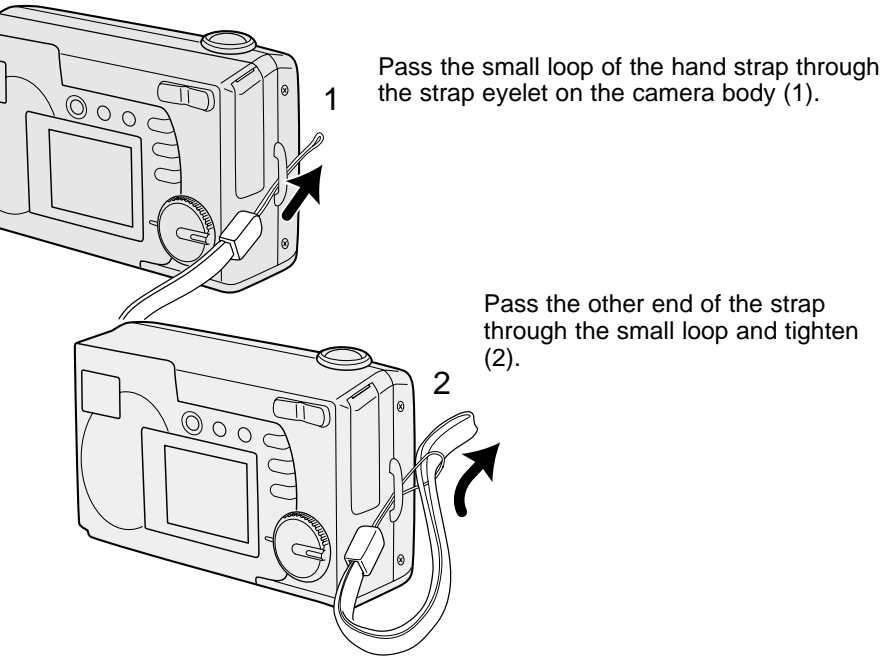

## Installing batteries

This digital camera uses two AA-size Ni-MH batteries or one CR-V3 lithium battery. When using Ni-MH batteries, fully recharge them with a battery charger suitable for complex electronic equipment. Although alkaline batteries can be used, their performance is very low and is not recommended for normal use. Do not use other types of AA batteries.

When replacing the batteries, the camera should be turned off.

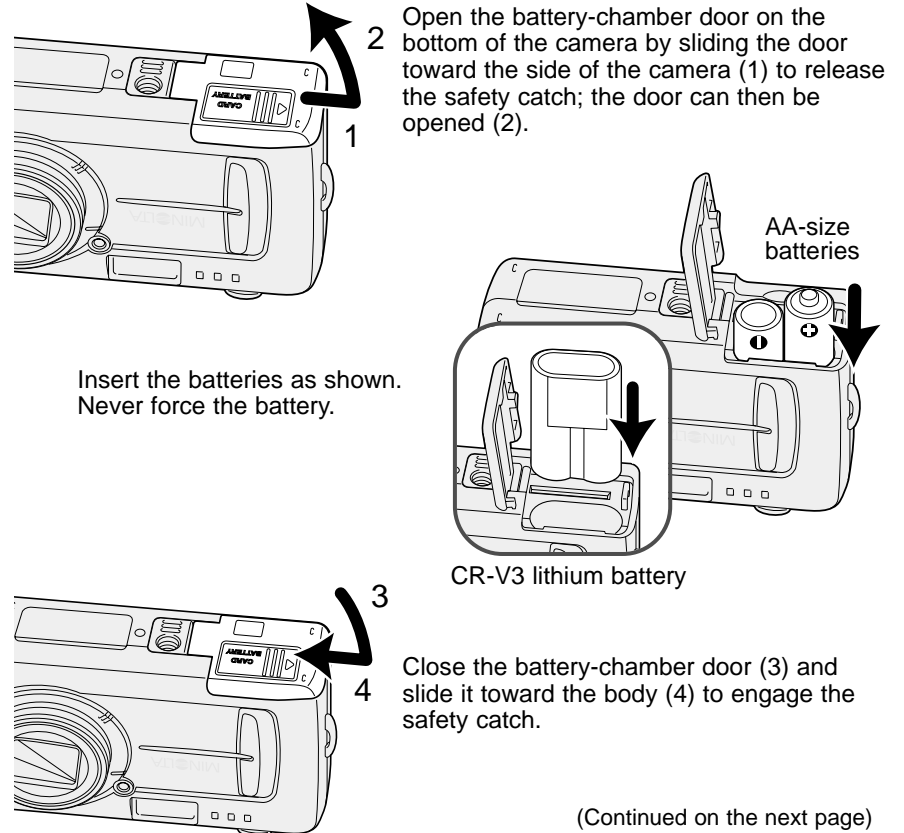

(Continued on the next page)

When replacing batteries, the date information will reset if there are no batteries in the camera for a few minutes. See page 14 if the date reset.

## Battery condition indicator

This camera is equipped with an automatic battery-condition indicator. When the camera is on, the battery-condition indicator appears on the LCD monitor. If it does not appear, the battery may be exhausted or installed incorrectly.

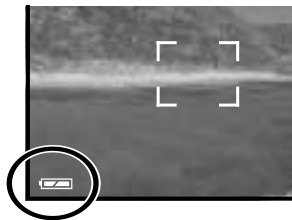

Full-battery indicator - the battery is fully charged.



Low-battery indicator - battery power is low. The battery should be replaced soon.

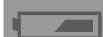

Low-battery warning - battery power is very low. The icon is red. The battery should be replaced as soon as possible.

Replace-battery message - power is insufficient for camera operation. Indicator lamp by the viewfinder turns red and blinks. Change the batteries. The shutter will not release.

## Auto power off

To conserve battery power, the camera will shut down if an operation is not made within three minutes. To restore power, press the main switch.

## Connecting the AC adapter (sold separately)

The AC Adapter AC-6 allows the camera to be powered from an electrical household outlet. The AC Adapter is recommended when the camera is interfaced with a computer or during periods of heavy use.

Always turn off the camera before changing between power supplies.



Lift the terminal cover from the top (1). The cover is attached to the body to prevent loss.

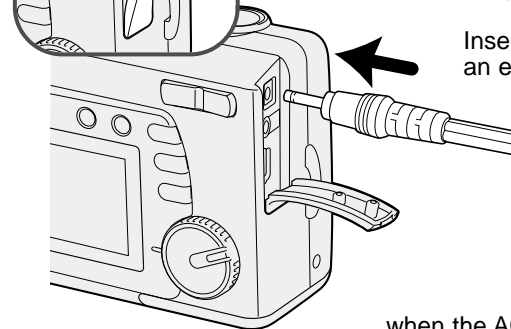

Insert the mini plug of the AC adapter into the DC terminal (2).

Insert the AC adapter plug into an electrical outlet.

when the AC adapter is used, camera will shut down if an operation is not made within 30 minutes.

## Setting the language

Depending on the region, the menu language may have to be set. Four languages are available: English, French, Spanish, and German.

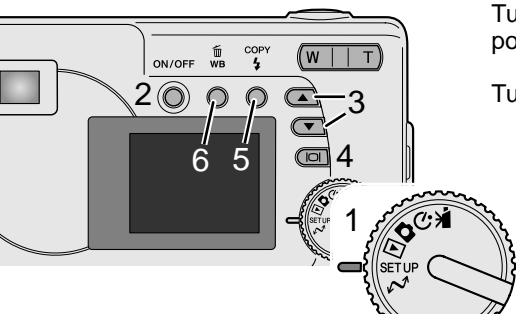

Turn the mode dial to the setup position (1).

Turn the camera on (2).

Use the scroll buttons (3) to select the language option. Press the display/enter button (4) to open language screen.

Use the scroll buttons (3) to highlight the appropriate language. Press the display/enter button (4) to select the language.

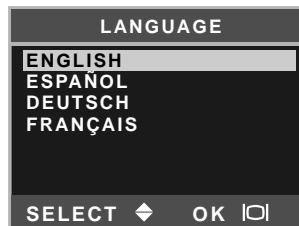
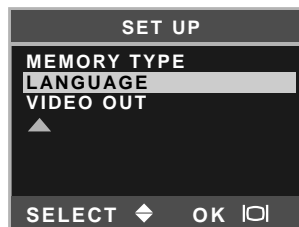

## Setting the date and time

The camera's clock and calendar must be set. When images are recorded, the image data is saved with the date and time of recording. The date and time display blinks if the clock and calendar are not set.

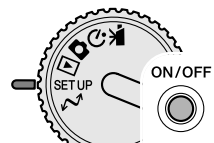

Turn the mode dial to the setup position (1).

Turn the camera on (2).



Use the scroll buttons (3) to select the date/time option. Press the display/enter button (4) to open the date/time screen.

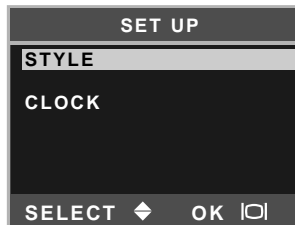
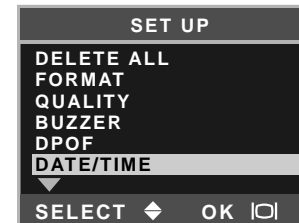

Use the scroll buttons (3) to select the style option. Press the display/enter button (4) to continue.

Use the scroll buttons (3) to select the date format. Press the display/enter button (4) to select the format.

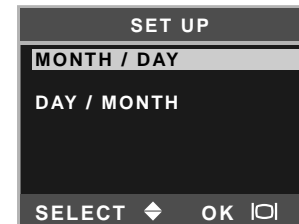

The main setup menu is displayed. Highlight the date/time option with the scroll buttons and press the display/enter button to continue.

Use the scroll buttons (3) to select the clock option. Press the display/enter button (4) to display the date/time setting screen.

Use the flash-mode/copy button (5) to select the item to be changed. Use the scroll buttons (3) to adjust the item.

Pressing the white-balance/delete button (6) will close the screen and cancel any changes made.

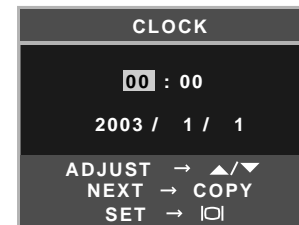

When the correct date and time is displayed, press the display/enter button (4) to set the clock and calendar.

## Image storage

This camera has an 8MB internal memory where the image can be stored without the need for a separate memory card. To switch between the internal memory and a memory card, see pages 38 and 45.

The LCD monitor shows where the images will be stored. "IN" indicates the internal memory and "EX" indicates an external memory card.

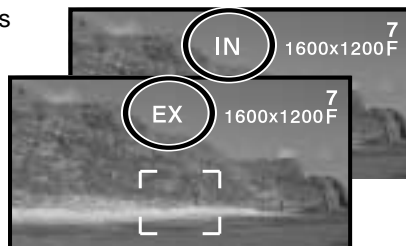

An SD Memory Card or MultiMediaCard, sold separately, can be inserted in the camera for image storage.

Always turn off the camera and confirm the indicator lamp is not lit before removing a memory card; damage and data loss may result.

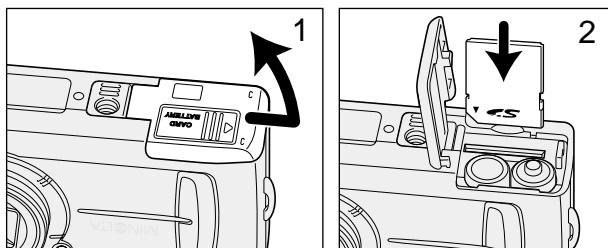

Open the card-slot door (1).

Insert the memory card all the way into the card slot until it stops (2). Insert the card so the face is toward the front of the camera. Always push the card in straight. Never force the card. If the card does not fit, check that it is oriented correctly.

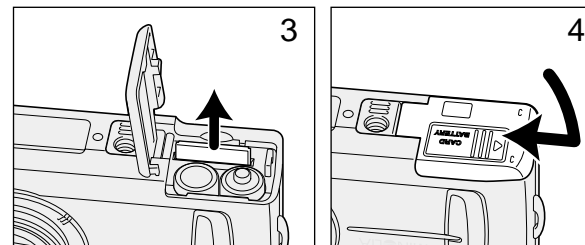

To remove a memory card, hold the edge of the card and pull it out straight (3). Take care when removing the card as it becomes hot with use.

Close the card-chamber door and slide it toward the body (4) to engage the safety catch.

If the card-protect message appears, the inserted card in the camera is locked. The card's write-protect switch must be in the unlock position to use the card. If the memory-card-error message appears, the inserted card may need to be formatted, or may not be compatible with this camera. To format the memory card, see pages 38 and 40. A card used in another camera may have to be formatted before being used. See the card's manual for details on card use.

Images are not transferred automatically to the memory card from internal memory when a memory card is inserted. To copy the data, see page 36.

# BASIC RECORDING AND PLAYBACK

This section covers the basic operation of this camera. Thoroughly familiarize yourself with the operations in this section before moving on to the other sections in the manual.

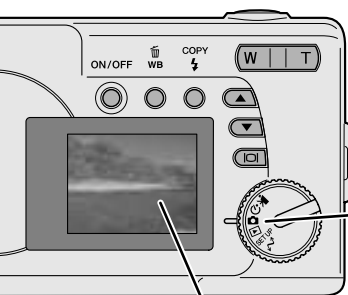

## Auto-recording mode display

When the mode dial is turned to the auto-recording mode position, the following display will appear in the LCD monitor. Indicators are displayed when camera settings are changed.

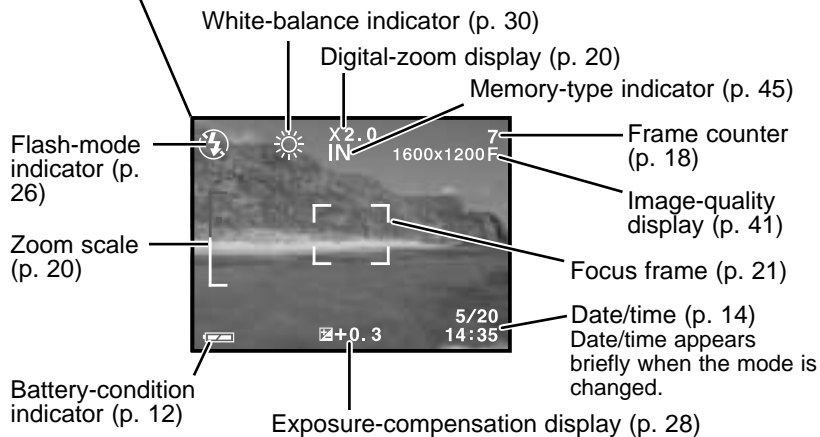
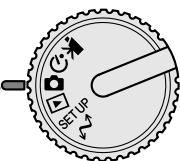

## Frame counter

The frame counter cannot exceed 999. When the number of recordable images exceeds this, 999 will be displayed. The frame counter will continue to count down when the number of recordable images falls below one thousand.

## Viewfinder

Because the optical viewfinder and the lens are slightly separated, the image seen through one is not exactly the same as the other; this is called parallax. Parallax can cause errors in framing at close distances and is more pronounced at longer focal lengths. When the subject is closer than 0.4m (1.3ft) in the macro mode, the use of the LCD monitor is recommended because it does not suffer from parallax. If the viewfinder is used, point the camera slightly upwards so that the top of the image is aligned with the close-framing guide.

### Close-framing guide

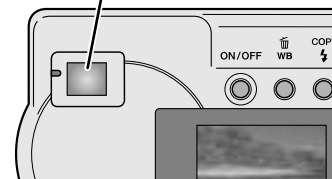
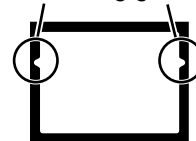

## Handling the camera

While using the viewfinder or LCD monitor, grip the camera firmly with your right hand while supporting the body with your left. Keep your elbows at your side and your feet shoulder-width apart to hold the camera steadily.

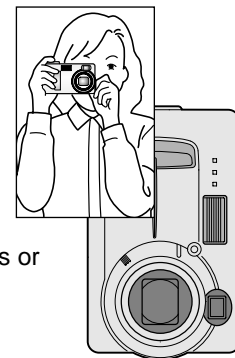

When taking vertical pictures, hold the camera so that the flash is above the lens with the grip to the top. Take care not to cover the lens with your fingers or the strap.

## Indicator lamp

The indicator lamp glows green when the camera is turned on. When the shutter-release button is pressed partway down, it shows the focus and flash status. See page 22 for the details.

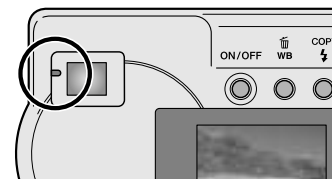

## Using the zoom lens

This camera is equipped with a 6.2 to 18.6mm optical zoom. This is equivalent to a 38 to 114mm zoom lens on a 35mm camera. In 35mm photography, focal lengths below 50mm are referred to as wide-angle; the angle of view is larger than that of the human eye. Above 50mm is referred to as telephoto and makes distant objects appear closer. The effect of the optical zoom is visible in both the viewfinder and LCD monitor.



The zoom lens is operated by the zoom lever. Pressing the right side (T) will zoom in to the telephoto position of the lens. Pressing the left side (W) will zoom out to the wide-angle position. The optical zoom position is indicated by the lower white section of the zoom scale in the LCD monitor.

If the zoom lever is pressed toward the telephoto position at the telephoto position of the optical zoom, the digital zoom will activate; this is indicated by the upper red section of the zoom scale. The digital zoom extends the power of the telephoto position of the optical zoom by up to 3X in 0.2X increments. When the digital zoom is active, the image magnification is displayed on the monitor.

Digital zoom magnification

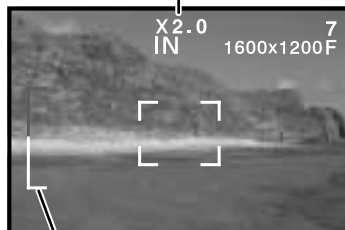

Digital zoom images are interpolated to the set image size. There can be some loss of quality with images taken with the digital zoom.

## Basic recording operation

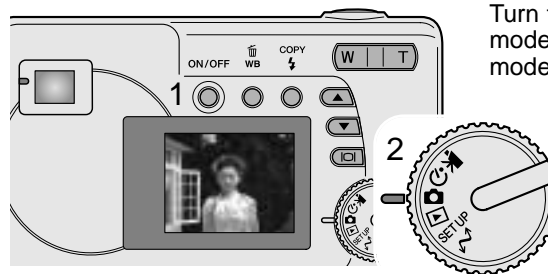

Turn the camera on (1) and turn the mode dial to the auto-recording mode (2).

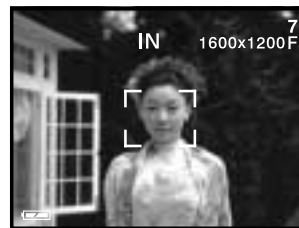

Place the subject within the focus frame.

- Make sure the subject is within the focus range of the lens: 0.6m - ∞ (2.0ft - ∞). For subjects closer than 0.6m, use the macro function (p. 33).

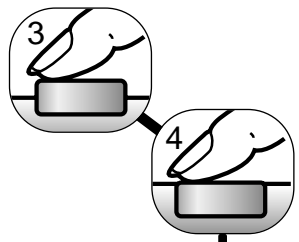

Press the shutter-release button partway down (3) to lock onto the subject and fix the exposure.

- The indicator lamp shows the status of focus and flash. See page 22 for the details.
- The focus frame turns red to confirm subject lock. If it remains white, the camera was unable to focus the subject. Repeat the previous steps.
- The shutter speed and aperture will appear indicating the exposure is locked.

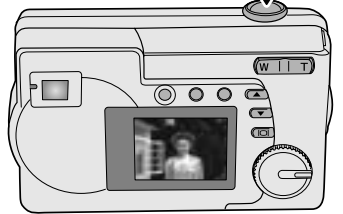

Press the shutter-release button all the way down (4) to take the picture.

- The green indicator lamp may blink indicating image data is being written to the memory card. Never turn the camera off or open the battery/card chamber door while data is being transferred.

## Indicator lamp

When the camera is on, the indicator lamp shows the camera status.

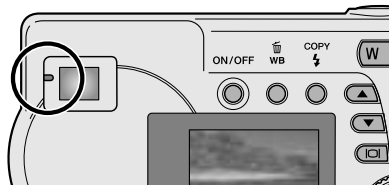

	When shutter-release button is not pressed	While shutter-release button is pressed partway down
Green and steady	Camera is on.	Focus is locked. Flash will not fire. The camera is ready to take the picture.
Orange and steady	–	Focus is locked. Flash will fire. The camera is ready to take the picture.
Green and blinks	Image data is being transferred to the card.	Cannot focus. Flash will not fire.
Orange and blinks	Flash is charging. LCD monitor is off.	Cannot focus. Flash will fire.

The shutter can be released when the camera cannot focus on the subject, the subject is too close, or a special situation is preventing the AF system from focusing. If the subject is too close, the indicator lamp may glow, but the subject will not be in focus.

## Focus lock

The focus-lock function is used when you want to compose the image with the subject off-center and outside the focus frame. Focus lock may also be used when a special focusing situation prevents the camera from focusing on the subject. This function is controlled with the shutter-release button.



Place the subject within the monitor focus frame or center the subject in the viewfinder. Press and hold the shutter-release button partway down to lock the focus.

- The indicator lamp glows steadily and the focus frame turns red when the focus is locked.



Without lifting your finger from the shutter-release button, recompose the subject within the image area. Press the shutter-release button all the way down to take the picture.

## Special focusing situations

The camera may not be able to focus in certain situations. If the autofocus system cannot focus on a subject, the indicator lamp blinks and the focus frame will not turn red. In this situation, focus-lock can be used to focus on an object at the same distance as the main subject and then the image can be recomposed on the monitor (p. 22).

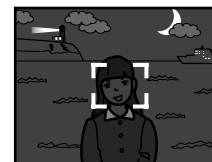

The subject is too dark.



The subject in the focus frame is low in contrast.



Two subjects at different distances overlap in the focus frame.



The subject is near a very bright object or area.

## Playback mode display

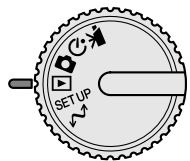

Images can be viewed in the playback mode. To view images, turn the mode dial to the playback position.

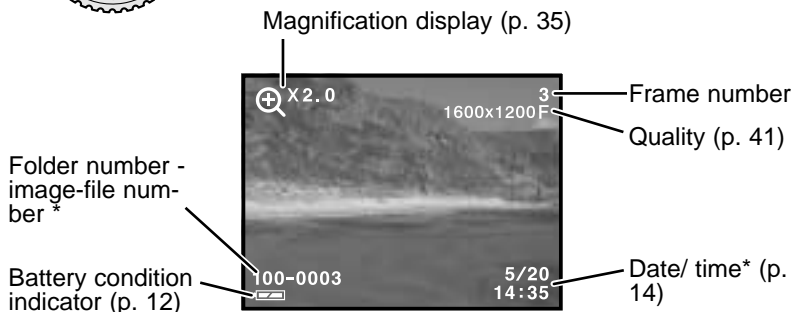

\* Folder number, image-file number, and date/time appear briefly when the mode is changed.

## Viewing images

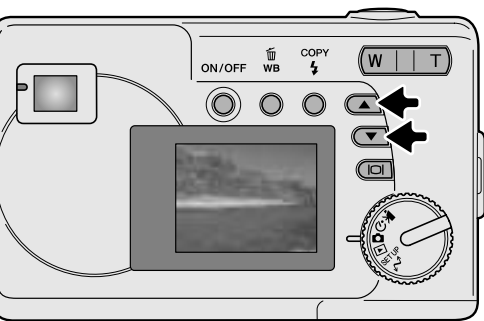

In the playback mode, use the scroll buttons to scroll through the images.

## Display button - playback mode

Pressing the display/enter button in the playback mode switches between the full display and the image-only display.

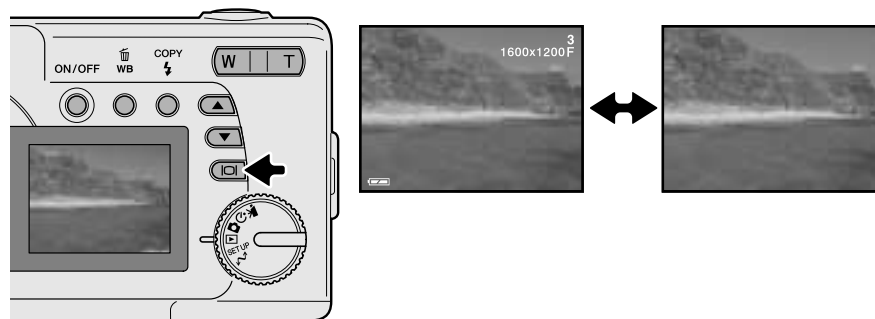

## Deleting images

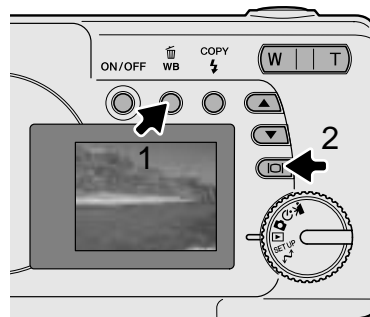

To delete the displayed image, press the white-balance/delete button (1). A confirmation screen will appear.

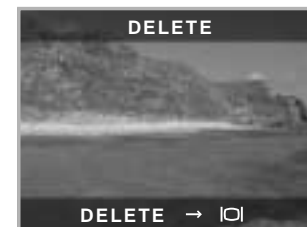

Press the display/enter button (2) to delete the image, or press any other button to cancel the delete operation.

# AUTO-RECORDING MODE

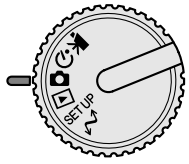

This section covers the operation in auto-recording mode. The sophisticated technology employed in this mode frees the photographer from complicated camera settings. Although automated, the camera's operation can be changed to meet various conditions as well as to suit personal shooting preferences.

## Flash modes

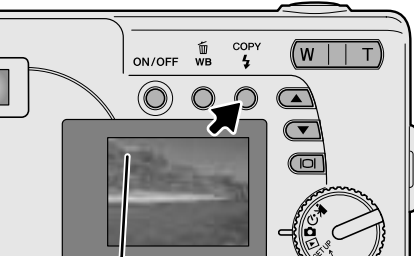

No Indicator	Autoflash
⚡	Fill-flash
👁️ AUTO	Autoflash with red-eye reduction
⚡	Flash cancel

To set the flash mode, simply press the flash-mode/copy button on the back of the camera until the appropriate mode is indicated.

**Autoflash** - the flash fires automatically in low-light situations. If the flash will fire, the flash indicator will appear on the LCD monitor when the shutter-release button is pressed partway down.

**Fill-flash** - the flash fires with each exposure regardless of the amount of ambient light. Fill-flash can be used to reduce harsh shadows caused by strong direct light or sunshine.

**Red-eye reduction** - multiple flashes are used before the main flash burst to reduce red-eye; an effect caused by

light reflected from the retina. Use in low-light conditions when taking photographs of people or animals. The pre-flashes contract the pupils of the subject's eyes.

**Flash cancel** - the flash will not fire. Use flash cancel when flash photography is prohibited, natural light is desired to illuminate the subject, or the subject is beyond the flash range.

## Flash range

The camera will automatically control the flash output. For well-exposed images, the subject must be within the flash range.

Flash range

0.6m ~ 2.5m (2.0 ft. ~ 8.2 ft.)

## Display button - recording mode

The display button controls the LCD monitor display. The display cycles to the next position each time the button is pressed: full, simple, and monitor off.

Battery power can be conserved by turning the monitor off and using the viewfinder to take pictures. When the digital zoom is active, the monitor will automatically turn on and cannot be turned off.

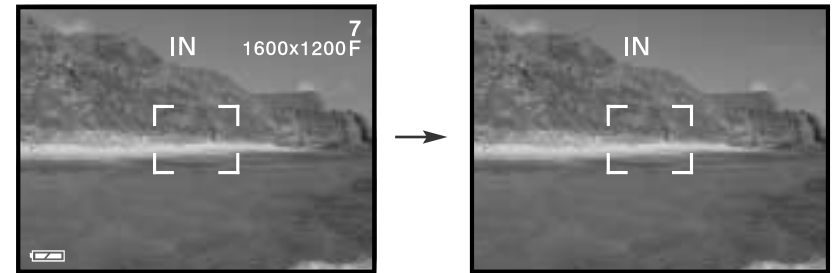

Full

Simple

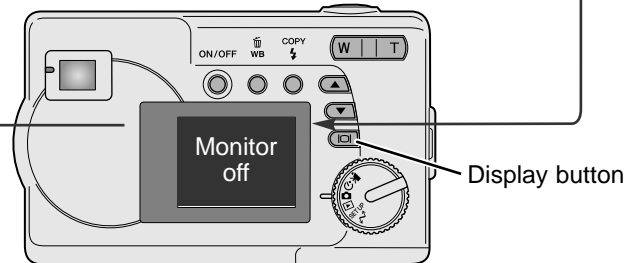

## Exposure compensation

The camera exposure can be adjusted to make the final picture lighter or darker by as much as  $\pm 2\text{Ev}$  in  $1/3$  increments. This function is only available in the auto-recording mode.

Exposure compensation must be set before the image is captured. When making adjustments to exposure, the amount of compensation is shown at the bottom of the LCD monitor. After the setting is made, the shutter-speed and aperture displays will indicate the actual exposure. Because the exposure can be adjusted in fine steps, the shutter speed or aperture value displayed may not change.

When set to any value other than 0.0, the exposure-compensation indicator and the degree of compensation will remain on the LCD monitor as a warning.

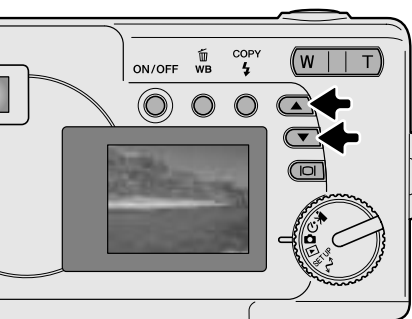
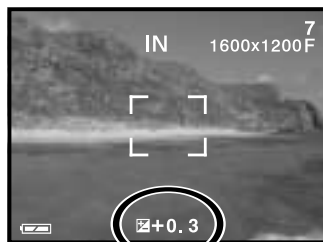

Compose the picture on the monitor and press one of the scroll buttons to activate exposure compensation; the camera exposure is locked. Changing zoom or mode dial position will cancel exposure compensation.

Set the degree of exposure-compensation using the scroll buttons. Changes to exposure are visible in the live image. The exposure is locked until picture is taken.

If the flash mode is set to autoflash, the flash will not fire. To use the flash, set the flash mode to fill-flash.

If the LCD monitor is off, it will turn on automatically when exposure compensation is active, but can be turned off if necessary.

Sometimes the camera's exposure meter is deceived by certain conditions. Exposure compensation can be used in these situations. For example, a very bright scene, such as a snowy landscape or a white sandy beach, can appear too dark in the captured image. Before taking the picture, adjusting the exposure by  $+1$  or  $+2$  EV will result in an image with normal tonal values.

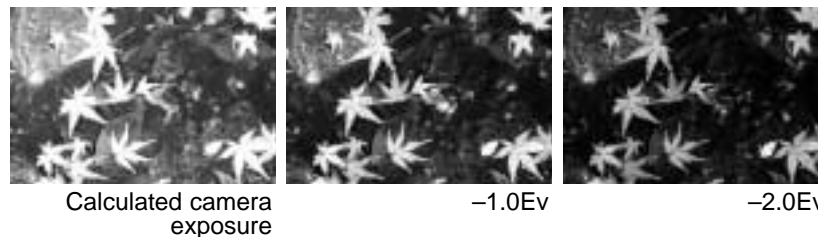

In the example above, the dark water caused the camera to overexpose the image making it bright and washed-out. By compensating the exposure, detail is brought out in the leaves, and the stones and water appear richer.

### What is an Ev? What is a stop?

Ev stands for exposure value. The term stop comes from the name of aperture plates used in early lenses. A change of one Ev or one stop will adjust the exposure calculated by the camera by a factor of two.

Change in Ev	Change in stops	Adjustment to exposure
+2.0 Ev	+2 stops	4X as much light
+1.0 Ev	+1 stop	2X as much light
0.0 Ev	Calculated exposure	
-1.0 Ev	-1 stop	1/2 as much light
-2.0 Ev	-2 stops	1/4 as much light

## White balance

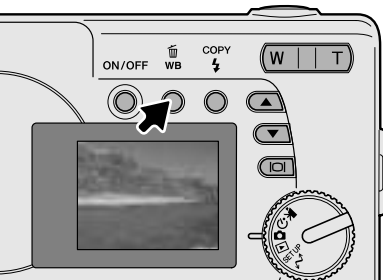

White balance is the camera's ability to make different types of lighting appear neutral. The effect is similar to selecting daylight or tungsten film, or using color compensating filters in conventional photography. An indicator will be displayed on the monitor if a setting other than auto white-balance is chosen. White balance is set by pressing the white-balance/delete button. Each time the button is pressed, the white balance mode cycles in the following order: Automatic, Daylight, Cloudy, Tungsten, and Fluorescent.





### Automatic white balance

The automatic white balance compensates for the color temperature of a scene. In most cases, the auto setting will balance the ambient light and create beautiful images, even under mixed-lighting conditions. When the built-in flash is used, the white balance is set for the color temperature of the flash. No indicator is displayed for automatic white balance.

### Preset white balance

Preset white-balance settings must be set before the image is taken. Once set, the effect is immediately visible on the LCD monitor.

If the flash is used, white balance is automatically set to the color temperature of the flash. Use flash cancel to prevent the flash from firing.

-  **Daylight** - for outdoor and sunlit subjects.
-  **Cloudy** - for overcast outdoor scenes.
-  **Tungsten** - for incandescent lighting: household filament light bulbs.
-  **Fluorescent** - for fluorescent lighting: office ceiling lights.

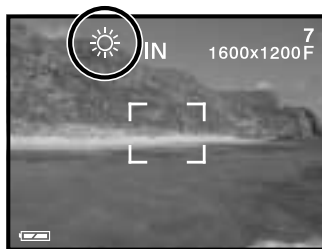

## MOVIE-RECORDING MODE



Recording time

This camera can record digital video with sound. Approximately 23 seconds can be recorded in the internal memory. On a memory card, a maximum of 60 seconds can be taken depending on the card capacity. Autofocus is not used in movie recording.

Before recording, the maximum recording time in seconds that can be recorded on the next movie clip is shown.

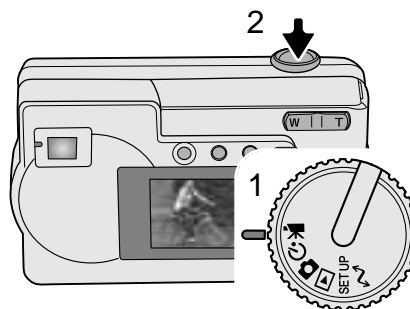

Shooting digital video is simple. Set the mode dial to movie recording (1). Frame the picture and press the shutter-release button (2) all the way down and release to start recording.



Countdown in seconds

During recording, the digital zoom is available; the optical zoom can only be adjusted before recording starts. The camera will continue to record until the recording time is used or the shutter-release button is pressed again. When recording, the frame counter will count down the remaining time.

# PROGRAM-RECORDING MODE

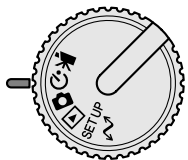

In the program-recording mode, various subject programs are available including a self-timer and macro mode. Except for exposure compensation, the function in the auto-recording mode are available in the program-recording mode.

Turn the camera on and turn the mode dial to the program-recording mode.

Use the scroll-down button to cycle through the program modes as shown. The scroll-up button will change the modes in reverse order.

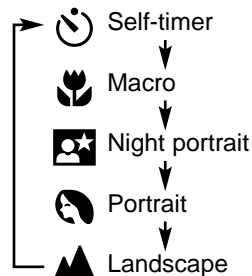
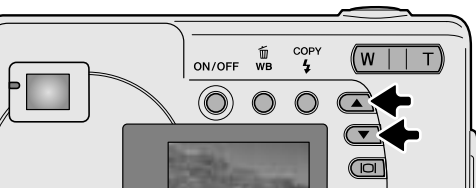

## Self-timer

Used for self-portraits, the self-timer will delay the release of the shutter for approximately ten seconds after the shutter-release button is pressed. With the camera on a tripod, compose the picture so the subject is within the focus frames. Press the shutter-release button partway down to lock the exposure and focus (1). Press the shutter-release button all the way down to begin the countdown (2). Because focus and exposure are determined when the shutter-release button is pressed, do not stand in front of the camera when taking a self-timer image. Always confirm the focus with the red focus frame before beginning the countdown (p. 21).

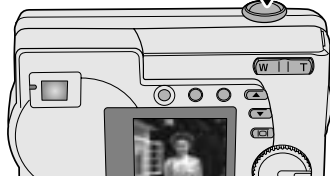
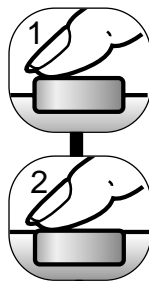

During the countdown, the self-timer lamp on the front of the camera (3) will start to blink and is accompanied by an audio signal if on. A few seconds before the exposure, the self-timer lamp will blink rapidly. Changing the position of the mode dial or pressing the shutter-release button will stop the countdown.

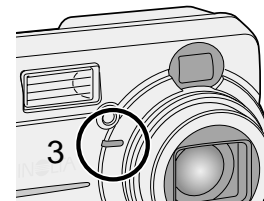

## Macro



Used for close-up photography between 8 - 60 cm (3.2 - 24 in.) at the wide-angle zoom position and 40 - 60 cm (16 - 24 in.) at the telephoto zoom position, from the camera lens. Because of parallax, the LCD monitor or close-framing guide should be used to compose the picture. Use of flash is not recommended.

## Night portrait



The flash and ambient exposures are balanced to reveal the subject and background in low light. Ask your subject not to move after the flash burst; the shutter may still be open for the background exposure. The flash mode is set to fill-flash automatically; to take pictures of landscapes at night, set the flash mode to flash cancel (p. 26). The use of a tripod is recommended.

## Portrait



For pictures of people. Most portraits look best at a telephoto setting; longer focal lengths do not exaggerate facial features and the shallower depth of field softens the background. The flash mode is set to autoflash automatically, but can be changed.

## Landscape



For pictures of scenery. The flash mode is set to flash cancel and white balance is set to daylight automatically, but can be changed.

# PLAYBACK MODE

The basic functions in this mode are described on pages 24 and 25. This section covers the advanced functions of this mode.

## Index playback

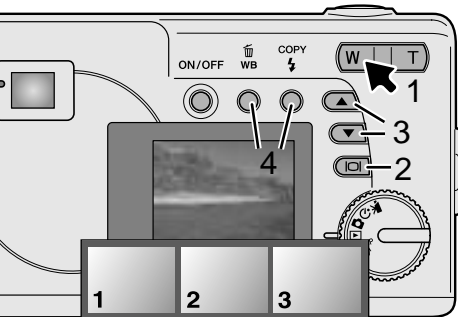

In the playback mode, pressing the left side (W) of the zoom lever (1) will change the LCD monitor display from single-frame playback to a nine-frame index playback display. The monitor will return to single-frame playback if either side of the zoom lever is pressed again.

In index playback, pressing the display/enter button (2) will turn the image-selection frame on or off.

When frame is not displayed, pressing the scroll buttons (3) shows the next or previous nine images.

When frame is displayed, specific images can be selected. To move the frame up and down, press the scroll buttons (3). Use the white-balance/delete button and flash-mode/copy button to move the frame left and right (4).

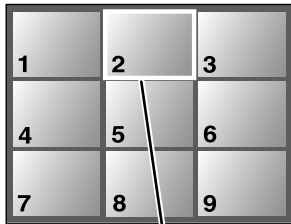
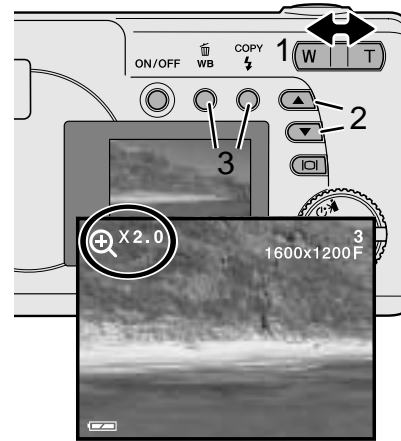

Image-selection frame

## Enlarged playback



In the playback mode, a still image can be enlarged up to 4X in 0.5 increments for closer examination.

With the image to be magnified displayed, press the right side (T) of the zoom lever (1) to activate the enlarged playback mode. The degree of magnification is displayed on the LCD monitor. Use the zoom lever (1) to increase or decrease the magnification.

To scroll the enlarged image up and down, press scroll buttons (2). To scroll left and right, use white-balance/delete and flash-mode/copy buttons (3).

## Playing back movies



To play back movie clips, use the scroll buttons to display the movie file.

Press the shutter-release button (1) to play back the displayed movie file.

Press the shutter-release button again to pause the movie; press it again to resume the playback. The movie repeats until the shutter-release button is pressed or another image is selected with the scroll buttons.



Press the display button (2) to view the movie with or without the guidance bar.

## Image copy

Images are stored either in the 8MB internal memory or in a memory card. Stored images can be copied between the internal memory and a memory card. The copy function makes exact copies of still image or movie files. DPOF settings are not copied with image files. Files are copied from the selected memory. To switch between the internal memory and a memory card, see pages 38 and 45.

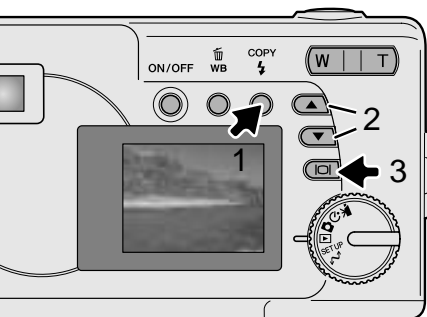

To copy image files, press the flash-mode/copy button (1).



Press the copy button (1) to select either the one image or all images option. The one image option only copies the displayed image; use the scroll buttons (2) to display the image to be copied. If the all images option is selected, all the image files in the internal memory or card will be copied.

To execute the copy command, press the display/enter button (3).

If the amount of data exceeds the memory capacity of the location it is being copied to, the memory-full message appears. Decrease the number of the images to be copied or delete unnecessary images to create space.

## Viewing images on a television

It is possible to view camera images on your television. The camera has a video-out terminal to make the connection using the supplied Video cable. The camera is compatible with the NTSC and PAL standards. The video-output setting can be checked and set in the setup mode (p. 38).

1. Turn off the television and the camera.
2. Insert the mini-plug end of the Video cable into the camera's video-out terminal.
3. Plug the yellow end of the Video cable into the video input terminals on the television.
4. Turn the television on.
5. Change the television to the video channel.
6. Turn the camera's mode dial to the playback position and turn the camera on. The camera's monitor will not activate when the camera is attached to a television. The playback-mode display will be visible on the television screen.
7. View images as described in the playback section.

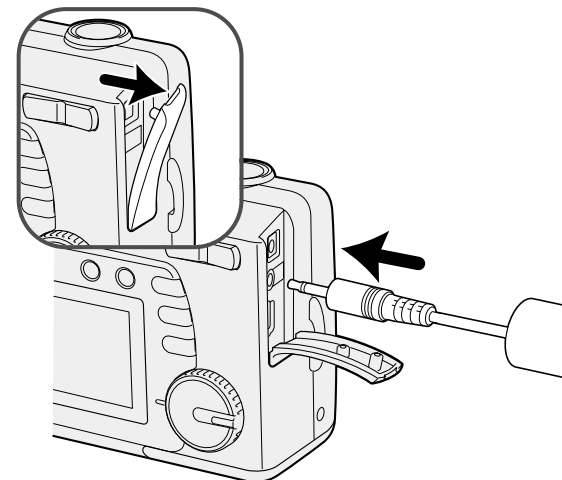

- The movie clip's audio track will be played back on the camera.

# SETUP MODE

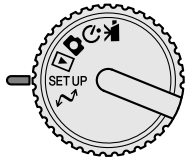

The setup mode is used to control the camera's functions and operation. The navigating the setup menu section covers the operation of the menu. The section is followed by detailed descriptions of the settings.

## Navigating the setup menu

To access the menu, simply turn the mode dial to the setup position. The scroll buttons are used to move the cursor in the menu. Pressing the display/enter button will select a highlighted option.

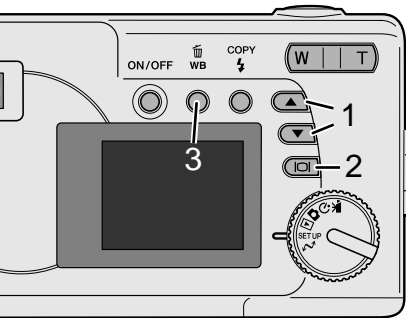

With the setup mode is selected in the mode dial, use the scroll buttons (1) to scroll through the menu options. The second half of the menu will appear after scroll past the last option displayed. Highlight the option whose setting needs to be changed.

With the menu option to be changed highlighted, press the display/enter button (2); the settings will be displayed with the current setting highlighted. To return to the menu options, press the white-balance/delete button (3).

Use the scroll buttons (1) to highlight the new setting.



Press the display/enter button (2) to select the highlighted setting.



Once a setting has been selected, the cursor will return to the menu options. Setting can continue to be made.

DELETE ALL	NO	YES
FORMAT	NO	YES
QUALITY	2048x1536 SUPER	1600x1200 FINE
	1600x1200 NORMAL	800x600 FINE
	800x600 NORMAL	
BUZZER	ON	OFF
DPOF	SELECT IMAGES	ALL IMAGES
DATE/TIME	STYLE	MONTH/DAY
	CLOCK	DAY/MONTH
		CLOCK
MEMORY TYPE	INTERNAL	EXTERNAL
LANGUAGE	ENGLISH	ESPAÑOL
	DEUTSCH	FRANÇAIS
VIDEO OUT	NTSC	PAL

## Deleting all images



Deleting permanently erases the file. Once deleted, a file cannot be recovered. Care should be taken when deleting images.

All the images in either the internal memory or a memory card can be deleted at once. The internal memory or the memory card must be selected with the setup menu first. See navigating the setup menu section on page 38.

When the delete-all option is selected, choosing “Yes” and pressing the display/enter button immediately deletes all the images.

## Format



When a memory card or internal memory is formatted, all data is erased.

The formatting function is used to erase all data in either a memory card or the internal memory. Before formatting, copy the data to a computer or storage device. Always format the memory card using the camera; never use a computer to format the camera or card.

The internal memory or the memory card must be selected with the setup menu first. See navigating the setup menu section on page 38. When the format option is selected, choosing “Yes” and pressing the display/enter button immediately formats the card or internal memory and erases all images.

If the memory-card-error message appears, the inserted card in the camera may need to be formatted. A memory card used in another camera may also have to be formatted before being used.

## Image quality

Image quality is based on two factors: image size and compression rate.

Image size is the pixel dimensions of the image such as 1600 x 1200 pixels. The greater the image size, the larger the file size. Choose image size based on the final use of the image - smaller images will be more suitable for web sites whereas larger sizes will produce higher quality prints.

All images are compressed and saved as JPEG files. The compression rate is indicated by FINE, NORMAL, and SUPER. FINE images have the lowest compression rate and the largest file size. NORMAL is sufficient for standard use. 2048x1536 SUPER quality creates the largest images for prints, but because the image size is interpolated and the compression rate is high, some loss of image quality may be noticed.

Image quality must be set before the picture is taken. Changes are displayed on the LCD monitor. See navigating the setup menu section on page 38 to select the quality option.

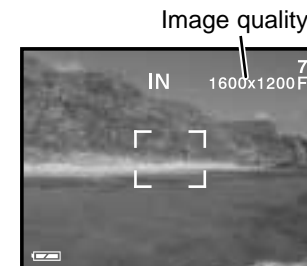

If quality is changed, the frame counter will display the approximate number of images that can be recorded at that setting. Images with differing qualities can be saved in the same memory location. The number of images that can be stored is determined by the size of the memory and the file size of the images. The actual file size is determined by the scene; some subjects can be compressed further than others.

(Continued on the next page)

Quality	Approximate file sizes	Approximate number of images that can be stored	
		8MB SD memory card	8MB internal memory
2048x1536 SUPER	768KB	7	7
1600x1200 FINE	853KB	6	7
1600x1200 NORMAL	640KB	14	16
800x600 FINE	213KB	25	27
800x600 NORMAL	160KB	55	60

### Camera Notes

The frame counter indicates the approximate number of images that can be stored in either the internal memory or the memory card at the camera's image quality setting. If the settings are changed, the frame counter adjusts accordingly. Because the counter uses approximate file sizes, the actual image taken may not change the counter or may decrease it by more than one. When the frame counter displays zero, it indicates no more images at the image quality setting can be captured. Changing those settings may allow more images to be saved to the card.

## Buzzer

Every time a button is pressed, an audio signal will give a positive confirmation of the operation. The audio signals can be turned off. See navigating the setup menu section on page 38 to select the buzzer option.

## About DPOF

This camera is supported by DPOF™ version 1.1. The DPOF (Digital Print Order Format) allows direct printing of still images from digital cameras. After the DPOF file is created on a memory card, the card is simply taken to a photofinishing service or inserted into the memory-card slot of DPOF compatible printers. When a DPOF file is created, a misc. folder is automatically created (p. 52). Only a DPOF file created on a memory card can be used for printing.

## Creating a DPOF Print Order

The print menu option is used to set an order for standard prints from still images on the memory card. Single, multiple, or all images can be printed. Date imprinting can also be set. See navigating the setup menu section on page 38.

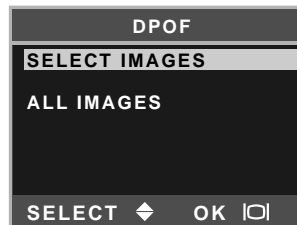

When the DPOF-setting screen appears, use the scroll buttons to choose the select-images option to create a DPOF file for single or multiple images, or the all-images option to create a DPOF file for all images on the memory card. Press the display/enter button to enter the setting.



When the select-images option is chosen, the print-order screen appears. Use the scroll buttons to select the image to be printed.



When the image is displayed, press the copy button. The copies option is highlighted.

Use the scroll buttons to select the number of prints for the displayed image.



Press the copy button. The date option is highlighted.

Choose "Yes" or "No" using the scroll buttons. "Yes" will print the date and time of recording next to the image. The date option cannot be set if the number of copies is 0.

Every time the copy button is pressed, the functions cycle among selecting images, the number of copies, and date imprinting. Continue until all the images to be printed are selected. Pressing the delete button will cancel the DPOF setting screen and any changes made.

 With all the images to be printed selected, press the display/enter button to enter the settings.



When the all-images option is chosen on page 43, the print-order screen for all images appears. Use the scroll buttons to select the number of copies for all the images on the memory card.



COPY



Press the copy button to set the date and time as described above, if required.



 With all the images to be printed selected, press the display/enter button to enter the settings.

If the all-frames setting was used to create a print order, any additional images recorded afterwards will not be included in the order.



If a DPOF order has already been created, the print-setting screen will open. The reset option cancels all print settings and allows new settings to be made. The edit option allows the current settings to be changed.

DPOF files created with another camera will be canceled. After the pictures have been printed, the DPOF file will still remain on the memory card and must be canceled manually. Some printer may not recognize the date setting and not print the information.

## Setting the date and time

See page 14 to set the date and time.

## Memory type

This camera stores images in either the 8MB internal memory or a separate SD Memory Card or MultiMediaCard.

Memory type affects all the camera operations. If “Internal” (internal memory) is selected, the images will be stored in the internal memory in the recording modes, and playback, format, and delete-all functions will be executed only for the images in the internal memory. If “External” (memory card) is selected, all the images will be stored in the card, and all the functions will be executed for the card only.

In the recording mode, the LCD monitor shows the current memory in use. “IN” indicates the internal memory and “EX” indicates the external memory card.

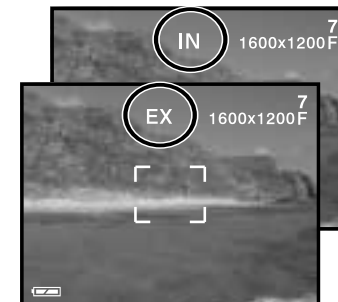

When a memory card is inserted, the setting changes to “External” automatically, but can be changed if necessary. Always confirm the memory type before taking pictures.

## Language

The language used in the menus can be changed. See page 14.

## Video output

Camera images can be displayed on a television (p. 37). The video output can be changed between NTSC and PAL. North America uses the NTSC standard and Europe uses the PAL standard. Check which standard is used in your region to play back images on your television set.

# DATA-TRANSFER MODE

Read this section carefully before connecting the camera to a computer. Instructions on using and installing the DiMAGE Viewer software are found in the supplied software manual. The DiMAGE manuals do not cover the basic operation of computers or their operating systems; please refer to the manual supplied with your computer.

## System requirements

For the camera to be connected directly to the computer and used as a mass-storage device, the computer must be equipped with a USB port as a standard interface. Both the computer and the operating system must be guaranteed by their manufacturers to support USB interface. The following operating systems are compatible with the camera:

IBM PC / AT Compatible	Macintosh
Windows 98, 98SE, Me, 2000 Professional, and XP.	Mac OS 9.0 ~ 9.2.2, Mac OS X v10.1.3 ~ 10.1.5, and v10.2.1 ~ 10.2.3

Check the Minolta web site for the latest compatibility information:  
North America: <http://www.minoltausa.com>  
Europe: [http://www.minoltaeurope.com/pe/digital/languages\\_stage.html](http://www.minoltaeurope.com/pe/digital/languages_stage.html)

Users with Windows 98 or 98 second edition will need to install the driver software on the included DiMAGE Viewer CD-ROM (p. 49). No special driver software is required for other Windows or Macintosh operating systems.

Customers who have bought a previous DiMAGE digital camera and have installed the Windows 98 driver software must repeat the installation procedure. The updated version of the driver software included on the supplied DiMAGE Viewer CD-ROM is required for the operation of the DiMAGE E223 with a computer. The new software will have no effect on the performance of older DiMAGE cameras.

## Connecting the camera to a computer

Confirm the battery has sufficient power before connecting the camera to a computer, the full-battery indicator should be displayed on the monitor. The auto power off function is disabled when the camera is connected to a computer. The use of the AC adapter (sold separately) is recommended over the use of the battery. For users with Windows 98 or 98SE, read the section on how to install the required USB driver before connecting the camera to a computer (p. 49).

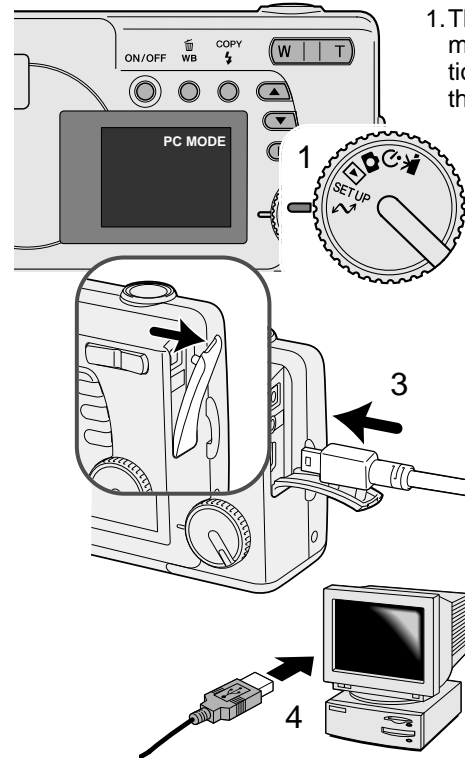

1. The memory-type option in the setup mode must be set to the storage location of the images (p. 38 and 45). Turn the mode dial to the data transfer position.
2. Start up the computer. The computer must be on before connecting the camera.
3. Open the terminal cover. Attach the smaller plug of the USB cable to the camera. Make sure the plug is firmly attached.
4. Attach the other end of the USB cable to the computer's USB port. Make sure the plug is firmly attached.
  - The camera should be connected directly to the computer's USB port. Attaching the camera to a USB hub may prevent the camera from operating properly.
  - When the camera is connected to a computer, the LCD monitor is off.

(Continued on the next page)



Windows XP

When the camera is properly connected to the computer, a drive icon, or volume, will appear. When using Windows XP or Mac OS X, a window will open requesting instructions on what to do with the image data; follow the directions in the window. If the computer does not recognize the camera, disconnect the camera and restart the computer. Repeat the connection procedure above.



Mac OS X



Windows



Mac OS X

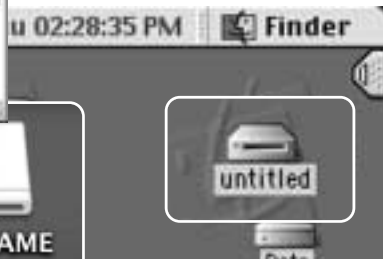

Mac OS

The volume name varies between memory cards.

## Connecting to Windows 98 and 98 Second Edition

The USB driver is required for Windows 98 and 98 Second Edition. No special driver software is required for other Windows or Macintosh operating systems.

During installation, if the operating system requests the Windows 98 CD-ROM, insert it into the CD-ROM drive and follow the accompanying instructions on the screen.

To install the Windows 98 driver, follow the instructions in the connecting-the-camera-to-a-computer section on page 47.

When the camera is plugged into the computer, the operating system will detect the new device and the add-new-hardware-wizard window will open. Place the DiMAGE Viewer CD-ROM in the CD-ROM drive. Click "Next."



Choose the recommended search for a suitable driver. Click "Next."

(Continued on the next page)

Choose to search for the driver in the CD-ROM drive. Click "Next."



The add new hardware wizard will confirm the location of the driver. Click "Next" to install the driver in the system.

- The letter designating the CD-ROM drive will vary between computers.

The last window will confirm the driver has been installed. Click "Finish" to close the add new hardware wizard. Restart the computer.

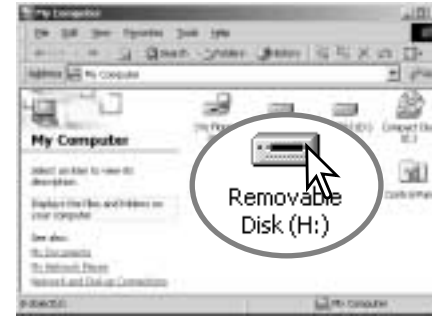
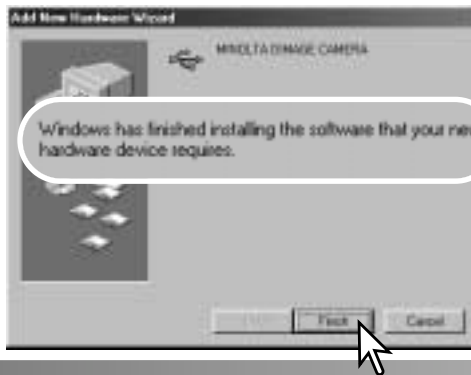

When the my-computer window is opened, a new removable-disk icon will be displayed. Double click on the icon to access the camera's internal memory or memory card; see page 48.

## QuickTime system requirements

<b>IBM PC / AT Compatible</b>
Pentium-based computer
Windows 95, 98, 98SE, NT, Me, 2000 Professional, or XP.
32MB or more of RAM
Sound Blaster or compatible sound card
DirectX 3.0 or later recommended

To install QuickTime, follow the instructions in the installer. Macintosh users can download the latest version of QuickTime free of charge from the Apple Computer web site: <http://www.apple.com>

## Auto power save (data-transfer mode)

If the camera does not receive a read or write command within 30 minutes, it will shut down to save power. When the camera shuts down, an unsafe-removal-of-device warning may appear on the computer monitor. Click "OK." Neither the camera or computer will be damaged in this operation.

Turn off the camera. Remake the USB connection by turning on the camera.

## Memory card folder organization



Drive Icon

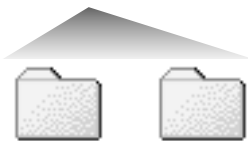

Dcim

Misc



100MLT32



PICT0001.JPG  
Still image



PICT0002.AVI  
Movie image with  
audio

Once the camera is connected to the computer, image files can be accessed by double clicking on icons. Image folders are located in the DCIM folder. To copy images, simply drag and drop the file icon into a location in the computer. Files and folders in the internal memory or memory card can be deleted using the computer. Never format the internal memory nor memory card from the computer; always use the camera to format the memory. Only files recorded by the camera should be stored in the internal memory or memory card.

Image and movie file names begin with "PICT" followed by a four-digit file number and a jpg or avi extension.

If the all-images copy function (p. 36) is used, a new folder is created. When a folder is created, the first three digits in the folder name will be one greater than the largest folder number on the card. When the index number in the image file name exceeds 9,999, a new folder will be created with a number one greater than the greatest folder number on the memory card: e.g. from 100MLT32 to 101MLT32.

The number in the image file name may not correspond to the frame number of the image. As images are deleted in the camera, the frame counter will adjust itself to show the number of images on the card and reassign the frame numbers accordingly. The serial numbers used with image files will not change when an image is deleted. When a new image is recorded, it will be assigned a number one greater than the largest serial number in the folder.

## Camera Notes

Image files contain exif tag data. This data includes the time and date the image was recorded as well as the camera settings used. This data can be viewed with the camera or the DiIMAGE Viewer software. If a camera image is opened in a photo-retouching application like Adobe Photoshop, and then the image is saved overwriting the original data, the exif tag information is erased. When using software other than the DiIMAGE Viewer, always make a backup copy of the image files to protect the exif tag data.

## Uninstalling the driver software - Windows

1. Connect the camera to the computer with the USB cable. Other devices must not be connected to the computer during this procedure.
2. Right click on the My-computer icon. Select "properties" from the drop-down menu.  
Windows XP: from the start menu go to the control panel. Click on the performance and maintenance category. Click "System" to open the system properties window.  
Windows 2000 and XP: select the hardware tab in the properties window and click the device-manager button.  
Windows 98 and Me: click the device-manager tab in the properties window.
4. The driver file will be located in the universal-serial-bus-controller or other-devices location of the device manager. Click on the locations to display the files. The driver should be indicated with the camera name. Under certain conditions, the driver name may not contain the camera name. However, the driver will be indicated by either a question mark or exclamation point.
5. Click on the driver to select it.
6. Windows 2000 and XP: click on the action button to display the drop-down menu. Select "uninstall." A confirmation screen will appear. Clicking "Yes" will remove the driver from the system.  
Windows 98 and Me: click the remove button. A confirmation screen will appear. Clicking "Yes" will remove the driver from the system.
7. Disconnect the USB cable and turn off the camera. Restart the computer.

## Disconnecting the camera from the computer

Follow the instruction below when disconnecting the camera from the computer. This procedure is also necessary before changing the memory type while the camera is connected to the computer. The appearance of screens may differ with the operating system.



Never disconnect the camera when the indicator lamp is blinking - the data or memory card may permanently be damaged.

### Windows 98 / 98 Second Edition

Confirm that the green indicator lamp is not blinking. Turn the camera off and then disconnect the USB cable.

### Windows Me, 2000 Professional, and XP



To disconnect the camera, click once on the unplug-or-eject-hardware icon located on the task bar. A small window will open indicating the device to be stopped.

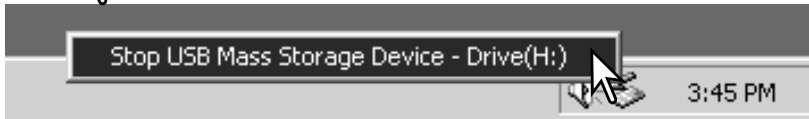

Click on the small window to stop the device. The safe-to-remove-hardware window will open. Close the window, turn the camera off, and then disconnect the USB cable.



When more than one external device are connected to the computer, repeat the procedure above except right click on the unplug-or-eject-hardware icon. This will open the unplug-or-eject-hardware window after clicking on the small window indicating the unplug-or-eject-hardware routine.



The hardware devices to be stopped will be displayed. Highlight the device by clicking on it then click "Stop."



A confirmation screen will appear to indicate the devices to be stopped. Clicking "OK" will stop the device.

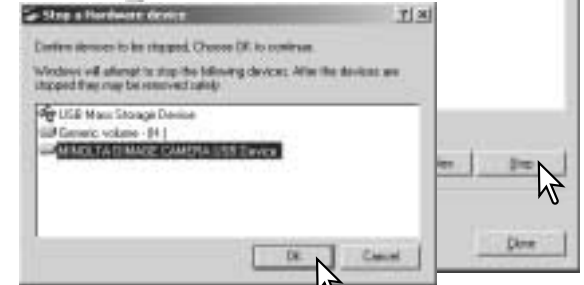

A third and final screen will appear to indicate the camera can be safely disconnected from the computer. Close the window, turn the camera off, and then disconnect the USB cable.



### Macintosh



Confirm that the green indicator lamp is not blinking and then drag the mass-storage device icon and drop it into the trash. Turn the camera off, and then disconnect the USB cable.



# APPENDIX

## Troubleshooting

The section covers minor problems with basic camera operation. For major problems or damage, or if a problem continues to reoccur frequently, contact a Minolta service facility listed on the back cover of this manual.

Problem	Cause	Solution
The camera will not work.	The battery is dead.	Replace battery (p. 11).
	AA Ni-MH batteries are exhausted.	Ni-MH batteries must be charged before use.
Memory-full message appears.	Selected memory is full and unable to store an image at the image-quality setting on the camera.	Change the memory type (p. 45), insert a new memory card (p. 16), delete some images (p. 25), or change the image-quality setting (p. 41).
Focus frame remains white and pictures are not sharp.	Subject is too close.	Make sure the subject is within the autofocus range (p. 21) or use the macro mode (p. 33).
	The camera is in macro mode.	Cancel the macro mode setting (p. 33).
	A special situation is preventing the autofocus system from focusing (p. 23).	Use the focus-lock function to focus on an object at the same distance as the subject (p. 22).
Pictures are not sharp in low-light situations.	Pictures are taken indoors or in low-light situations without flash. Slow shutter speeds result in blurred images when the camera is hand-held.	Use a tripod or use the flash (p. 26).

Problem	Cause	Solution
Monitor turns off and the orange indicator lamp blinks.	Flash is charging.	Wait until the monitor image is visible and the orange indicator lamp glows.
While using flash, the pictures are too dark.	The subject is beyond the flash range (p. 27).	Move closer to the subject.
Exposure-compensation display turns red.	Scene is too bright or dark and outside the exposure range of the camera.	Change the setting until the display is white.
No-image message appears in playback mode.	Different memory type is selected.	Select the memory type (internal memory or memory card) where the images were saved (p. 45).
Error or zoom-error message appears.	Remove and reinsert the batteries, or unplug and reconnect the AC adapter.	

If the camera does not function normally, turn it off, remove and reinsert the batteries, or unplug and reconnect the AC adapter. If the camera has become hot with extended use, wait for it to cool before removing or disconnecting the power supply. Always turn the camera off with the main switch, otherwise the memory card may be damaged and camera settings reset.

## Care and storage

Read this section in its entirety to get the best results from your camera. With proper care, your camera will provide years of service.

### Camera care

- Do not subject the camera to shock or impact.
- Turn off the camera when transporting.
- This camera is neither waterproof nor splashproof. Inserting or removing batteries or the memory card, or operating the camera with wet hands may damage the camera.
- When at the beach or near water, take care not to expose the camera to water or sand. Water, sand, dust, or salt can damage the camera.
- Do not leave the camera under direct sunlight. Do not point the lens directly at the sun; the CCD may be damaged.

### Cleaning

- If the camera or the outside of the lens is dirty, gently wipe it with a soft, clean, dry cloth. If the camera or lens comes in contact with sand, gently blow away loose particles. Wiping may scratch the surface.
- To clean the lens surface, first blow away any dust or sand, then, if necessary, moisten a lens tissue or soft cloth with lens cleaning fluid and gently wipe the lens.
- Never use organic solvents to clean the camera.
- Never touch the lens surface with your fingers.

### Storage

- Store in a cool, dry, well-ventilated area away from dust and chemicals. For long periods of disuse, store the camera in an airtight container with a silica-gel drying agent.
- Remove the batteries and memory card from the camera when not in use for extended periods.
- Do not store the camera in an area with naphthalene or mothballs.
- During long periods of storage, operate the camera occasionally. When taking the camera out of storage, check that the camera is functioning properly before using.

### Operating temperatures and conditions

- This camera has been designed for use in temperatures from 0°C to 40°C (32°F to 104°F).
- Never leave the camera exposed to extreme high temperatures, such as in a car parked in the sun, or to extreme humidity.
- When taking the camera from a cold to a warm environment, place it in a sealed plastic bag to prevent condensation from forming. Allow the camera to come to room temperature before removing it from the bag.

### Batteries

- Battery performance decreases with temperature. In cold environments, we recommend keeping spare batteries in a warm place, such as the inside of a coat. Batteries can recover their power when they warm up.
- If batteries have been exhausted when used in the camera, do not reload them even if their charge seems to recover over time. These batteries will interfere with normal camera operation.

### Copyright

- TV program, films, video tapes, photographs, and other materials may be copyrighted. Unauthorized recording or duplication of such material may be contrary to copyright laws. Taking pictures or images of performances, exhibitions, etc., is prohibited without approval and can infringe on copyright. Images protected by copyright can only be used under the provisions within the copyright laws.

### LCD monitor care

- Although the LCD monitor is manufactured using high precision technology, there may occasionally be a lack of color or bright points on the monitor.
- Do not apply pressure to the surface of the LCD monitor; it may be permanently damaged.
- In cold temperatures, the LCD monitor may become temporarily dark. When the camera warms up, the display will function normally.
- If fingerprints are on the LCD monitor surface, gently wipe with a soft, clean, dry cloth.

## About Ni-MH batteries

When using Ni-MH batteries, clean both battery terminals with dry cloth to wipe off any dirt or residue. Because of the sophisticated computer system, the camera critically monitor power levels. If the battery terminals are dirty, the camera may give a false low-battery warning. If battery performance is unusually low, wipe the battery terminals with a clean, dry cloth.

Ni-MH battery performance will decrease if the batteries are often recharged before they have been fully discharged. Completely exhaust the Ni-MH batteries using the camera before charging.

The following marks may be found on the product:



This mark on your camera certifies that this camera meets the requirements of the EU (European Union) concerning interference causing equipment regulations. CE stands for Conformité Européenne (European Conformity).

Digital Camera: DiIMAGE E223



Tested To Comply  
With FCC Standards

FOR HOME OR OFFICE USE

This device complies with Part 15 of the FCC Rules. Operation is subject to the following two conditions: (1) This device may not cause harmful interference, and (2) this device must accept any interference received, including interference that may cause undesired operation.

Do not remove the ferrite cores from the cables.

Tested by the Minolta Corporation

101 Williams Drive, Ramsey, New Jersey 07446, U.S.A.

This Class B digital apparatus complies with Canadian ICES-003.

Cet appareil numérique de la classe B est conforme à la norme NMB-003 du Canada.

## Technical specifications

Number of effective pixels:	2.0 million (approx.)
CCD:	1/2.7-type interline primary-color CCD
Camera sensitivity:	ISO 100 equivalent
Aspect ratio:	4:3
Lens construction:	9 elements in 6 groups
Focal length:	6.2 - 18.6mm (35mm equivalent: 38 - 114mm)
Maximum aperture:	f/2.9 - f/3.0
Focusing range:	Wide: 0.6m to infinity (from front of lens) Telephoto: 0.6m to infinity (from front of lens) Macro focus range: Wide: 8 - 60cm from front of lens Telephoto: 40 - 60cm from front of lens
Autofocus system:	Video AF
Shutter:	CCD electronic shutter and mechanical shutter Shutter-speed range: 1 - 1/1000s
Flash recycling time:	10s or less
Viewfinder type:	Optical real-image zoom viewfinder
Field of view:	80% (approx.)
Eye-relief:	15mm (from eyepiece)
A/D conversion:	10 bits
Recording media:	SD (Secure Digital) Memory Cards / MultiMediaCards
File formats:	JPEG, Motion JPEG (AVI, with audio) DCF1.0-compliant DPOF-compliant (supported by printing functions in ver.1.1)
Printing output control:	Exif 2.2, PRINT Image Matching II
LCD monitor:	3.8cm (1.5 inch) TFT color Total pixels: 62,000 (approx.) Field of view: 100% (approx.)
Menu languages:	English, German, French, Spanish
Movie recording:	File format: Motion JPEG (AVI) Number of recorded pixels: 320 x 240 60s (max.) at 15 fps with audio (monaural)
Batteries:	Two AA Ni-MH or alkaline batteries (use of Ni-MH batteries is recommended) Or one CR-V3 lithium battery
External power source:	3V DC (with specified AC adapter)
Battery performance (Recording):	Approximately 150 frames: based on Minolta's

standard test method: 1850mAh Ni-MH battery,  
LCD monitor on, 1600x1200 Fine, flash used with  
50% of the frames.

Computer interface: USB 1.1

AV output: NTSC, PAL (selected on the camera)

Dimensions: 106.0 (W) X 66.5 (H) X 34 (D) mm  
4.2 (W) X 2.6 (H) X 1.3 (D) in.  
(without lens section)

Weight: Approximately 200g / 7.1 oz.  
(without batteries or recording media)

Operating temperature: 0 - 40°C / 32 - 104°F

Specifications are based on the latest information available at the time of printing and are subject to change without notice.

# MINOLTA

**Minolta Co., Ltd.**

**3-13, 2-Chome, Azuchi-Machi, Chuo-Ku, Osaka 541-8556, Japan**

**Minolta Europe GmbH  
Reparatur/Repair**

Minoltaring 11, D-30855 Langenhagen, Germany  
Senator-Helmken-Strasse 1, D-28197 Bremen, Germany

**Minolta France S.A.S.**

365 Route de Saint-Germain, F-78420 Carrières-Sur-Seine, France

**Minolta (UK) Limited**

7 Tanners Drive, Blakelands, Milton Keynes, MK14 5BU, England

**Minolta Austria Ges. m.b.H.**

Amalienstrasse 59-61, A-1131 Wien, Austria

**Minolta Camera Benelux B.V.**

Zonnebaan 39, P.O. Box 6000, NL-3600 HA Maarssen, The Netherlands

**Belgian Branch**

Prins Boudewijnlaan 1, B-2550 Kontich, Belgium

**Minolta (Schweiz) AG**

Riedstrasse 6, CH-8953 Dietikon, Switzerland

**Minolta Svenska AB**

Albygatan 114, S-171 54 Solna, Sweden

**Finnish Branch**

Niittykatu 6 PL 37, SF-02201 Espoo, Finland

**Minolta Portugal Limitada**

Av. do Brasil 33-A, P-1700 Lisboa, Portugal

**Minolta Corporation**

101 Williams Drive, Ramsey, New Jersey 07446, U.S.A.

**Minolta Canada Inc.**

369 Britannia Road East, Mississauga, Ontario L4Z 2H5, Canada

**Minolta Hong Kong Limited**

Room 208, 2/F, Eastern Center, 1065 King's Road, Quarry Bay, Hong Kong

**Minolta Singapore (Pte) Ltd.**

10, Teban Gardens Crescent, Singapore 608923

**Shanghai Minolta Optical**

**Products Co., Ltd.**

368 Minolta Road, Songjiang, Shanghai, China

© 2003 Minolta Co., Ltd. under the Berne Convention  
and the Universal Copyright Convention.



9222-2727-11 PM-A303  
Printed in China

ご使用前にお読みください

SPECIAL NOTICE

NOTE SPÉCIALE

AVISO ESPECIAL

WICHTIGER HINWEIS

AVVERTENZE SPECIALI

SPECIALINFORMATION

BEMÆRK

SPECIALE AANWIJZINGEN

ERITYISMUISTUTUS

特別注意事項

NiMH&Lith/Alkl  
Minolta. Co., Ltd.

9229-2727-21 PM-A303  
Printed in China

日本語

## 使用電池について

撮影には、ニッケル水素電池またはリチウム電池のご使用をおすすめします。本製品にはアルカリ電池を同梱しておりますが、アルカリ電池はその特性上、急激に電池容量が低下します。通常の撮影にはニッケル水素電池、リチウム電池、または別売りのACアダプターをお使いいただき、アルカリ電池は動作確認・テスト用や緊急時のみの使用に限られることをおすすめします。

すぐに電池が消耗する場合は

電池の種類に関わらず、電池の+ / - 両極端が汚れていると接触が悪くなり、すぐに電池が使えなくなる場合があります。新品電池でも汚れにより接触が悪くなっていることがありますので、すぐに電池が消耗する場合は、電池の両極端を乾いた布でよく拭いてからお使いください。

ニッケル水素電池は使い切ってから充電を

ニッケル水素電池には「メモリー効果」という現象があり、十分に使い切らないうちに充電を繰り返すと、完全に充電されたように見えても実際の容量は徐々に少なくなっていきます。電池容量がなくなるまで使い切ってから、充電を行なうことをおすすめします。

電池の性能について

電池の性能(連続動作時間・撮影可能コマ数)については、使用説明書の「主な性能」をご覧ください。

Deutsch

## ENERGIEVERBRAUCH VON DIGITALKAMERAS

Verwenden Sie in Ihrer Digitalkamera NiMH-Akkus (Nickel-Metall-Hydrid). Mit NiMH-Akkus oder Lithium-Batterien erzielen Sie eine bessere Leistung als bei Verwendung von Alkali-Batterien.

Detaillierte Informationen zum Stromverbrauch Ihrer Kamera finden Sie im Kapitel „Technische Daten“ der PDF-Bedienungsanleitung.

Die Angaben zur Anzahl der maximal möglichen Aufnahmen sind abhängig vom Hersteller und Typ des Ladegerätes und der Akkus, sowie von den Betriebsbedingungen und können variieren.

Die mitgelieferten Alkali-Batterien sollten daher nur für eine erste Funktionsüberprüfung verwendet werden. Im praktischen Einsatz sollten NiMH-Akkus, das externe Powerpack (EBP-100) oder ein Netzgerät eingesetzt werden. NiMH-Akkus müssen vor dem Einsatz in der Kamera voll geladen werden (Bitte beachten Sie die Hinweise des Akku-Herstellers bzw. Ladegerät-Herstellers).

Reinigen Sie alle Kontakte an Akkus und Kamera vor dem Einsetzen mit einem weichen, sauberen und trockenen Tuch. Bei einer Verschmutzung der Batteriekontakte kann es dazu kommen, dass die Batteriezustands-Anzeige eine schwache Batterieladung anzeigt obwohl die Akkus voll geladen sind. Falls die Akkuleistung ungewöhnlich niedrig sein sollte, reinigen Sie die Kontakte der Kamera und der Akkus bevor Sie die frisch geladenen Akkus einsetzen.

Die Kapazität der NiMH-Akkus kann im Laufe der Zeit abnehmen, wenn sie vor dem erneuten Laden nicht vollständig entladen werden. Entladen Sie daher die Akkus vor dem Aufladen vollständig mithilfe eines speziellen Ladegerätes oder der Kamera. Schalten Sie die Kamera immer aus, bevor Sie die Akkus/Batterien wechseln.

English

## ABOUT CAMERA BATTERIES

Ni-MH or lithium batteries are recommended over alkaline for digital cameras. Battery performance with this camera is described in the technical specifications section of the instruction manual. The number of recordable frames can vary with battery and charger brands, and under differing operating conditions.

Although alkaline batteries are supplied with this product, its performance will be limited; only use alkaline batteries for test photographs or when the recommended battery type or AC adapter are not available.

When inserting batteries, clean both battery terminals with a dry cloth to wipe off any dirt or residue. Because of the sophisticated computer system, the camera critically monitors power levels. If the battery terminals are dirty, the camera may give a false low-battery warning. If battery performance is unusually low, first wipe the battery terminals with a clean, dry cloth before replacing the batteries.

Ni-MH battery performance will decrease if the batteries are often recharged before they have been fully discharged. Completely exhaust the Ni-MH batteries using the camera before charging. Always turn off the camera before changing the batteries.

Français

## A PROPOS DES PILES / BATTERIES DES APPAREILS

Les batteries Ni-MH ou les piles lithium sont recommandées pour les appareils numériques au lieu des piles alcalines. L'autonomie et la capacité d'enregistrement de cet appareil sont spécifiées dans le chapitre "Caractéristiques techniques" du mode d'emploi de l'appareil. Le nombre d'images enregistrables peut varier en fonction de la marque des batteries ou des conditions de prise de vue.

Avec le jeu de piles alcalines fournies, les performances seront très limitées. Utiliser les piles alcalines uniquement pour quelques essais ou si les piles, les batteries ou l'adaptateur secteur qui sont recommandés ne sont pas disponibles.

Lors de l'insertion des piles ou des batteries, nettoyer à l'aide d'un tissu propre et sec les deux contacts des accumulateurs afin de retirer poussières et saletés résiduelles. La complexité du système numérique nécessite un seuil de tension minimal critique. Si les contacts des batteries/piles sont sales, l'appareil peut l'interpréter comme un signal de tension insuffisante. Si les performances sont anormalement faibles, nettoyer les contacts avec un tissu propre et sec.

La performance des batteries Ni-MH décroît si elles sont souvent rechargées avant leur décharge complète. Utiliser à fond les batteries avant de les recharger. Toujours éteindre l'appareil avant de remplacer les batteries.

Español

## ACERCA DE LAS PILAS DE LA CÁMARA

Recomendamos usar las pilas de litio o Ni-MH en lugar de las pilas alcalinas en las cámaras digitales. El rendimiento de las pilas con esta cámara se describe en la sección de especificaciones técnicas del manual de instrucciones. El número de fotogramas grabables puede variar dependiendo de la marca de la pila y del cargador, y según las distintas condiciones de funcionamiento.

Aunque se proporcionan pilas alcalinas con este producto, su uso es limitado; utilice sólo las pilas alcalinas cuando vaya a realizar fotografías de prueba o cuando el tipo de pila recomendado o adaptador de corriente AC no estén disponibles.

Cuando coloque las pilas, limpie ambas terminales de la pila con un trapo seco para retirar cualquier resto de suciedad o residuos. Debido a un sofisticado sistema informático, la cámara monitoriza críticamente los niveles de carga de la pila. Si las terminales de la pila están sucias, la cámara puede dar una falsa advertencia de carga insuficiente. Si el rendimiento de las pilas es inusualmente bajo, limpie primero los polos de la misma con un paño limpio y seco antes de cambiarlas.

El rendimiento de las pilas Ni-MH disminuirá si se recargan con frecuencia, antes de que se hayan gastado por completo. Agote completamente las pilas Ni-MH utilizando la cámara, antes de cargarlas. Apague siempre la cámara antes de cambiar las pilas.

Italiano

## AVVERTENZE SULLE PRESTAZIONI DELLE BATTERIE

Con fotocamere digitali è consigliato l'uso di batterie Ni-MH o al Litio. Le prestazioni delle batterie con questa fotocamera sono specificate nella sezione delle caratteristiche tecniche del libretto istruzioni della fotocamera stessa. Il numero dei fotogrammi memorizzabili può variare in relazione al tipo delle batterie, del charger ed alle diverse condizioni operative.

Questo apparecchio è fornito, all'acquisto, di batterie alcaline che, pur consentendone un corretto utilizzo, garantiscono tuttavia prestazioni limitate; per questo motivo vi consigliamo di utilizzare le batterie alcaline per effettuare fotografie di prova o quando non sono disponibili le batterie del tipo raccomandato o l'alimentatore a rete AC.

Quando inserite le batterie, pulite entrambi i terminali della batteria con un panno asciutto e pulito per eliminare eventuali particelle o residui di sporco. A causa del suo sofisticato sistema computerizzato, la fotocamera è particolarmente sensibile ai livelli di alimentazione. Se i terminali della batteria sono sporchi, la fotocamera può segnalare una falsa avvertenza di scarsa alimentazione. Se le prestazioni delle batterie risultano particolarmente ridotte, pulite i terminali delle batterie con un panno pulito e asciutto prima di reinserirle nella fotocamera.

Le prestazioni delle batterie Ni-MH diminuiscono in caso di ripetute ricariche prima del completo esaurimento della carica. Fate attenzione a esaurire completamente la carica delle batterie prima di procedere alla loro ricarica. Spegnete sempre la fotocamera prima di sostituire le batterie.

Svenska

## OM BATTERIER FÖR KAMEROR

Ni-MH- eller litiumbatterier rekommenderas istället för alkaline-batterier till digitalkameror. Batteriets/batteriernas prestanda i denna kamera beskrivs i bruksanvisningens tekniska data. Det antal bilder som kan exponeras kan variera beroende på batteri- och laddarfabrikat samt på olika arbets- och tagnings-förhållanden.

Fastän alkalinebatterier levereras med denna produkt, kommer dess prestanda att vara begränsade; använd bara alkaline-batterier för testbilder eller när den rekommenderade batteritypen eller AC-adaptern inte är tillgängliga.

När batterier skall sättas i, rengör batteriernas båda poler med en ren trasa för att torka av allt smuts eller kvarvarande materia. Tack vare det avancerade datorsystemet, känner kameran kritiskt av effektnivåerna. Om batteriernas poler blivit smutsiga, kan kameran kanske ge en felaktig varning för svaga batterier. Om batteriernas prestanda är ovanligt dåliga, torka av batteriernas poler med en ren och torr trasa.

Ni-MH-batteriernas prestanda kommer att försvagas om batterierna laddats upp ofta innan de har laddats ur fullständigt. Kör totalt slut på Ni-MH-batterierna med kamerans hjälp innan de laddas upp på nytt. Stäng alltid av kameran innan batterierna byts ut.

Dansk

## OM KAMERABATTERIER

Ni-MH eller litiumbatterier er bedre egnet til digitalkameraer end alkaliske batterier. Batterikapaciteten med dette kamera fremgår af de tekniske specifikationer i betjeningsvejledningen. Antallet af optagelser kan variere, afhængigt af hvilket mærke af batterier og oplader, du benytter, og brugsforholdene.

De medfølgende alkaliske batteriers kapacitet er begrænset. Brug kun alkaliske batterier, hvis du ikke har adgang til en anbefalet batteritype eller en AC adapter.

Ved isætning af batterier: Aftør begge batteripoler med en tør klud, så de er helt rene. Kameraet kontrollerer løbende batterikapaciteten, og hvis der er dårlig kontakt, kan du få en forkert meddelelse om lav batterikapacitet. Hvis batterikapaciteten er usædvanlig lav: Prøv først at rense alle kontaktflader med en ren, tør klud, inden du udskifter batterierne.

Ni-MH batteriers ydeevne falder, hvis de ofte oplades, inden de er fuldt afladede. Brug helst batterierne i kameraet, til de er fuldt afladede, inden du oplader dem. Husk altid at slukke kameraet, inden du oplader batterierne.

Nederlands

## INFORMATIE OVER DE VOEDING VAN DE CAMERA

Voor de voeding van digitale camera's wordt het gebruik van Ni-MH accu's of lithium batterijen sterk aanbevolen. Deze functioneren langer dan alkaline batterijen. De opname-prestaties van deze camera, bij gebruik van een bepaalde voeding, staan vermeld in de technische specificaties van de gebruiksaanwijzing. Het werkelijk aantal op te nemen beelden is uiteraard mede afhankelijk van de opname- omstandigheden, het accutype en de totale tijd dat de camera (en dan met name de LCD monitor) ingeschakeld staat.

Hoewel de camera met alkaline batterijen wordt geleverd, zijn de prestaties daarvan nogal beperkt. Wij adviseren u dan ook deze batterijen uitsluitend te gebruiken voor een eerste kennismaking met de camera, of wanneer de hierboven aanbevolen accu's of de Minolta Lichtnet-adapter niet beschikbaar zijn.

Reinig bij inzetten van de accu's altijd alle polen daarvan, en ook de contacten van de camera, met een schone en droge doek, om mogelijke aanslag of vuil te verwijderen. Het geavanceerde computersysteem van de camera houdt het batterijniveau namelijk kritisch in de gaten. Zijn de batterijcontacten vuil geworden, dan kan het zijn dat de camera op basis daarvan een (valse) melding voor te lage batterijspanning geeft. Ziet u onverwachts zo'n waarschuwing, reinig dan (opnieuw) de batterij-contacten zoals aangegeven.

Nieuwe Ni-Mh accu's geven hun optimale prestaties pas nadat deze een aantal keren volledig geladen en ontladen zijn. De prestaties van Ni-MH accu's kunnen teruglopen wanneer deze vaak zijn geladen voordat ze volledig ontladen waren. Het is daarom raadzaam de accu's altijd eerst volledig te ontladen en daarna pas weer op te laden. Let op dat de camera is uitgeschakeld voordat u de batterijen verwisselt. Het is overigens raadzaam om Ni-MH accu's volledig op te laden vlak voor het gebruik van de camera (let ook op de oplaadtijd).

Suomi

## KAMERAN AKUT JA PARISTOT

Ni-MH akkuja tai litiumparistoa suositellaan digitaalikameroihin alkaaliparistojen sijasta. Akkujen ja pariston riittoisuus tässä kamerassa selostetaan käyttöohjeen teknisissä tiedoissa. Kuvien määrä voi vaihdella pariston / akkujen ja laturin merkin mukaan sekä poikkeavissa käyttöolosuhteissa.

Vaikka kameran mukana tulee alkaaliparistot, niiden riittoisuus on hyvin rajallinen. Käytä alkaaliparistoja vain koekuviin tai kun määriteltyä paristoa. Ni-MH akkuja tai AC adapteria ei ole käytettävissä.

Kun laitat pariston tai akut kameraan, puhdista niiden navat liasta ja jäämistä käyttäen kuivaa kangasta. Hienoviritteisestä tietokonejärjestelmästä johtuen kamera tarkkailee varauksen määrää kriittisesti. Jos akkujen navat ovat likaiset, kamera voi antaa virheellisen varoituksen virran vähäisyydestä. Jos akkuteho on epätavallisen heikko, pyyhi akkujen navat kuivalla, puhtaalla kankaalla ennen kuin asetat ne uudelleen kameraan.

Ni-MH akkujen varauskyky heikkenee, jos akut ladataan usein ennen kuin ne ovat täysin tyhjentyneet. Tyhjennä Ni-MH akut aina kokonaan kameran avulla ennen kuin lataat niitä. Sammuta kamera aina ennen kuin vaihdat akkuja.

中文

## 有關相機電池

建議數碼相機使用Ni-MH或鋰電池取代鹼性電池。有關配合本相機使用的電池表現內容，操作指示手冊的技術規格部分會加以說明。可拍攝的影像數目亦會根據操作情況而有所不同。

雖然本產品附送鹼性電池，但本產品的表現卻會因使用鹼性電池而受到限制。鹼性電池只適用於測試照片，或當沒有提供建議使用的電池類型或AC交流電轉接器時使用。

當安裝電池時，請使用乾布抹去電池端子上的污垢或塵埃。因為精密的電腦系統，相機主要負責監察電量情況。若電池端子不潔時，相機會出現錯誤的低電量警告。若電池表現不尋常地降低，請在更換電池前，先以潔淨的乾布輕輕抹拭電池端子。

若Ni-MH電池經常在沒有完全放電的情況下進行充電，電池的表現會因此而下降。在充電前，必須使用相機將Ni-MH電池的電量完全耗盡。在更換電池前，必須把相機關掉。

Minolta DiMAGE E223

## About the DiMAGE Viewer

The flicker and image-correction functions on the correction menu in the Movie Enhancer cannot be used with Movie files captured with the DiMAGE E223. A computer system error will occur.

Minolta Co., Ltd.

9229-2727-22 PM-A304