

**ONKYO®**

**AV Receiver**

***TX-SR705***

**AV Amplifier**

***TX-SA705***

**Instruction Manual**

Thank you for purchasing an Onkyo AV Receiver/  
AV Amplifier. Please read this manual thoroughly  
before making connections and plugging in the unit.  
Following the instructions in this manual will enable  
you to obtain optimum performance and listening  
enjoyment from your new AV Receiver/  
AV Amplifier.  
Please retain this manual for future reference.

## Contents

**Introduction.....2**

**Connections.....21**

**First Time Setup .....45**

**Basic Operations .....59**

**Advanced Operations.....75**

**Advanced Setup.....76**

**Zone 2 .....99**

**Controlling Other Components ..104**

**Specifications .....109**

**Troubleshooting.....110**

**WARNING:**

TO REDUCE THE RISK OF FIRE OR ELECTRIC SHOCK, DO NOT EXPOSE THIS APPARATUS TO RAIN OR MOISTURE.

**CAUTION:**

TO REDUCE THE RISK OF ELECTRIC SHOCK, DO NOT REMOVE COVER (OR BACK). NO USER-SERVICEABLE PARTS INSIDE. REFER SERVICING TO QUALIFIED SERVICE PERSONNEL.



**WARNING**  
RISK OF ELECTRIC SHOCK  
DO NOT OPEN

**AVIS**  
RISQUE DE CHOC ELECTRIQUE  
NE PAS OUVRIR



The lightning flash with arrowhead symbol, within an equilateral triangle, is intended to alert the user to the presence of uninsulated "dangerous voltage" within the product's enclosure that may be of sufficient magnitude to constitute a risk of electric shock to persons.



The exclamation point within an equilateral triangle is intended to alert the user to the presence of important operating and maintenance (servicing) instructions in the literature accompanying the appliance.

## Important Safety Instructions

1. Read these instructions.
2. Keep these instructions.
3. Heed all warnings.
4. Follow all instructions.
5. Do not use this apparatus near water.
6. Clean only with dry cloth.
7. Do not block any ventilation openings. Install in accordance with the manufacturer's instructions.
8. Do not install near any heat sources such as radiators, heat registers, stoves, or other apparatus (including amplifiers) that produce heat.
9. Do not defeat the safety purpose of the polarized or grounding-type plug. A polarized plug has two blades with one wider than the other. A grounding type plug has two blades and a third grounding prong. The wide blade or the third prong are provided for your safety. If the provided plug does not fit into your outlet, consult an electrician for replacement of the obsolete outlet.
10. Protect the power cord from being walked on or pinched particularly at plugs, convenience receptacles, and the point where they exit from the apparatus.
11. Only use attachments/accessories specified by the manufacturer.
12. Use only with the cart, stand, tripod, bracket, or table specified by the manufacturer, or sold with the apparatus. When a cart is used, use caution when moving the cart/apparatus combination to avoid injury from tip-over.
 

PORTABLE CART WARNING



S3125A
13. Unplug this apparatus during lightning storms or when unused for long periods of time.
14. Refer all servicing to qualified service personnel. Servicing is required when the apparatus has been damaged in any way, such as power-supply cord or plug is damaged, liquid has been spilled or objects have fallen into the apparatus, the apparatus has been exposed to rain or moisture, does not operate normally, or has been dropped.
15. Damage Requiring Service
 

Unplug the apparatus from the wall outlet and refer servicing to qualified service personnel under the following conditions:

  - A. When the power-supply cord or plug is damaged,
  - B. If liquid has been spilled, or objects have fallen into the apparatus,
  - C. If the apparatus has been exposed to rain or water,
  - D. If the apparatus does not operate normally by following the operating instructions. Adjust only those controls that are covered by the operating instructions as an improper adjustment of other controls may result in damage and will often require extensive work by a qualified technician to restore the apparatus to its normal operation,
  - E. If the apparatus has been dropped or damaged in any way, and
  - F. When the apparatus exhibits a distinct change in performance this indicates a need for service.
16. Object and Liquid Entry
 

Never push objects of any kind into the apparatus through openings as they may touch dangerous voltage points or short-out parts that could result in a fire or electric shock.

The apparatus shall not be exposed to dripping or splashing and no objects filled with liquids, such as vases shall be placed on the apparatus.

Don't put candles or other burning objects on top of this unit.
17. Batteries
 

Always consider the environmental issues and follow local regulations when disposing of batteries.
18. If you install the apparatus in a built-in installation, such as a bookcase or rack, ensure that there is adequate ventilation.
 

Leave 20 cm (8") of free space at the top and sides and 10 cm (4") at the rear. The rear edge of the shelf or board above the apparatus shall be set 10 cm (4") away from the rear panel or wall, creating a flue-like gap for warm air to escape.

# Precautions

1. **Recording Copyright**—Unless it's for personal use only, recording copyrighted material is illegal without the permission of the copyright holder.
2. **AC Fuse**—The AC fuse inside the unit is not user-serviceable. If you cannot turn on the unit, contact your Onkyo dealer.
3. **Care**—Occasionally you should dust the unit all over with a soft cloth. For stubborn stains, use a soft cloth dampened with a weak solution of mild detergent and water. Dry the unit immediately afterwards with a clean cloth. Don't use abrasive cloths, thinners, alcohol, or other chemical solvents, because they may damage the finish or remove the panel lettering.

## 4. Power

### WARNING

BEFORE PLUGGING IN THE UNIT FOR THE FIRST TIME, READ THE FOLLOWING SECTION CAREFULLY.

AC outlet voltages vary from country to country. Make sure that the voltage in your area meets the voltage requirements printed on the unit's rear panel (e.g., AC 230 V, 50 Hz or AC 120 V, 60 Hz).

The power cord plug is used to disconnect this unit from the AC power source. Make sure that the plug is readily operable (easily accessible) at all times.

### For North American model

Pressing the [STANDBY/ON] button to select Standby mode does not fully shutdown the unit. If you do not intend to use the unit for an extended period, remove the power cord from the AC outlet.

5. **Never Touch this Unit with Wet Hands**—Never handle this unit or its power cord while your hands are wet or damp. If water or any other liquid gets inside this unit, have it checked by your Onkyo dealer.
6. **Handling Notes**
  - If you need to transport this unit, use the original packaging to pack it how it was when you originally bought it.
  - Do not leave rubber or plastic items on this unit for a long time, because they may leave marks on the case.
  - This unit's top and rear panels may get warm after prolonged use. This is normal.
  - If you do not use this unit for a long time, it may not work properly the next time you turn it on, so be sure to use it occasionally.

## For U.S. models

### FCC Information for User

#### CAUTION:

The user changes or modifications not expressly approved by the party responsible for compliance could void the user's authority to operate the equipment.

#### NOTE:

This equipment has been tested and found to comply with the limits for a Class B digital device, pursuant to Part 15 of the FCC Rules. These limits are designed to provide reasonable protection against harmful interference in a residential installation.

This equipment generates, uses and can radiate radio frequency energy and, if not installed and used in accordance with the instructions, may cause harmful interference to radio communications. However, there is no guarantee that interference will not occur in a particular installation. If this equipment does cause harmful interference to radio or television reception, which can be determined by turning the equipment off and on, the user is encouraged to try to correct the interference by one or more of the following measures:

- Reorient or relocate the receiving antenna.
- Increase the separation between the equipment and receiver.
- Connect the equipment into an outlet on a circuit different from that to which the receiver is connected.
- Consult the dealer or an experienced radio/TV technician for help.

## For Canadian Models

**NOTE:** THIS CLASS B DIGITAL APPARATUS COMPLIES WITH CANADIAN ICES-003.

For models having a power cord with a polarized plug:

**CAUTION:** TO PREVENT ELECTRIC SHOCK, MATCH WIDE BLADE OF PLUG TO WIDE SLOT, FULLY INSERT.

## Modèle pour les Canadien

**REMARQUE:** CET APPAREIL NUMÉRIQUE DE LA CLASSE B EST CONFORME À LA NORME NMB-003 DU CANADA.

Sur les modèles dont la fiche est polarisée:

**ATTENTION:** POUR ÉVITER LES CHOCS ÉLECTRIQUES, INTRODUIRE LA LAME LA PLUS LARGE DE LA FICHE DANS LA BORNE CORRESPONDANTE DE LA PRISE ET POUSSER JUSQU' AU FOND.

## Precautions—Continued

### For British models

Replacement and mounting of an AC plug on the power supply cord of this unit should be performed only by qualified service personnel.

#### IMPORTANT

The wires in the mains lead are coloured in accordance with the following code:

Blue: Neutral

Brown: Live

As the colours of the wires in the mains lead of this apparatus may not correspond with the coloured markings identifying the terminals in your plug, proceed as follows:

The wire which is coloured blue must be connected to the terminal which is marked with the letter N or coloured black.

The wire which is coloured brown must be connected to the terminal which is marked with the letter L or coloured red.

#### IMPORTANT

The plug is fitted with an appropriate fuse. If the fuse needs to be replaced, the replacement fuse must be approved by ASTA or BSI to BS1362 and have the same ampere rating as that indicated on the plug. Check for the ASTA mark or the BSI mark on the body of the fuse.

If the power cord's plug is not suitable for your socket outlets, cut it off and fit a suitable plug. Fit a suitable fuse in the plug.

### For European Models

Declaration of Conformity	
We, ONKYO EUROPE ELECTRONICS GmbH LIEGNITZERSTRASSE 6, 82194 GROEBENZELL, GERMANY	
declare in own responsibility, that the ONKYO product described in this instruction manual is in compliance with the corresponding technical standards such as EN60065, EN55013, EN55020 and EN61000-3-2, -3-3.	
GROEBENZELL, GERMANY	 K. MIYAGI
ONKYO EUROPE ELECTRONICS GmbH	

# Supplied Accessories

Make sure you have the following accessories:

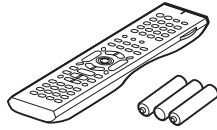

**Remote controller & three batteries (AA/R6)**

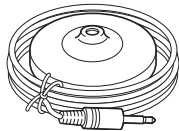

**Speaker setup microphone**

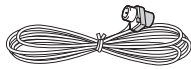

**Indoor FM antenna (TX-SR705 only)**

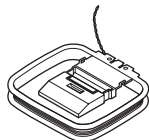

**AM loop antenna (TX-SR705 only)**

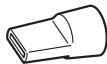

**Speaker terminal tool**

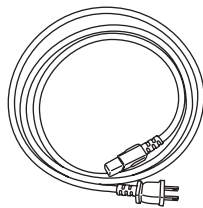

**Power cord (not North American models)  
(Plug type varies from country to country.)**

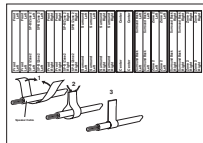

**Speaker cable labels**

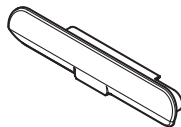

**AUX protection cap (European models only)**  
This cap is used to protect the AUX INPUT jack. When the AUX INPUT jack is not used, install this cap to the jack.

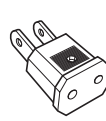

**Power-plug adapter**

Only supplied in certain countries. Use this adapter if your AC outlet does not match with the plug on the AV receiver/AV amplifier's power cord (adapter varies from country to country).

**\*How to mount the AC plug:**

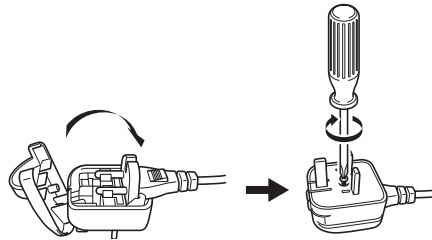

\* In catalogs and on packaging, the letter at the end of the product name indicates the color. Specifications and operations are the same regardless of color.

# Features

## Amplification

- 100 watts minimum continuous power per channel, 8 ohm loads, 2 channels driven from 20 Hz to 20 kHz with a maximum total harmonic distortion of 0.08 % (FTC rating)
- WRAT-Wide Range Amplifier Technology (5 Hz-100 kHz bandwidth)
- Optimum Gain Volume Circuitry

## Processing

- THX Select2<sup>\*1</sup> Certified
- HDMI Video Upconversion with TBC
- Dolby<sup>\*2</sup> Digital Plus, Dolby TrueHD
- DTS<sup>\*3</sup>-HD High Resolution Audio, DTS-HD Master Audio
- Faroudja DCDi Edge Enhancement
- Neural THX Surround<sup>\*4</sup> Decoder
- Non-Scaling Configuration
- A-Form Listening Mode Memory
- Direct Mode and Pure Audio Mode
- 192 kHz/24-bit D/A Converters
- Powerful and Highly Accurate 32-bit DSP Processing x 3

## Connections

- 3 HDMI<sup>\*5</sup> Inputs and 1 Output (ver. 1.3a)
- 6 Digital Inputs (3 Optical / 3 Coaxial) / 1 Output (Optical)
- 5 S-Video Inputs / 2 Outputs
- Color-Coded Banana Plug-Compatible Speaker Posts
- Color-Coded 7.1 Multichannel Inputs and Pre Outs
- Powered Zone 2
- IR Input and 12 V Trigger
- RS232 Port for Interface Control
- Bi-Amp Connectable for FL/FR with SBL/SBR

## Miscellaneous

- SIRIUS Ready<sup>\*6</sup> / XM Ready<sup>\*7</sup> with XMHD Surround (North American models only)
- 40 SIRIUS/XM/AM/FM Presets (North American models)
- 40 AM/FM Presets (European and Asian models)
- Audyssey MultEQ XT<sup>\*8</sup> to Correct Room Acoustic Problems
- Crossover Adjustment (40/50/60/70/80/90/100/120/150/200 Hz)
- A/V Sync Control Function (up to 250 ms)
- New Graphic On-Screen Display
- Compatible with RI Dock for iPod
- Aluminum Front Panel
- Backlit/Preprogrammed RI-Compatible Remote with 3 Macros and Mode-Key LEDs

\*1.  THX and Select2 are trademarks of THX Ltd. THX may be registered in some jurisdictions. All rights reserved. Surround EX is a trademark of Dolby Laboratories. Used with permission.

\*2.  Manufactured under license from Dolby Laboratories. "Dolby", "Pro Logic" and the double-D symbol are trademarks of Dolby Laboratories.

\*3.  "DTS" is a registered trademark of DTS, Inc. and "DTS-HD Master Audio" is a trademark of DTS, Inc.

 "DTS" and "DTS-ES 1 Neo: 6" are registered trademarks of DTS, Inc. "96/24" is a trademark of DTS, Inc.

\*4.  Neural Surround is a trademark owned by Neural Audio Corporation, THX is a trademark of THX Ltd., which may be registered in some jurisdictions. All rights reserved.

\*5.  HDMI, the HDMI logo and High Definition Multimedia Interface are trademarks or registered trademarks of HDMI Licensing, LLC.

\*6.  ©2005 SIRIUS Satellite Radio Inc. "SIRIUS," SiriusConnect, the SIRIUS dog logo, channel names and logos are trademarks of SIRIUS Satellite Radio Inc. Available only in the contiguous United States (excluding Alaska and Hawaii) and Canada.

\*7.  XM Ready<sup>®</sup> is a registered trademark of XM Satellite Radio Inc. ©2005 XM Satellite Radio Inc. All rights reserved.

\*8.  Manufactured under license from Audyssey Laboratories. U.S. and foreign patents pending. Audyssey MultEQ<sup>®</sup> XT is a trademark of Audyssey Laboratories.

### THX Select2

Before any home theater component can be THX Select2 certified, it must pass a rigorous series of quality and performance tests. Only then can a product feature the THX Select2 logo, which is your guarantee that the Home Theater products you purchase will give you superb performance for many years to come. THX Select2 requirements define hundreds of parameters, including power amplifier performance, and pre-amplifier performance and operation for both digital and analog domains. THX Select2 receivers also feature proprietary THX technologies (e.g., THX Mode) which accurately translate movie soundtracks for home theater playback.

\* "Xantech" is a registered trademark of Xantech Corporation.  
 \* "Niles" is a registered trademark of Niles Audio Corporation.  
 \* Apple and iPod are trademarks of Apple, Inc., registered in the U.S. and other countries.

This product incorporates copyright protection technology that is protected by U.S. patents and other intellectual property rights. Use of this copyright protection technology must be authorized by Macrovision Corporation, and is intended for home and other limited consumer uses only unless otherwise authorized by Macrovision. Reverse engineering or disassembly is prohibited.

# Table of Contents

<b>Introduction</b>		<b>Basic Operations</b>	
<b>Important Safety Instructions</b> .....	<b>2</b>	<b>Basic Operations</b> .....	<b>59</b>
<b>Precautions</b> .....	<b>3</b>	Selecting the Input Source .....	59
<b>Supplied Accessories</b> .....	<b>5</b>	Using the Multichannel DVD Input .....	60
<b>Features</b> .....	<b>6</b>	Adjusting the Bass & Treble .....	60
<b>Front &amp; Rear Panels</b> .....	<b>10</b>	Displaying Source Information .....	60
Front Panel .....	10	Setting the Display Brightness .....	61
Display .....	12	Muting the AV receiver/AV amplifier .....	61
Rear Panel .....	13	Using the Sleep Timer .....	61
<b>Remote Controller</b> .....	<b>14</b>	Using Headphones .....	61
Installing the Batteries .....	14	<b>Listening to the Radio (TX-SR705 only) ...</b>	<b>62</b>
Aiming the Remote Controller .....	14	Using the Tuner .....	62
Using the Remote Controller .....	15	Presetting AM/FM Stations .....	63
RECEIVER/TAPE Mode .....	15	Using RDS (European models only) .....	64
DVD Mode .....	17	<b>Using the Listening Modes</b> .....	<b>66</b>
CD/MD/CDR Modes .....	18	Selecting Listening Modes .....	66
DOCK Mode .....	19	Listening Modes Available for Each Source	
<b>About Home Theater</b> .....	<b>20</b>	Format .....	67
Enjoying Home Theater .....	20	About the Listening Modes .....	71
<b>Connections</b>		<b>Recording</b> .....	<b>74</b>
<b>Connecting the AV Receiver/AV Amplifier</b> ..	<b>21</b>	<b>Advanced Operations</b>	
About AV Connections .....	21	<b>Advanced Operations</b> .....	<b>75</b>
Connecting Your Speakers .....	22	Using the Late Night Function (Dolby Digital,	
Bi-amping the Front Speakers .....	24	Dolby Digital Plus, and Dolby TrueHD only)	75
Connecting Antenna (TX-SR705 only) .....	25	Using the Re-EQ Function .....	75
Connecting Both Audio & Video .....	27	Adjusting Individual Speaker Levels .....	75
Which Connections Should I Use? .....	27	<b>Advanced Setup</b>	
Connecting a TV or Projector .....	29	<b>Advanced Setup</b> .....	<b>76</b>
Connecting a DVD Player .....	30	About the Onscreen Setup Menus .....	76
Connecting a VCR or DVD Recorder for		Speaker Setup .....	77
Playback .....	32	Multichannel DVD Input Settings .....	84
Connecting a VCR or DVD Recorder for		Audio Adjust Functions .....	85
Recording .....	33	Assigning Listening Modes to Input Sources ..	87
Connecting a Satellite, Cable, Set-top box, or		Source Setup .....	88
Other Video Source .....	34	Volume Setup/OSD Setup .....	92
Connecting a Game Console .....	35	Changing the AV Receiver/AV Amplifier's ID ..	94
Connecting a Camcorder or Other Device ...	36	HDMI Setup .....	95
Connecting Components with HDMI .....	37	Lock Setup .....	97
Connecting a CD Player or Turntable .....	39	Digital Input Signal Formats .....	97
Connecting a Cassette, CDR, MiniDisc, or		Changing the Remote Controller's ID .....	98
DAT Recorder .....	40	<b>Zone 2</b>	
Connecting a Power Amplifier .....	41	<b>Zone 2</b> .....	<b>99</b>
Connecting a Tuner (TX-SA705 only) .....	41	Connecting Zone 2 .....	99
Connecting an RI Dock .....	42	Setting the Powered Zone 2 .....	100
Connecting the Power Cords of Other Components		Using Zone 2 .....	101
(North American and European models only)	42	Using the Remote Controller in Zone 2 and	
Connecting Onkyo <b>RI</b> Components .....	43	Multiroom Control Kits .....	103
Connecting the RS232 Port .....	43	<b>Controlling Other Components</b>	
Connecting the Power Cord .....	43	<b>Controlling Other Components</b> .....	<b>104</b>
<b>Turning On the AV Receiver/AV Amplifier</b> ..	<b>44</b>	Entering Remote Control Codes .....	104
Turning On and Standby .....	44	Remote Control Codes for Onkyo	
<b>First Time Setup</b>		Components Connected via <b>RI</b> .....	105
<b>First Time Setup</b> .....	<b>45</b>	Resetting REMOTE MODE Buttons .....	105
Using the Onscreen Setup Menus .....	45	Resetting the Remote Controller .....	105
Speaker Settings .....	46	Learning Commands .....	107
HDMI Monitor Setup .....	47	Using Macros .....	108
Video Input Setup .....	48	<b>Others</b>	
Changing the Input Display .....	50	<b>Specifications</b> .....	<b>109</b>
Digital Input Setup .....	51	<b>Troubleshooting</b> .....	<b>110</b>
TV Format Setup (not North American models)	52		
AM Frequency Step Setup (on some models)	53		
Automatic Speaker Setup			
(Audyssey MultEQ XT) .....	54		

# Front & Rear Panels

## Front Panel

### TX-SR705

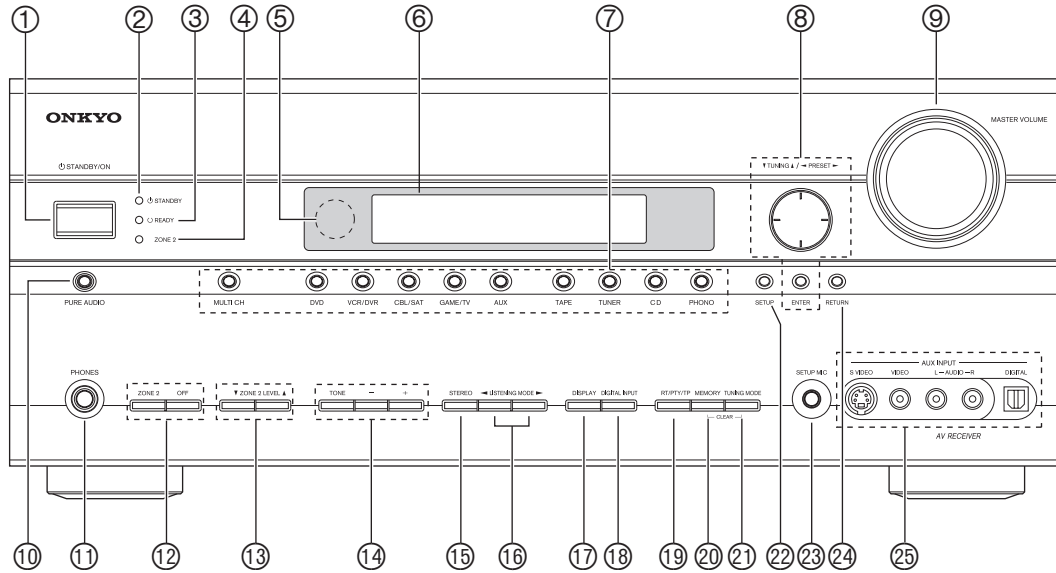

### TX-SA705

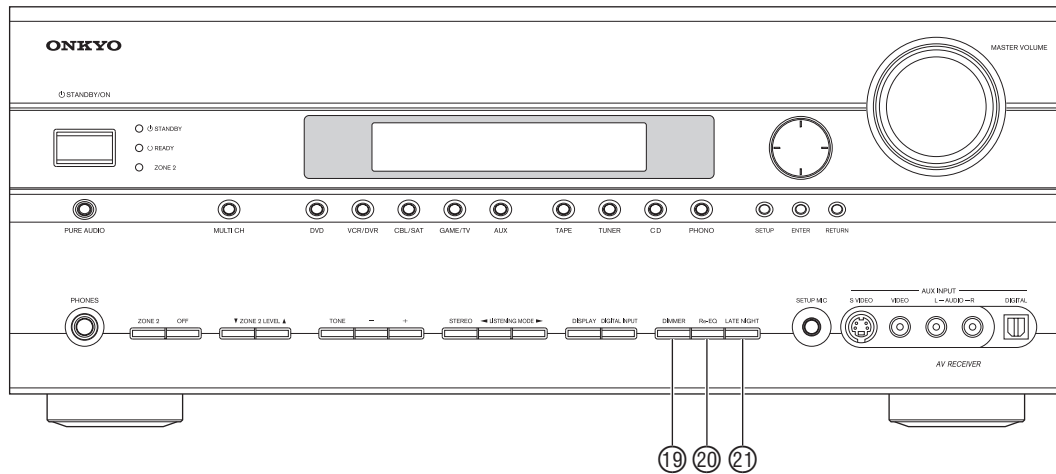

The page numbers in parentheses show where you can find the main explanation for each item.

- ① **STANDBY/ON button (44)**  
This button is used to set the AV receiver/AV amplifier to Standby or On.
- ② **STANDBY indicator (44)**  
This indicator lights up when the AV receiver/AV amplifier is in Standby mode, and it flashes while a signal is being received from the remote controller.
- ③ **READY indicator (96) (not North American models)**  
Enters Ready mode and lights up when the HDMI Power Control is set to Enable and the AV receiver/AV amplifier is on Standby.
- ④ **ZONE 2 indicator (101)**  
This indicator lights up when Zone 2 is selected.
- ⑤ **Remote control sensor (14)**  
This sensor receives control signals from the remote controller.
- ⑥ **Display**  
See “Display” on page 10.

## Front & Rear Panels—Continued

### ⑦ Input selector buttons (59)

These buttons are used to select from the following input sources: MULTI CH, DVD, VCR/DVR, CBL/SAT, GAME/TV, AUX, TAPE, TUNER, CD, PHONO.

The [MULTI CH] button selects the DVD analog multichannel input.

### ⑧ Arrow/TUNING/PRESET & ENTER buttons

When the AM or FM input source is selected, the TUNING [▲] [▼] buttons are used to tune the tuner, and the PRESET [◀] [▶] buttons are used to select radio presets (see page 63) (TX-SR705 only). When the onscreen setup menus are used, they work as arrow buttons and are used to select and set items. The [ENTER] button is also used with the onscreen setup menus.

### ⑨ MASTER VOLUME control (59) and indicator

This control is used to adjust the volume of the AV receiver/AV amplifier to  $-\infty$  dB,  $-81$  dB through  $+18$  dB (relative display).

### ⑩ PURE AUDIO button (66)

Selects the Pure Audio listening mode.

### ⑪ PHONES jack (61)

This 1/4-inch phone jack is for connecting a standard pair of stereo headphones for private listening.

### ⑫ ZONE 2/OFF buttons (101)

The ZONE 2 button is used to select the input source for Zone 2.

The OFF button is used to turn off the output of Zone 2.

### ⑬ ZONE 2 LEVEL button (102)

This button is used to set the volume for Zone 2.

### ⑭ TONE, [-] & [+] buttons (60)

These buttons are used to adjust the bass and treble.

### ⑮ STEREO button (66)

This button is used to select the Stereo listening mode.

### ⑯ LISTENING MODE [◀] [▶] buttons (66)

These buttons are used to select the listening modes.

### ⑰ DISPLAY button (60)

This button is used to display various information about the currently selected input source.

### ⑱ DIGITAL INPUT button (51, 97)

This button is used to assign the digital inputs and to specify the format of digital input signals.

### ⑲ RT/PTY/TP or DIMMER button (65, 61)

On the European model, this is the RT/PTY/TP button, and it's for RDS (Radio Data System). See "Using RDS (European models only)" on page 64.

On other models, this is the DIMMER button, and it's used to adjust the display brightness.

### ⑳ MEMORY or Re-EQ button (63)

This button is used when storing or deleting radio presets.

On the TX-SA705, this button is used to turn the Re-EQ function on or off.

### ㉑ TUNING MODE or LATE NIGHT button (62)

This button is used to select the Auto or Manual tuning mode.

On the TX-SA705, this button is used to turn the Late Night function on or off.

### ㉒ SETUP button

This button is used to access the onscreen setup menus that appear on the connected TV.

### ㉓ SETUP MIC jack (54)

The included speaker setup microphone is connected here for automatic speaker setup.

### ㉔ RETURN button

This button is used to return to the previously displayed onscreen setup menu.

### ㉕ AUX INPUT

This input can be used to connect a camcorder, game console, and so on. There are jacks for optical digital audio, S-Video, composite video, and analog audio.

## Front & Rear Panels—Continued

### Display

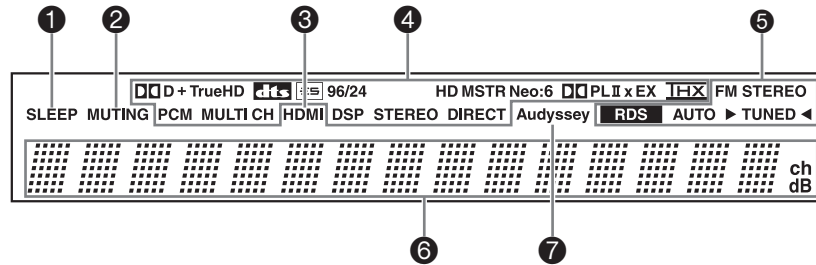

The page numbers in parentheses show where you can find the main explanation for each item.

**1 SLEEP indicator (61)**

This indicator lights up when the Sleep function has been set.

**2 MUTING indicator (61)**

This indicator flashes or lights up while the AV receiver/AV amplifier is muted.

**3 HDMI indicator**

This indicator lights up when the HDMI audio signal input is used.

**4 Listening mode & format indicators**

These indicators show the currently selected listening mode and the format of digital input signals.

**5 Tuning indicators (TX-SR705 only)**

**FM STEREO (62):** This indicator lights up when the AV receiver is tuned to a stereo FM station.

**RDS (European models only) (64):** This indicator lights up when tuned to a radio station that supports RDS (Radio Data System).

**AUTO (62):** This indicator lights up when the Auto Tuning mode is selected, and disappears when the Manual Tuning mode is selected.

**TUNED (62):** This indicator lights up when the AV receiver is tuned into a radio station.

**6 Message area**

This area of the display shows various information about the currently selected source.

**7 Audyssey indicator (54)**

This indicator flashes during automatic speaker setup and stays on when the setup is complete. It also lights up when the Equalizer Settings are set to Audyssey.

## Front & Rear Panels—Continued

### Rear Panel

#### TX-SR705 North American model

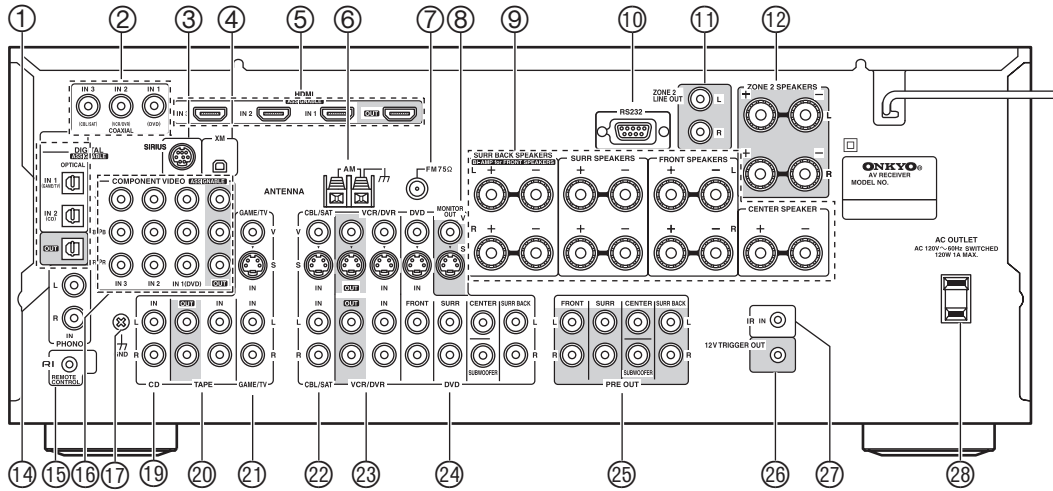

#### TX-SR705 other than North American model

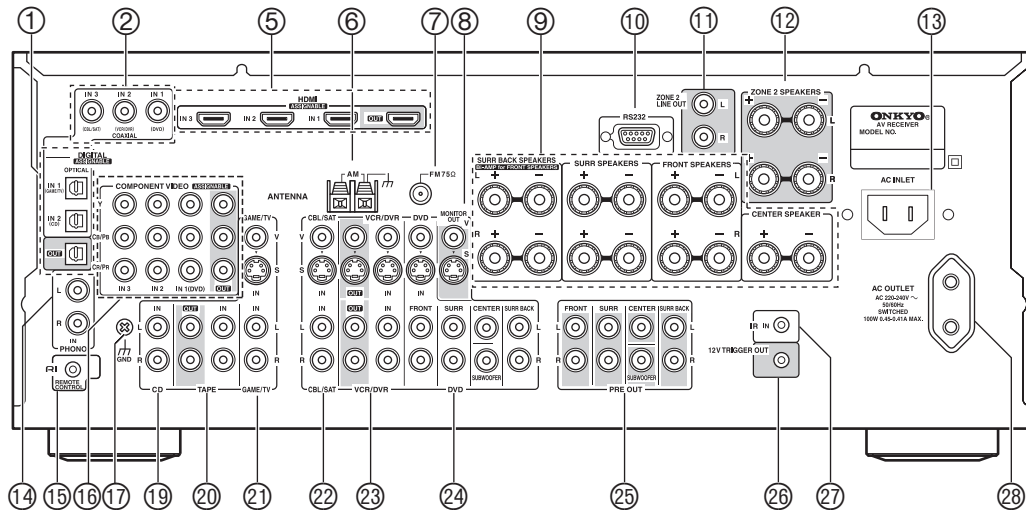

#### TX-SA705

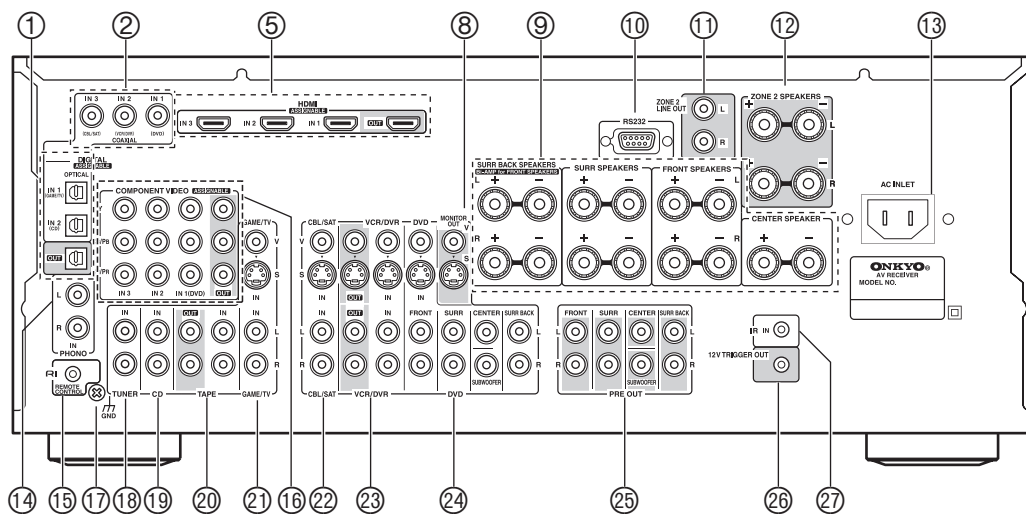

## Front & Rear Panels—Continued

The page numbers in parentheses show where you can find the main explanation for each item.

- ① **DIGITAL OPTICAL IN 1, 2 and OUT**  
These optical digital audio inputs are for connecting components with optical digital audio outputs, such as CD and DVD players.  
The optical digital audio output is for connecting a digital recorder with an optical digital input, such as a CD recorder.
- ② **DIGITAL COAXIAL IN 1, 2 and 3**  
These coaxial digital audio inputs are for connecting components with coaxial digital audio outputs, such as CD and DVD players.
- ③ **SIRIUS antenna (North American models only)**  
This jack is for connecting a SIRIUS Satellite Radio antenna (see the separate SIRIUS instructions).
- ④ **XM antenna (North American models only)**  
This jack is for connecting an XM Minituner and Home Dock, sold separately (see the separate XM instructions).
- ⑤ **HDMI IN 1, 2, 3, and OUT**  
HDMI (High Definition Multimedia Interface) connections carry digital audio and digital video.  
The HDMI inputs are for connecting components with HDMI outputs, such as DVD players.  
The HDMI output is for connecting a TV or projector with an HDMI input.
- ⑥ **AM ANTENNA (TX-SR705 only) (25)**  
These push terminals are for connecting an AM antenna.
- ⑦ **FM ANTENNA (TX-SR705 only) (25)**  
This jack is for connecting an FM antenna.
- ⑧ **MONITOR OUT**  
The S-Video or composite video jack should be connected to a video input on your TV or projector.
- ⑨ **FRONT, CENTER, SURR & SURR BACK SPEAKERS (23)**  
These terminal posts are for connecting your front, center, surround, and surround back speakers.
- ⑩ **RS232**  
This port is for connecting the AV receiver/AV amplifier to home automation equipment and external controllers.
- ⑪ **ZONE 2 LINE OUT (99)**  
This analog audio output can be connected to a line input on an integrated amplifier in Zone 2.
- ⑫ **ZONE 2 SPEAKERS (99)**  
These terminals are for connecting speakers in Zone 2.
- ⑬ **AC INLET (not North American models)**  
The supplied power cord is connected here. The other end of the power cord should be connected to a suitable wall outlet.
- ⑭ **PHONO IN**  
This audio input is for connecting a turntable.
- ⑮ **RI REMOTE CONTROL**  
This **RI** (Remote Interactive) jack can be connected to an **RI** jack on another Onkyo AV component. The AV receiver/AV amplifier's remote controller can then be used to control that component. To use **RI**, you must make an analog audio connection (RCA) between the AV receiver/AV amplifier and the other AV component, even if they are connected digitally.
- ⑯ **COMPONENT VIDEO IN 1, 2, 3, and OUT**  
These component video inputs can be used to connect AV components with component video outputs, such as DVD players.  
This component video output can be used to connect a TV or projector with a component video input.
- ⑰ **GND screw**  
This screw is for connecting a turntable's ground wire.
- ⑱ **TUNER IN (TX-SA705 only) (41)**  
This analog audio input is for connecting a tuner's analog audio output.
- ⑲ **CD IN**  
This analog audio input is for connecting a CD player's analog audio output.
- ⑳ **TAPE IN/OUT**  
This analog audio input and output are for connecting a recorder with an analog audio input and output (cassette, Mini Disc, etc.).
- ㉑ **GAME/TV IN**  
Here you can connect a game console, TV, etc. Input jacks include S-Video, composite video, and analog audio.
- ㉒ **CBL/SAT IN**  
Here you can connect a cable/satellite receiver, set-top box, etc. Input jacks include S-Video, composite video, and analog audio.
- ㉓ **VCR/DVR IN/OUT**  
Here you can connect a VCR or DVR (digital video recorder). Input and output jacks include S-Video, composite video, and analog audio.

## Front & Rear Panels—Continued

### ②④ DVD IN

Here you can connect a DVD player. Input jacks include S-Video, composite video, and analog audio. You can connect a DVD player's 2-channel analog audio output or 7.1-channel analog audio output.

### ②⑤ PRE OUT: FRONT L/R, CENTER, SUBWOOFER, SURR L/R, and SURR BACK L/R (22)

This 5.1/7.1 multichannel analog audio output can be connected to the analog audio input on a multichannel power amplifier for when you want to use the AV receiver solely as a preamplifier. The SUBWOOFER jack is for connecting a powered subwoofer.

### ②⑥ 12V TRIGGER OUT

This output can be connected to the 12-volt trigger input on a component in Zone 2. When Zone 2 is turned on on the AV receiver/AV amplifier, a 12-volt trigger signal is output.

### ②⑦ IR IN

A commercially available IR receiver can be connected to the IR IN jack, allowing you to control the AV receiver/AV amplifier while you're in Zone 2, or control it when it's out of sight, for example, installed in a cabinet.

### ②⑧ AC OUTLET (North American and European models only)

These switched AC outlets can be used to supply power to other AV components. The type and number of outlets depends on the country in which you purchased your AV receiver.

See pages 21-43 for connection information.

# Remote Controller

## Installing the Batteries

- 1** To open the battery compartment, press the small hollow and slide off the cover.

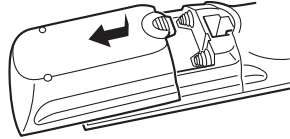

- 2** Insert the three supplied batteries (AA/R6) in accordance with the polarity diagram inside the battery compartment.

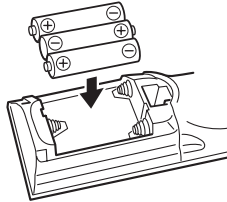

- 3** Put the cover onto the remote controller and slide it shut.

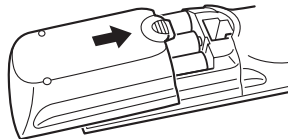

### Notes:

- If the remote controller doesn't work reliably, try replacing the batteries.
- Don't mix new and old batteries or different types of batteries.
- If you intend not to use the remote controller for a long time, remove the batteries to prevent damage from leakage or corrosion.
- Expired batteries should be removed as soon as possible to prevent damage from leakage or corrosion.

## Aiming the Remote Controller

To use the remote controller, point it at the AV receiver/AV amplifier's remote control sensor, as shown below.

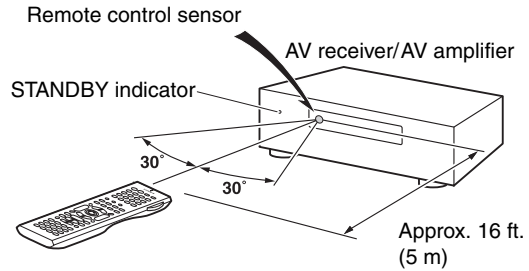

### Notes:

- The remote controller may not work reliably if the AV receiver/AV amplifier is subjected to bright light, such as direct sunlight or inverter-type fluorescent lights. Keep this in mind when installing.
- If another remote controller of the same type is used in the same room, or the AV receiver/AV amplifier is installed close to equipment that uses infrared rays, the remote controller may not work reliably.
- Don't put anything, such as a book, on the remote controller, because the buttons may be pressed inadvertently, thereby draining the batteries.
- The remote controller may not work reliably if the AV receiver/AV amplifier is installed in a rack behind colored glass doors. Keep this in mind when installing.
- The remote controller will not work if there's an obstacle between it and the AV receiver/AV amplifier's remote control sensor.

## Remote Controller—Continued

### Using the Remote Controller

As well as the AV receiver/AV amplifier, you can also use the remote controller to control your other AV components. The remote controller has a specific operating mode for use with each type of component. Modes are selected by using the REMOTE MODE buttons.

#### RECEIVER/TAPE Mode

In RECEIVER/TAPE mode, you can control the AV receiver/AV amplifier and an Onkyo cassette recorder connected via **RI**.

#### DVD Mode

By default, you can control an Onkyo DVD player in this mode. By entering the appropriate remote control code, you can control components made by other manufacturers (see page 104).

#### CD/CDR/MD Mode

By default, you can control an Onkyo CD player in this mode. By entering the appropriate remote control code, you can control a CD player, MD recorder, or CD recorder made by another manufacturer (see page 104).

#### DOCK Mode

This mode is for controlling an Apple iPod in an Onkyo RI Dock.

By default, you can control an RI Dock that has a remote control sensor such as DS-A2. When operating an RI Dock with an **RI** connection, you can control it by entering the appropriate remote control code (see page 104).

#### TV and VCR Modes

With these modes, you can control a TV and VCR. You must enter the appropriate remote control code first (see page 104).

#### CABLE/SAT Mode

In CABLE/SAT mode, you can control a cable or satellite TV receiver. You must enter the appropriate remote control code first (see page 104).

#### ZONE 2 Mode

This mode is for controlling Zone 2 (see page 101).

**1** Use the REMOTE MODE buttons to select a mode.

**2** Use the buttons supported by that mode to control the component.

RECEIVER/TAPE mode: see right column

DVD mode: see page 17

CD/MD/CDR mode: see page 18

DOCK mode: see page 19

TV, VCR, SAT/CABLE modes: see page 106

#### Note:

Some of the remote controller operations described in this manual may not work as expected with other components.

### RECEIVER/TAPE Mode

RECEIVER/TAPE mode is used to control the AV receiver/AV amplifier. It can also be used to control an Onkyo cassette recorder connected via **RI**.

To set the remote controller to RECEIVER/TAPE mode, press the [RECEIVER] REMOTE MODE button.

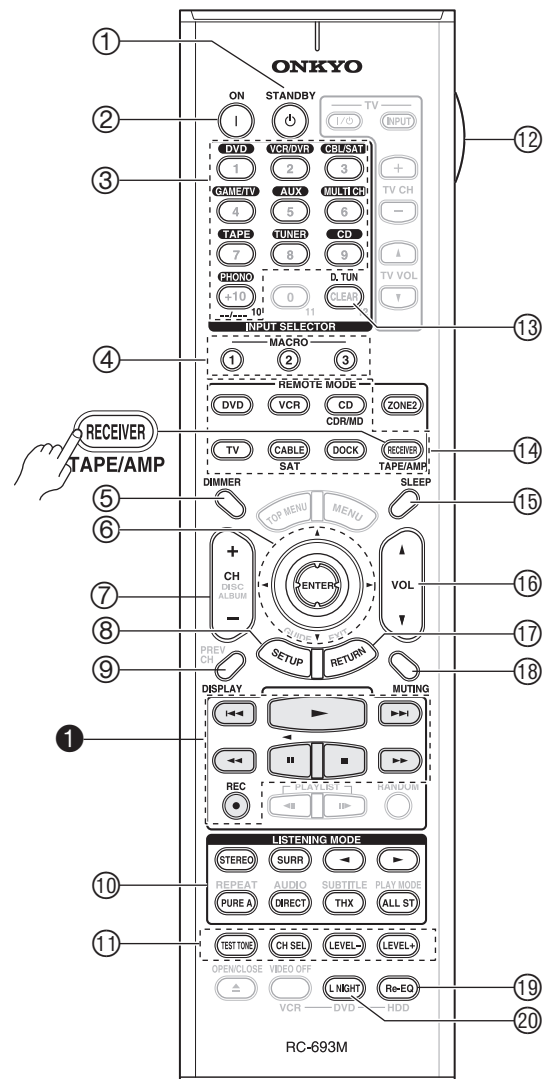

## Remote Controller—Continued

For detailed information, see the pages in parentheses.

- ① **STANDBY button (44)**  
Sets the AV receiver/AV amplifier to Standby.
- ② **ON button (44)**  
Turns on the AV receiver/AV amplifier.
- ③ **INPUT SELECTOR buttons (59)**  
Used to select the input sources.
- ④ **MACRO buttons (108)**  
Used with the Macro function.
- ⑤ **DIMMER button (61)**  
Adjusts the display brightness.
- ⑥ **Arrow [▲]/[▼]/[◀]/[▶] and ENTER buttons**  
Used to select and adjust settings.
- ⑦ **CH +/- button (63)**  
Used to select radio presets (TX-SR705).  
Used to select radio presets for a connected tuner (TX-SA705).
- ⑧ **SETUP button**  
Used to change settings.
- ⑨ **DISPLAY button (60)**  
Displays information about the current input source.
- ⑩ **LISTENING MODE buttons (66)**  
Used to select the listening modes. The [STEREO], [SURR], and LISTENING MODE [◀]/[▶] buttons can be used at any time, regardless of the currently selected remote controller mode.
- ⑪ **TEST TONE, CH SEL, LEVEL-, and LEVEL+ buttons (75, 81)**  
Used to adjust the level of each speaker.
- ⑫ **LIGHT button**  
Turns the remote controller's illuminated buttons on or off.
- ⑬ **D. TUN button (TX-SR705 only) (62)**  
Selects the Direct tuning mode for radio.
- ⑭ **REMOTE MODE buttons (15)**  
Used to select the remote controller modes. When you press a button, the REMOTE MODE button for the currently selected mode lights up.
- ⑮ **SLEEP button (61)**  
Used with the Sleep function.
- ⑯ **VOL [▲]/[▼] button (59)**  
Adjusts the volume of the AV receiver/AV amplifier regardless of the currently selected remote controller mode.
- ⑰ **RETURN button**  
Returns to the previous display when changing settings.
- ⑱ **MUTING button (61)**  
Mutes or unmutes the AV receiver/AV amplifier.
- ⑲ **Re-EQ button (75)**  
Turns the Re-EQ function on or off.

### ⑳ **L NIGHT button (75)**

Turns the Late Night function on or off.

### ■ **TAPE mode**

On twin cassette decks, only Deck B can be controlled.

### ① **Previous and Next [◀◀]/[▶▶] buttons**

The Previous [◀◀] button selects the previous track. During playback it selects the beginning of the current track. The Next [▶▶] button selects the next track.

Depending on how they were recorded, the Previous and Next [◀◀]/[▶▶] buttons may not work properly with some cassette tapes.

### **Play [▶] button**

Starts playback.

### **Rewind and Fast Forward [◀◀]/[▶▶] buttons**

The Rewind [◀◀] button starts rewind. The Fast Forward [▶▶] button starts fast forward.

### **Reverse Play [◀] button**

Starts reverse playback.

### **Stop [■] button**

Stops playback.

### **REC [●] button**

Starts recording.

## Remote Controller—Continued

### DVD Mode

To set the remote controller to DVD mode, press the [DVD] REMOTE MODE button.

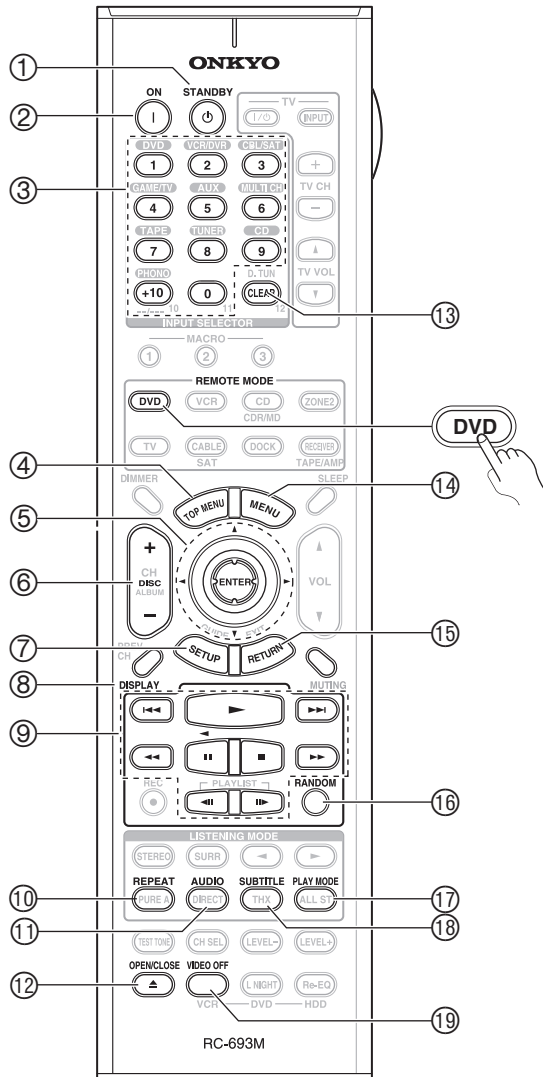

- ① **STANDBY button**  
Sets the DVD player to Standby.
- ② **ON button**  
Turns on the DVD player.
- ③ **Number buttons**  
Used to enter title, chapter, and track numbers and times for locating specific points.
- ④ **TOP MENU button**  
Selects a DVD's top menu.
- ⑤ **Arrow [▲]/[▼]/[◀]/[▶] and ENTER buttons**  
Used to navigate menus and select items.
- ⑥ **DISC +/- button**  
Selects discs on a DVD changer.
- ⑦ **SETUP button**  
Used to access the DVD player's settings.
- ⑧ **DISPLAY button**  
Displays information about the current disc, title, chapter, or track, including elapsed time, remaining time, total time, and so on.
- ⑨ **Playback buttons**  
From left to right: Previous, Play, Next, Rewind, Pause, Stop, Fast Forward, Slow Reverse, and Slow Forward.
- ⑩ **REPEAT button**  
Used with the repeat playback functions.
- ⑪ **AUDIO button**  
Selects foreign language soundtracks and audio formats (e.g., Dolby Digital or DTS).
- ⑫ **OPEN/CLOSE [▲] button**  
Opens and closes the disc tray.
- ⑬ **CLEAR button**  
Cancels functions and clears entered numbers.
- ⑭ **MENU button**  
Displays a DVD's menu.
- ⑮ **RETURN button**  
Exits the DVD player's onscreen setup menus.
- ⑯ **RANDOM button**  
Used with the random playback function.
- ⑰ **PLAY MODE button**  
Selects play modes on components with selectable play modes.
- ⑱ **SUBTITLE button**  
Selects subtitles.
- ⑲ **VIDEO OFF button**  
Turns off the internal video circuitry, eliminating any possibility of interference.

## Remote Controller—Continued

### CD/MD/CDR Modes

To control an Onkyo CD player, MD recorder, or CD recorder, or a CD or MD player/recorder made by another manufacturer, press the [CD] REMOTE MODE button to select the CD/MD/CDR remote controller mode.

In order to control an Onkyo MD recorder or CD recorder, or a component made by another manufacturer, you must first enter the appropriate remote control code (see page 104).

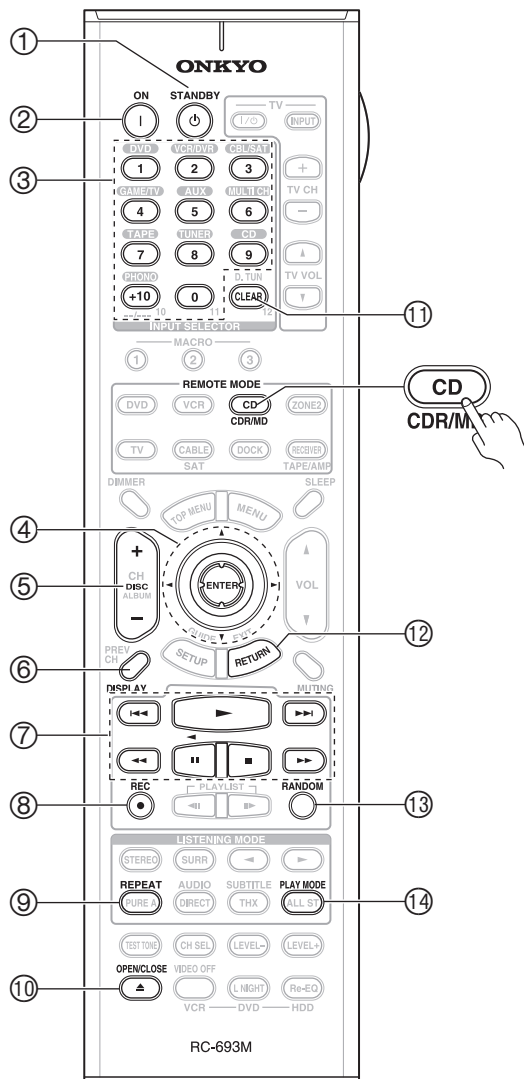

- ① **STANDBY button**  
Sets the component to Standby.
- ② **ON button**  
Set the component to On or Standby.
- ③ **Number buttons**  
Used to enter track numbers and times for locating specific points.
- ④ **Arrow [▲]/[▼]/[◀]/[▶] and ENTER buttons**  
Used with some components.
- ⑤ **DISC +/- button**  
Selects discs on a CD changer.
- ⑥ **DISPLAY button**  
Displays information about the current disc or track, including elapsed time, remaining time, total time, and so on.
- ⑦ **Playback buttons**  
From left to right: Previous, Play, Next, Rewind, Pause, Stop, and Fast Forward.
- ⑧ **REC [●] button**  
Starts recording.
- ⑨ **REPEAT button**  
Used with the repeat playback functions.
- ⑩ **OPEN/CLOSE [▲] button**  
Opens or closes the disc tray or ejects the MiniDisc.
- ⑪ **CLEAR button**  
Cancels functions and clears entered numbers.
- ⑫ **RETURN button**  
Used with some components.
- ⑬ **RANDOM button**  
Used with the random playback function.
- ⑭ **PLAY MODE button**  
Select play modes on components with selectable play modes.

## Remote Controller—Continued

### DOCK Mode

Dock mode is for controlling an Apple iPod in an Onkyo RI Dock.

#### When Using an RI Dock:

- Connect the RI Dock to the TAPE IN or GAME/TV IN L/R jacks.
- Set the RI Dock's RI MODE switch to HDD or HDD/DOCK.
- Set the AV receiver/AV amplifier's Input Display to DOCK (see page 50).
- When operating a DS-A1 RI Dock, enter the appropriate remote control code for the first time (see page 104).
- See to the RI Dock's instruction manual for more information.

To set the remote controller to DOCK mode, press the [DOCK] REMOTE MODE button.

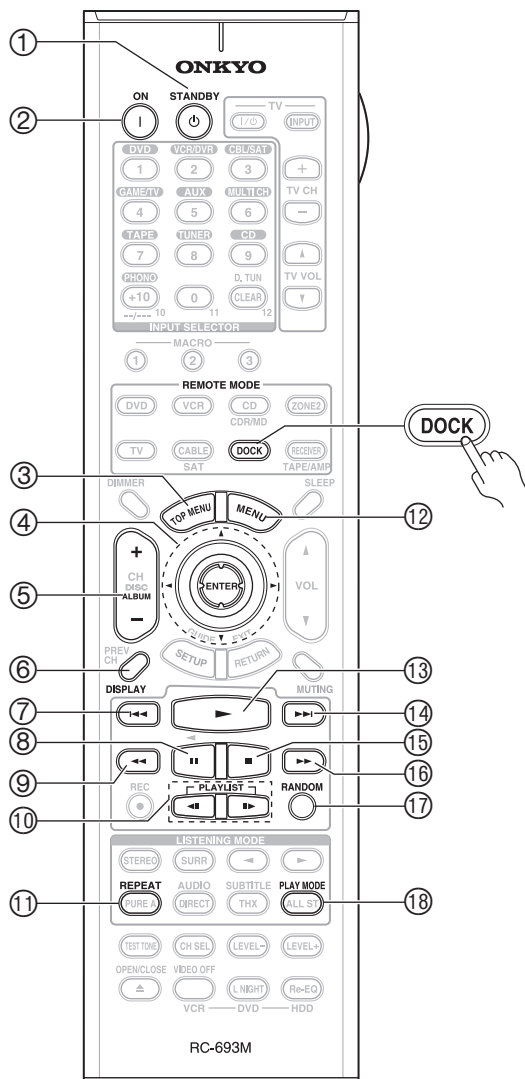

- STANDBY button**  
Turns off the iPod.
- ON button\***  
Turns on the iPod.
- TOP MENU button**  
Works as a Mode button when used with a DS-A2 RI Dock.
- Arrow [▲]/[▼] and ENTER buttons\***  
Used to navigate menus and select items.
- ALBUM +/- button\***  
Selects the next or previous album.
- DISPLAY button\***  
Turns on the backlight for 30 seconds.
- Previous [◀◀] button**  
Restarts the current song. Press it twice to select the previous song.
- Pause [||] button**  
Pauses playback. (With 3rd generation iPods, it works as a Play/Pause button.)
- Rewind [◀◀] button**  
Press and hold to rewind.
- Playlist [◀◀]/[▶▶] buttons\***  
Used to select the previous or next playlist on the iPod.
- REPEAT button\***  
Used with the repeat function.
- MENU button\***  
Used to access menus.
- Play [▶] button**  
Starts playback. If the component is off, it will turn on automatically. (With 3rd generation iPods, this button works as a Play/Pause button.)
- Next [▶▶] button**  
Selects the next song.
- Stop [■] button**  
Stops playback and displays a menu.
- Fast Forward [▶▶] button**  
Press and hold to fast forward.
- RANDOM button\***  
Used with the shuffle function.
- PLAY MODE button**  
Used to select play modes on components with selectable play modes.  
Works as a Resume button when used with a DS-A2 RI Dock.

\* Buttons marked with an asterisk (\*) are not supported by 3rd generation iPods.

# About Home Theater

## Enjoying Home Theater

Thanks to the AV receiver/AV amplifier's superb capabilities, you can enjoy surround sound with a real sense of movement in your own home—just like being in a movie theater or concert hall. With DVDs you can enjoy DTS and Dolby Digital. With analog and digital TV you can enjoy Dolby Pro Logic IIx or Onkyo's own DSP surround listening modes. You can also enjoy THX Surround EX (THX-certified THX speaker system recommended).

### Front left and right speakers

These output the overall sound. Their role in a home theater is to provide a solid anchor for the sound image. They should be positioned facing the listener at about ear level, and equidistant from the TV. Angle them inward so as to create a triangle, with the listener at the apex.

### Center speaker

This speaker enhances the front left and right speakers, making sound movements distinct and providing a full sound image. In movies it's used mainly for dialog.

Position it close to your TV facing forward at about ear level, or at the same height as the front left and right speakers.

### Subwoofer

The subwoofer handles the bass sounds of the LFE (Low-Frequency Effects) channel. The volume and quality of the bass output from your subwoofer will depend on its position, the shape of your listening room, and your listening position. In general, a good bass sound can be obtained by installing the subwoofer in a front corner, or at one-third the width of the wall, as shown.

**Tip:** To find the best position for your subwoofer, while playing a movie or some music with good bass, experiment by placing your subwoofer at various positions within the room, and choose the one that provides the most satisfying results.

### Surround back left and right speakers

These speakers are necessary to enjoy Dolby Digital EX, DTS-ES Matrix, DTS-ES Discrete, THX Surround EX, etc. They enhance the realism of surround sound and improve sound localization behind the listener. Position them behind the listener about 2–3 feet (60–100 cm) above ear level.

THX recommends that they be placed as close as possible in order to make advantage of their proprietary ASA (Advanced Speaker Array) technology. If this condition is not possible, adjust the Surr Back Sp Spacing setting via the THX Audio Setup. (See page 83.)

### Surround left and right speakers

These speakers are used for precise sound positioning and to add realistic ambience.

Position them at the sides of the listener, or slightly behind, about 2–3 feet (60–100 cm) above ear level. Ideally they should be equidistant from the listener.

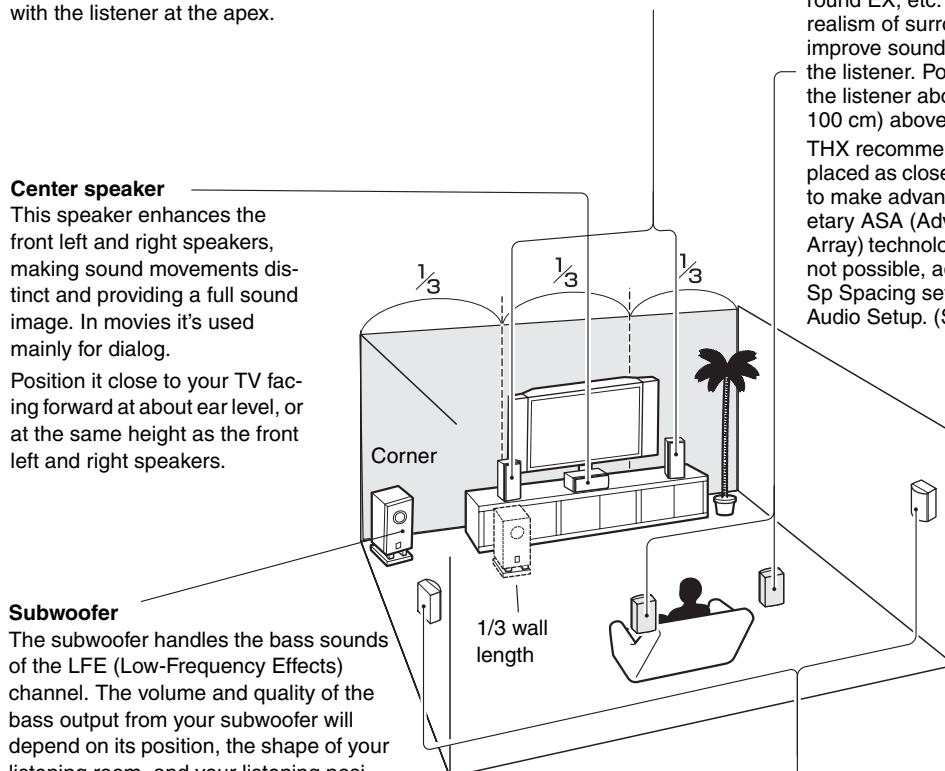

# Connecting the AV Receiver/AV Amplifier

## About AV Connections

- Before making any AV connections, read the manuals supplied with your other AV components.
- Don't connect the power cord until you've completed and double-checked all AV connections.

## Optical Digital Jacks

The AV receiver/AV amplifier's optical digital jacks have shutter-type covers that open when an optical plug is inserted and close when it's removed. Push plugs in all the way.

**Caution:** To prevent shutter damage, hold the optical plug straight when inserting and removing.

## AV Connection Color Coding

RCA-type AV connections are usually color-coded: red, white, and yellow. Use red plugs to connect right-channel audio inputs and outputs (typically labeled "R"). Use white plugs to connect left-channel audio inputs and outputs (typically labeled "L"). And use yellow plugs to connect composite video inputs and outputs.

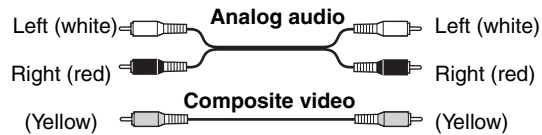

- Push plugs in all the way to make good connections (loose connections can cause noise or malfunctions).
- To prevent interference, keep audio and video cables away from power cords and speaker cables.

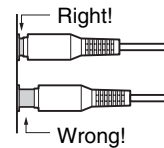

## AV Cables & Jacks

### Video

Cable	Jack	Description
		HDMI connections can carry uncompressed standard- or high-definition digital video and audio and offer the best picture and sound quality.
		Component video separates the luminance (Y) and color difference signals (PR, PB), providing the best picture quality (some TV manufacturers label their component video sockets slightly differently).
		S-Video separates the luminance and color signals and provides better picture quality than composite video.
		Composite video is commonly used on TVs, VCRs, and other video equipment. Use only dedicated composite video cables.

### Audio

Cable	Jack	Description
		Offers the best sound quality and allows you to enjoy surround sound (e.g., Dolby Digital, DTS). The audio quality is the same as for coaxial.
		Offers the best sound quality and allows you to enjoy surround sound (e.g., Dolby Digital, DTS). The audio quality is the same as for optical.
		This cable carries analog audio. It's the most common connection format for analog audio, and can be found on virtually all AV components.
		This cable carries multichannel analog audio and it's typically used to connect DVD players with a 7.1-channel analog audio output. Several standard analog audio cables can be used instead of a multichannel cable.

**Note:** The AV receiver/AV amplifier does not support SCART plugs.

## Connecting the AV Receiver/AV Amplifier—Continued

### Connecting Your Speakers

#### Speaker Configuration

For the best surround sound experience, you should connect seven speakers and a powered subwoofer.

The following table indicates the channels you should use depending on the number of speakers that you have.

Number of speakers:	2	3	4	5	6	7
Front left	✓	✓	✓	✓	✓	✓
Front right	✓	✓	✓	✓	✓	✓
Center		✓		✓	✓	✓
Surround left			✓	✓	✓	✓
Surround right			✓	✓	✓	✓
Surround back*					✓	
Surround back left						✓
Surround back right						✓

\*If you're using only one surround back speaker, connect it to the left (L) SURR BACK SPEAKERS terminals.

No matter how many speakers you use, a powered subwoofer is recommended for a really powerful and solid bass.

To get the best from your surround sound system, you need to set the speaker settings by using the supplied speaker setup microphone (see page 54).

#### Using Dipole Speakers

You can use dipole speakers for the surround left and right and surround back left and right speakers. Dipole speakers output the same sound in two directions.

Dipole speakers typically have an arrow printed on them to indicate how they should be positioned. The surround left and right dipole speakers should be positioned so that their arrows point toward the TV/screen, while the surround back left and right dipole speakers should be positioned so that their arrows point toward each other, as shown.

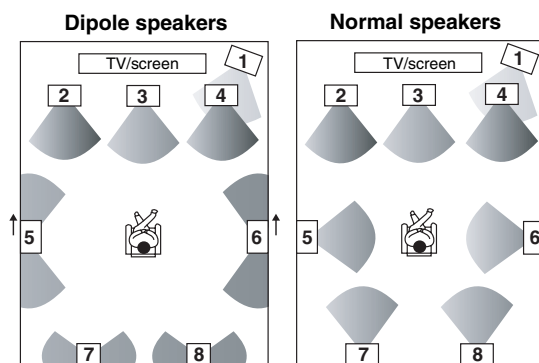

1. Subwoofer
2. Front left speaker
3. Center speaker
4. Front right speaker
5. Surround left speaker

6. Surround right speaker
7. Surround back left speaker
8. Surround back right speaker

### Connecting a Powered Subwoofer

Using a suitable cable, connect the AV receiver/AV amplifier's PRE OUT SUBWOOFER to an input on your powered subwoofer, as shown. If your subwoofer is unpowered and you're using an external amplifier, connect the PRE OUT SUBWOOFER to an input on the amp.

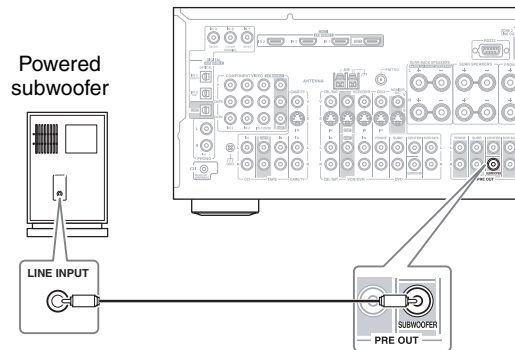

### Attaching the Speaker Labels

The AV receiver/AV amplifier's positive (+) speaker terminals are color-coded for ease of identification (the negative (-) speaker terminals are all black).

Speaker terminal	Color
Front left, Zone 2 left	White
Front right, Zone 2 right	Red
Center	Green
Surround left	Blue
Surround right	Gray
Surround back left	Brown
Surround back right	Tan

The supplied speaker cable labels are also color-coded and you should attach them to the positive (+) side of each speaker cable in accordance with the above table. Then all you need to do is to match the color of each label to the corresponding speaker terminal.



### Using the Speaker Terminal Tool

The supplied speaker terminal tool makes it easy to tighten and loosen the speaker terminals. If you are using banana plugs, to ensure optimum sound quality, tighten the speaker terminal before inserting the banana plug. (In Europe, using banana plugs to connect speakers to an audio amplifier is prohibited.)

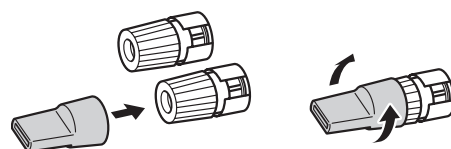

## Connecting the AV Receiver/AV Amplifier—Continued



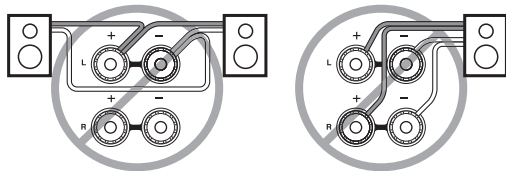
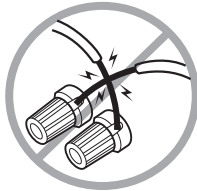

### Speaker Connection Precautions

Read the following before connecting your speakers:

- **North American models:** Only connect speakers with an impedance of 6 ohms or higher. If you use speakers with a lower impedance, and use the amplifier at high volume levels for a long period of time, the built-in protection circuit may be activated.
- **Other models:** You can connect speakers with an impedance of between 4 and 16 ohms. If the impedance of any of the connected speakers is 4 ohms or more, but less than 6 ohms, be sure to set the minimum speaker impedance to “4 ohms” (see page 46). If you use speakers with a lower impedance, and use the amplifier at high volume levels for a long period of time, the built-in protection circuit may be activated.
- Disconnect the power cord from the wall outlet before making any connections.
- Read the instructions supplied with your speakers.
- Pay close attention to speaker wiring polarity. In other words, connect positive (+) terminals only to positive (+) terminals, and negative (–) terminals only to negative (–) terminals. If you get them the wrong way around, the sound will be out of phase and will sound unnatural.
- Unnecessarily long, or very thin speaker cables may affect the sound quality and should be avoided.
- If you use 4 or 5 speakers, connect each of the two surround speakers to the SURR SPEAKERS terminals. Do not connect them to the SURR BACK SPEAKERS terminals.
- Be careful not to short the positive and negative wires. Doing so may damage the AV receiver/AV amplifier.
- Make sure the metal core of the wire does not have contact with the AV receiver/AV amplifier’s rear panel. Doing so may damage the AV receiver/AV amplifier.
- Don’t connect more than one cable to each speaker terminal. Doing so may damage the AV receiver/AV amplifier.
- Don’t connect one speaker to several terminals.

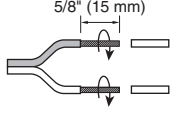

### Connecting the Speaker Cables

- 1 Strip about 5/8" (15 mm) of insulation from the ends of the speaker cables, and twist the bare wires tightly, as shown. 
- 2 Unscrew the terminal. 
- 3 Fully insert the bare wires. 
- 4 Screw the terminal tight. 

The following illustration shows which speaker should be connected to each pair of terminals. If you’re using only one surround back speaker, connect it to the left (L) SURR BACK SPEAKERS terminals.

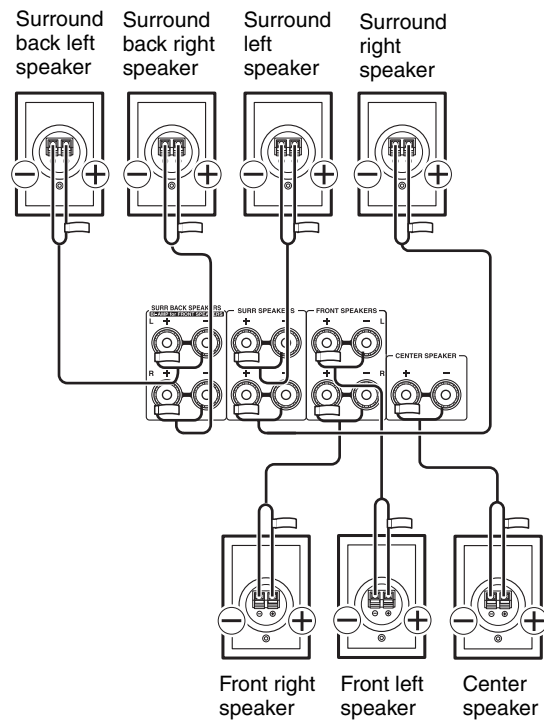

## Connecting the AV Receiver/AV Amplifier—Continued

### Bi-amping the Front Speakers

The FRONT SPEAKERS L/R and SURR BACK SPEAKERS L/R terminal posts can be used with front speakers and surround back speakers respectively, or bi-amped to provide separate tweeter and woofer feeds for a pair of front speakers that support bi-amping, providing improved bass and treble performance.

- When bi-amping is used, the AV receiver/AV amplifier is able to drive up to 5.1 speakers in the main room.
- For bi-amping, the FRONT SPEAKERS L/R terminal posts connect to the front speakers' tweeter terminals. And the SURR BACK SPEAKERS L/R terminal posts connect to the front speakers' woofer terminals.
- Once you've completed the bi-amping connections shown below and turned on the AV receiver/AV amplifier, you must set the Speakers Type setting to Bi-Amp to enable biamping (see page 46).

#### Important:

- **When making the bi-amping connections, be sure to remove the jumper bars that link the speakers' tweeter (high) and woofer (low) terminals.**

### Bi-amping Speaker Hookup

- 1 Connect the AV receiver/AV amplifier's FRONT SPEAKERS R positive (+) terminal to the right speaker's positive (+) tweeter (high) terminal. And connect the AV receiver/AV amplifier's FRONT SPEAKERS R negative (–) terminal to the right speaker's negative (–) tweeter (high) terminal.
- 2 Connect the AV receiver/AV amplifier's SURR BACK SPEAKERS R positive (+) terminal to the right speaker's positive (+) woofer (low) terminal. And connect the AV receiver/AV amplifier's SURR BACK SPEAKERS R negative (–) terminal to the right speaker's negative (–) woofer (low) terminal.
- 3 Connect the AV receiver/AV amplifier's FRONT SPEAKERS L positive (+) terminal to the left speaker's positive (+) tweeter (high) terminal. And connect the AV receiver/AV amplifier's FRONT SPEAKERS L negative (–) terminal to the left speaker's negative (–) tweeter (high) terminal.
- 4 Connect the AV receiver/AV amplifier's SURR BACK SPEAKERS L positive (+) terminal to the left speaker's positive (+) woofer (low) terminal. And connect the AV receiver/AV amplifier's SURR BACK SPEAKERS L negative (–) terminal to the left speaker's negative (–) woofer (low) terminal.

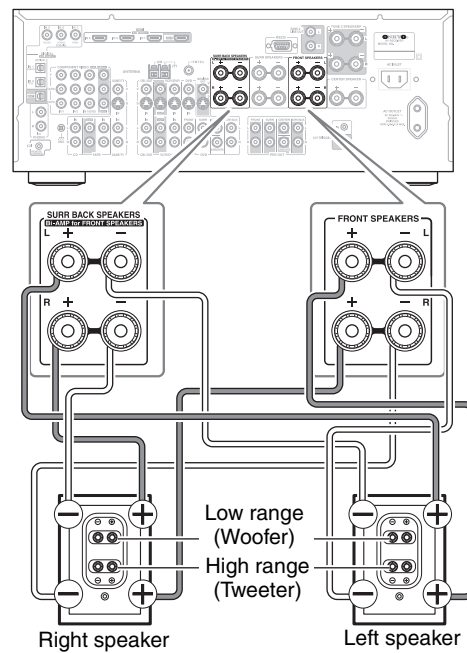

## Connecting the AV Receiver/AV Amplifier—Continued

### Connecting Antenna (TX-SR705 only)

This section explains how to connect the supplied indoor FM antenna and AM loop antenna, and how to connect commercially available outdoor FM and AM antennas. The AV receiver won't pick up any radio signals without any antenna connected, so you must connect the antenna to use the tuner.

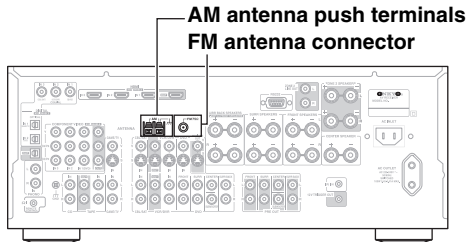

### Connecting the Indoor FM Antenna

The supplied indoor FM antenna is for indoor use only.

#### 1 Attach the FM antenna, as shown.

##### ■ North American models

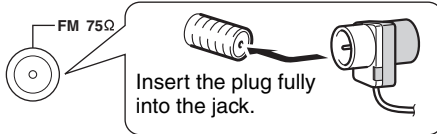

##### ■ Other models

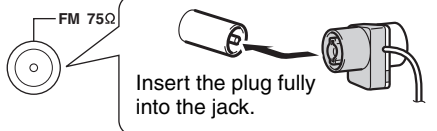

Once your AV receiver is ready for use, you'll need to tune into an FM radio station and adjust the position of the FM antenna to achieve the best possible reception.

#### 2 Use thumbtacks or something similar to fix the FM antenna into position.

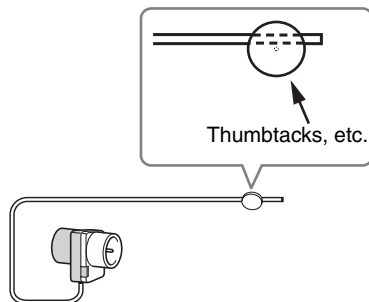

**Caution:** Be careful that you don't injure yourself when using thumbtacks.

If you cannot achieve good reception with the supplied indoor FM antenna, try a commercially available outdoor FM antenna instead (see page 26).

### Connecting the AM Loop Antenna

The supplied indoor AM loop antenna is for indoor use only.

#### 1 Assemble the AM loop antenna, inserting the tabs into the base, as shown.

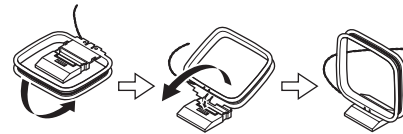

#### 2 Connect both wires of the AM loop antenna to the AM antenna push terminals, as shown.

(The antenna's wires are not polarity sensitive, so they can be connected either way around.)

Make sure that the wires are attached securely and that the push terminals are gripping the bare wires, not the insulation.

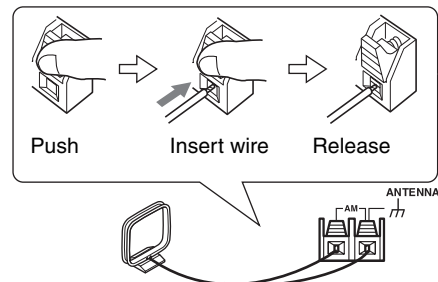

Once your AV receiver is ready for use, you'll need to tune into an AM radio station and adjust the position of the AM antenna to achieve the best possible reception.

Keep the antenna as far away as possible from your AV receiver, TV, speaker cables, and power cords.

If you cannot achieve good reception with the supplied indoor AM loop antenna, try using it with a commercially available outdoor AM antenna (see page 26).

## Connecting the AV Receiver/AV Amplifier—Continued

### Connecting an Outdoor FM Antenna

If you cannot achieve good reception with the supplied indoor FM antenna, try a commercially available outdoor FM antenna instead.

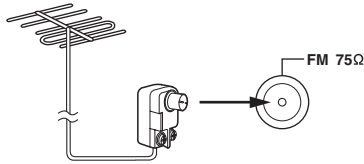

#### Notes:

- Outdoor FM antennas work best outside, but usable results can sometimes be obtained when installed in an attic or loft.
- For best results, install the outdoor FM antenna well away from tall buildings, preferably with a clear line of sight to your local FM transmitter.
- Outdoor antenna should be located away from possible noise sources, such as neon signs, busy roads, etc.
- For safety reasons, outdoor antenna should be situated well away from power lines and other high-voltage equipment.
- Outdoor antenna must be grounded in accordance with local regulations to prevent electrical shock hazards.

### Using a TV/FM Antenna Splitter

It's best not to use the same antenna for both FM and TV reception, as this can cause interference problems. If circumstances demand it, use a TV/FM antenna splitter, as shown.

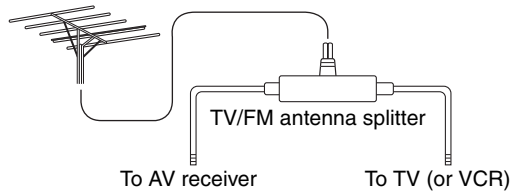

### Connecting an Outdoor AM Antenna

If good reception cannot be achieved using the supplied AM loop antenna, an outdoor AM antenna can be used in addition to the loop antenna, as shown.

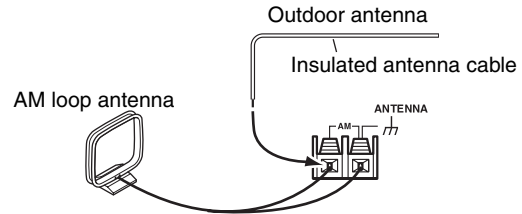

Outdoor AM antennas work best when installed outside horizontally, but good results can sometimes be obtained indoors by mounting horizontally above a window. Note that the AM loop antenna should be left connected.

Outdoor antenna must be grounded in accordance with local regulations to prevent electrical shock hazards.

## Connecting the AV Receiver/AV Amplifier—Continued

### Connecting Both Audio & Video

By connecting both the audio and video outputs of your DVD player and other AV components to the AV receiver/AV amplifier, you can select both the audio and video simultaneously simply by selecting the appropriate input source on the AV receiver/AV amplifier.

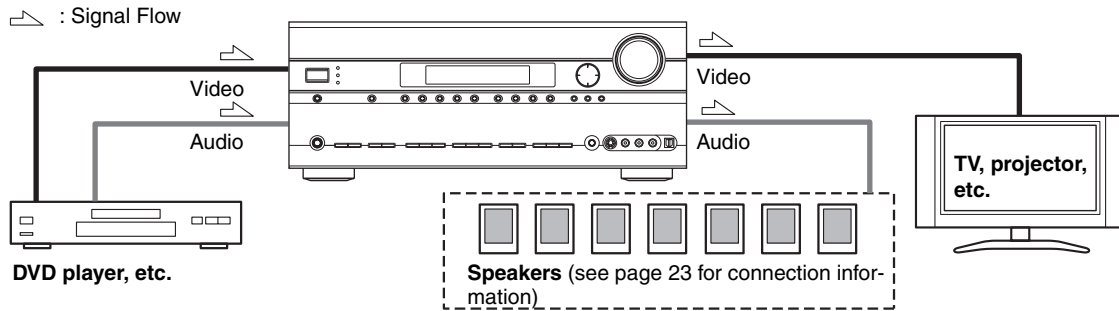

### Which Connections Should I Use?

The AV receiver/AV amplifier supports several connection formats for compatibility with a wide range of AV equipment. The format you choose will depend on the formats supported by your other components. Use the following sections as a guide.

For video components, you must make two connections—one for audio, one for video.

#### Video Connection Formats

Video equipment can be connected to the AV receiver/AV amplifier by using any one of the following video connection formats:

composite video, S-Video, component video, or HDMI, the latter offering the best picture quality.

The AV receiver/AV amplifier can upconvert and downconvert between video formats, depending on the HDMI Monitor setting, which generally determines whether video signals are upconverted for the component video output or the HDMI output.

**For optimal video performance, THX recommends that video signals pass through the system without upconversion (e.g., component video input through to component video output). It's also recommended that you set the Immediate Display preference to Off (page 93).**

#### ■ HDMI Monitor Setting Set to Yes

With the HDMI Monitor setting set to Yes (see page 47), video input signals flow through the AV receiver/AV amplifier as shown, with composite video, S-Video, and component video sources all being upconverted for the HDMI output. Use this setting if you connect the AV receiver/AV amplifier's HDMI OUT to your TV. The composite video, S-Video, and component video outputs pass through their respective input signals as they are.

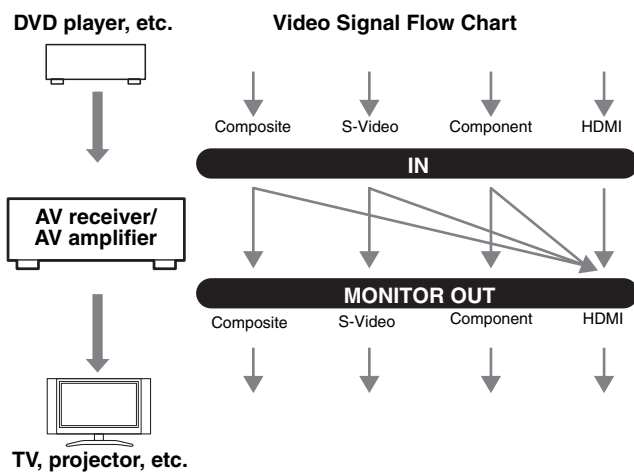

## Connecting the AV Receiver/AV Amplifier—Continued

### ■ HDMI Monitor Setting Set to No

With the HDMI Monitor setting set to No (see page 47), video input signals flow through the AV receiver/AV amplifier as shown, with composite video and S-Video sources being upconverted for the component video output. Use this setting if you connect the AV receiver/AV amplifier's COMPONENT VIDEO OUT to your TV. Composite video is upconverted to S-Video and S-Video is downconverted to composite video. Note that these conversions only apply to the MONITOR OUT V and S outputs, not the VCR/DVR OUT V and S outputs. The composite video, S-Video, and component video outputs pass through their respective input signals as they are.

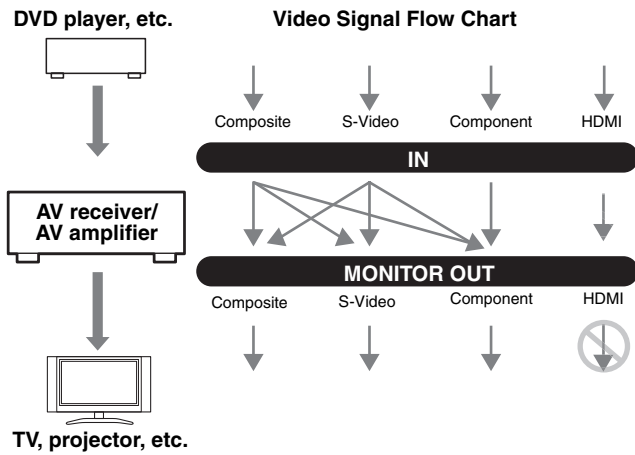

### Audio Connection Formats

Audio equipment can be connected to the AV receiver/AV amplifier by using any of the following audio connection formats: analog, optical, coaxial, analog multichannel, or HDMI. When choosing a connection format, bear in mind that the AV receiver/AV amplifier does not convert digital input signals for analog line outputs and vice versa. For example, audio signals connected to an optical or coaxial digital input are not output by the analog TAPE OUT.

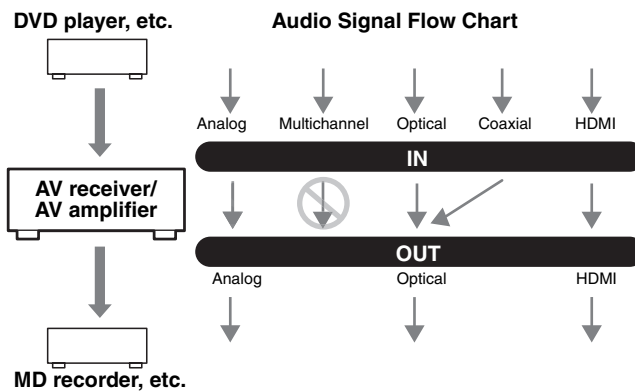

## Connecting the AV Receiver/AV Amplifier—Continued

### Connecting a TV or Projector

#### Step 1: Video Connection

Choose a video connection that matches your TV (**A**, **B**, or **C**), and then make the connection.

#### Step 2: Audio Connection

Choose an audio connection that matches your TV (**a**, **b**, or **c**), and then make the connection.

- With connection **a**, you can listen to and record audio from your TV and listen in Zone 2.
- To enjoy Dolby Digital and DTS, use connection **b** or **c**. (For recording, use **a** and **b**, or **a** and **c**.)

Connection	AV receiver/AV amplifier	Signal flow	TV	Picture quality
<b>A</b>	COMPONENT VIDEO OUT	⇒	Component video input	Best
<b>B</b>	MONITOR OUT S	⇒	S-Video input	Better
<b>C</b>	MONITOR OUT V	⇒	Composite video input	Standard
<b>a</b>	GAME/TV IN L/R	⇐	Analog audio L/R output	
<b>b</b>	DIGITAL COAXIAL IN 3 (CBL/SAT)	⇐	Digital coaxial output	
<b>c</b>	DIGITAL OPTICAL IN 1 (GAME/TV)	⇐	Digital optical output	

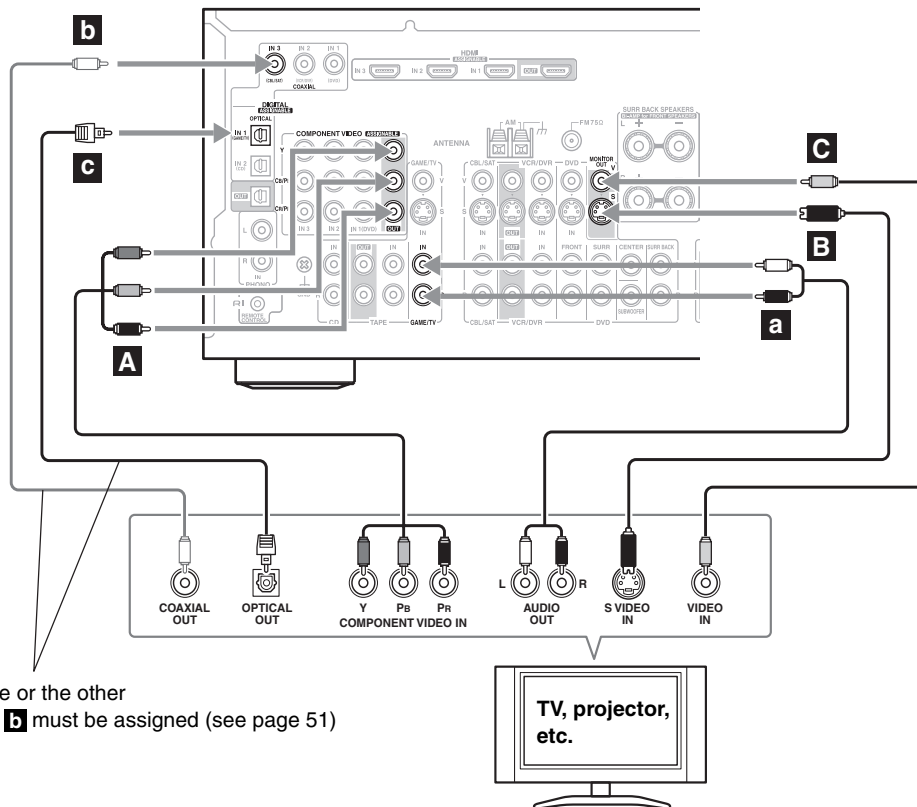

Connect one or the other  
Connection **b** must be assigned (see page 51)



If your TV has no audio outputs, connect an audio output from your VCR or cable or satellite receiver to the AV receiver/AV amplifier and use its tuner to listen to TV programs through the AV receiver/AV amplifier (see pages 32 and 34).

## Connecting the AV Receiver/AV Amplifier—Continued

### Connecting a DVD Player

#### Step 1: Video Connection

Choose a video connection that matches your DVD player (**A**, **B**, or **C**), and then make the connection. You must connect the AV receiver/AV amplifier to your TV via the same type of connection.

#### Step 2: Audio Connection

Choose an audio connection that matches your DVD player (**a**, **b**, or **c**), and then make the connection.

- With connection **a**, you can listen to and record audio from a DVD and listen in Zone 2.
- To enjoy Dolby Digital and DTS, use connection **b** or **c**. (For recording, use **a** and **b**, or **a** and **c**.)
- If your DVD player has main left and right outputs and multichannel left and right outputs, be sure to use the main left and right outputs for connection **a**.

Connection	AV receiver/AV amplifier	Signal flow	DVD player	Picture quality
<b>A</b>	COMPONENT VIDEO IN 1 (DVD)	←	Component video output	Best
<b>B</b>	DVD IN S	←	S-Video output	Better
<b>C</b>	DVD IN V	←	Composite video output	Standard
<b>a</b>	DVD IN FRONT L/R	←	Analog audio L/R output	
<b>b</b>	DIGITAL COAXIAL IN 1 (DVD)	←	Digital coaxial output	
<b>c</b>	DIGITAL OPTICAL IN 1 (GAME/TV)	←	Digital optical output	

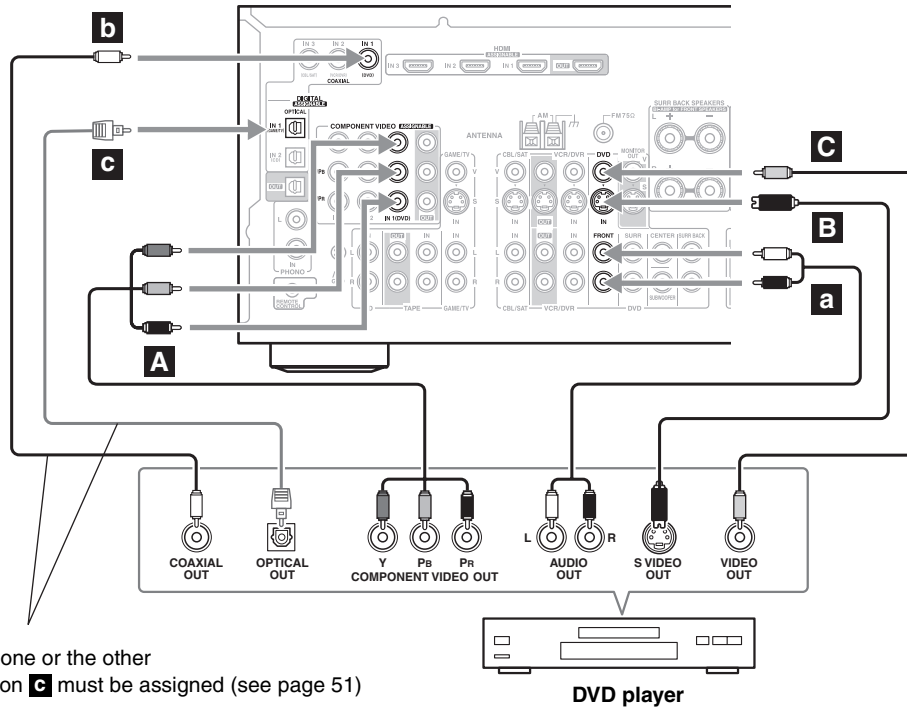

Connect one or the other  
Connection **C** must be assigned (see page 51)

To connect a DVD player or DVD-Audio/SACD-capable player with a multichannel analog audio output, see page 31. ➔

## Connecting the AV Receiver/AV Amplifier—Continued

### Hooking Up the Multichannel DVD Input

If your DVD player supports multichannel audio formats such as DVD-Audio or SACD, and it has a multichannel analog audio output, you can connect it to the AV receiver/AV amplifier's multichannel DVD input.

Use a multichannel analog audio cable, or several normal audio cables, to connect the AV receiver/AV amplifier's DVD FRONT L/R, CENTER, SURR L/R, SURR BACK L/R, and SUBWOOFER jacks to the 7.1-channel analog audio output on your DVD player. If your DVD player has a 5.1-channel analog audio output, don't connect anything to the AV receiver/AV amplifier's SURR BACK L/R jacks.

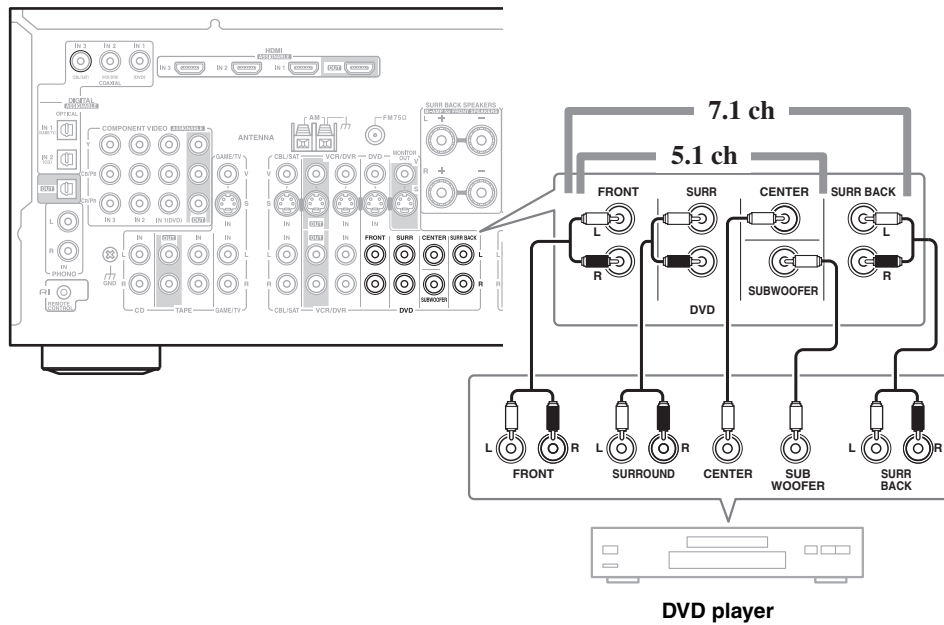

## Connecting the AV Receiver/AV Amplifier—Continued

### Connecting a VCR or DVD Recorder for Playback



**Hint!** With this hookup, you can use your VCR's tuner to listen to your favorite TV programs via the AV receiver/AV amplifier, useful if your TV has no audio outputs.

**Step 1: Video Connection**  
 Choose a video connection that matches your VCR or DVD recorder (**A**, **B**, or **C**), and then make the connection. You must connect the AV receiver/AV amplifier to your TV via the same type of connection.

**Step 2: Audio Connection**  
 Choose an audio connection that matches your VCR or DVD recorder (**a**, **b**, or **c**), and then make the connection.

- With connection **a**, you can listen to the VCR or DVD recorder even in Zone 2.
- To enjoy Dolby Digital and DTS, use connection **b** or **c**. (To listen in Zone 2 as well, use **a** and **b**, or **a** and **c**.)

Connection	AV receiver/AV amplifier	Signal flow	VCR or DVD recorder	Picture quality
<b>A</b>	COMPONENT VIDEO IN 2	←	Component video output	Best
<b>B</b>	VCR/DVR IN S	←	S-Video output	Better
<b>C</b>	VCR/DVR IN V	←	Composite video output	Standard
<b>a</b>	VCR/DVR IN L/R	←	Analog audio L/R output	
<b>b</b>	DIGITAL COAXIAL IN 2 (VCR/DVR)	←	Digital coaxial output	
<b>c</b>	DIGITAL OPTICAL IN 1 (GAME/TV)	←	Digital optical output	

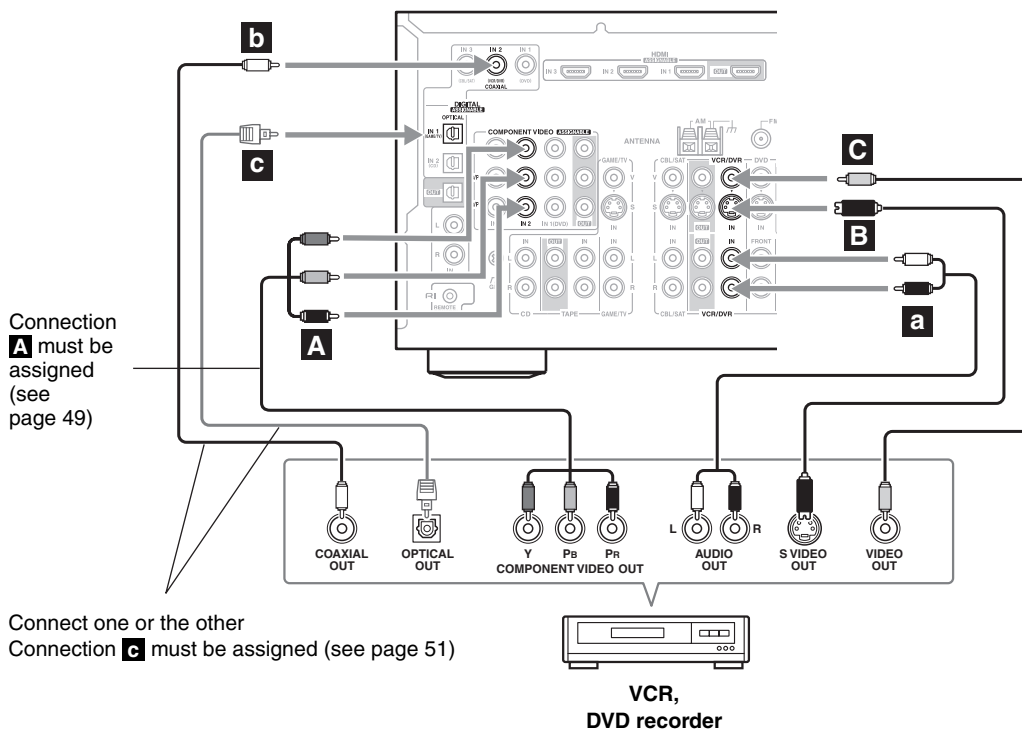

## Connecting the AV Receiver/AV Amplifier—Continued

### Connecting a VCR or DVD Recorder for Recording

#### Step 1: Video Connection

Choose a video connection that matches your VCR or DVD recorder (**A** or **B**), and then make the connection. The video source to be recorded must be connected to the AV receiver/AV amplifier via the same type of connection.

#### Step 2: Audio Connection

Choose an audio connection that matches your VCR or DVD recorder (**a** or **b**), and then make the connection.

Connection	AV receiver/AV amplifier	Signal flow	VCR or DVD recorder	Picture quality
<b>A</b>	VCR/DVR OUT S	⇒	S-Video input	Better
<b>B</b>	VCR/DVR OUT V	⇒	Composite video input	Standard
<b>a</b>	VCR/DVR OUT L/R	⇒	Audio L/R input	
<b>b</b>	DIGITAL OPTICAL OUT	⇒	Digital optical input	

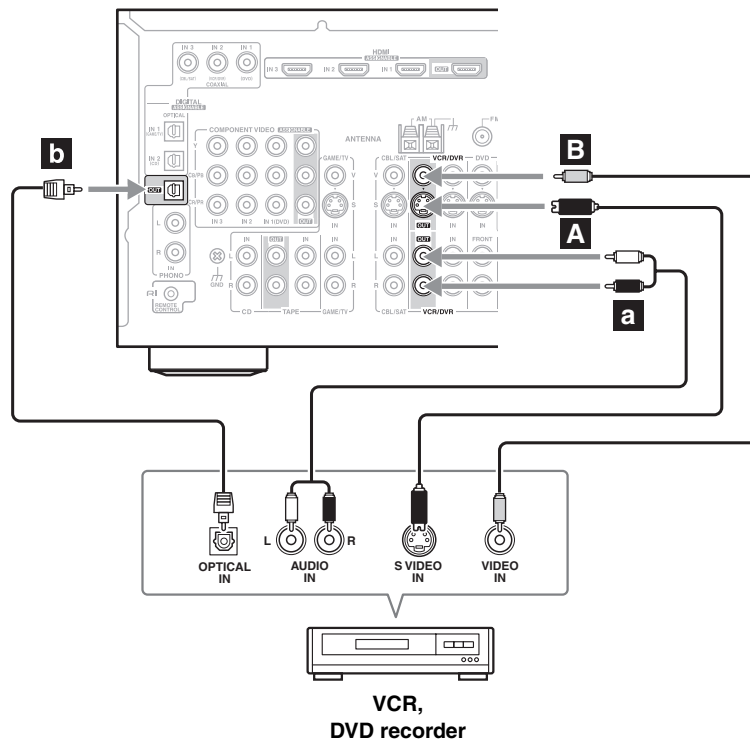

#### Notes:

- The AV receiver/AV amplifier must be turned on for recording. Recording is not possible while it's in Standby mode.
- If you want to record directly from your TV or playback VCR to the recording VCR without going through the AV receiver/AV amplifier, connect the TV/VCR's audio and video outputs directly to the recording VCR's audio and video inputs. See the manuals supplied with your TV and VCR for details.
- Video signals connected to composite video inputs can only be recorded via composite video outputs. If your TV/VCR is connected to a composite video input, the recording VCR must be connected to a composite video output. Similarly, video signals connected to S-Video inputs can only be recorded via S-Video outputs. If your TV/VCR is connected to an S-Video input, the recording VCR must be connected to an S-Video output.

## Connecting the AV Receiver/AV Amplifier—Continued

### Connecting a Satellite, Cable, Set-top box, or Other Video Source



**Hint!**

With this hookup, you can use your satellite or cable receiver to listen to your favorite TV programs via the AV receiver/AV amplifier, useful if your TV has no audio outputs.

#### Step 1: Video Connection

Choose a video connection that matches the video source (**A**, **B**, or **C**), and then make the connection. You must connect the AV receiver/AV amplifier to your TV via the same type of connection.

#### Step 2: Audio Connection

Choose an audio connection that matches the video source (**a**, **b**, or **c**), and then make the connection.

- With connection **a**, you can listen to and record audio from the video source and listen in Zone 2.
- To enjoy Dolby Digital and DTS, use connection **b** or **c**. (For recording, use **a** and **b**, or **a** and **c**.)

Connection	AV receiver/AV amplifier	Signal flow	Video source	Picture quality
<b>A</b>	COMPONENT VIDEO IN 3	←	Component video output	Best
<b>B</b>	CBL/SAT IN S	←	S-Video output	Better
<b>C</b>	CBL/SAT IN V	←	Composite video output	Standard
<b>a</b>	CBL/SAT IN L/R	←	Analog audio L/R output	
<b>b</b>	DIGITAL COAXIAL IN 3 (CBL/SAT)	←	Digital coaxial output	
<b>c</b>	DIGITAL OPTICAL IN 1 (GAME/TV)	←	Digital optical output	

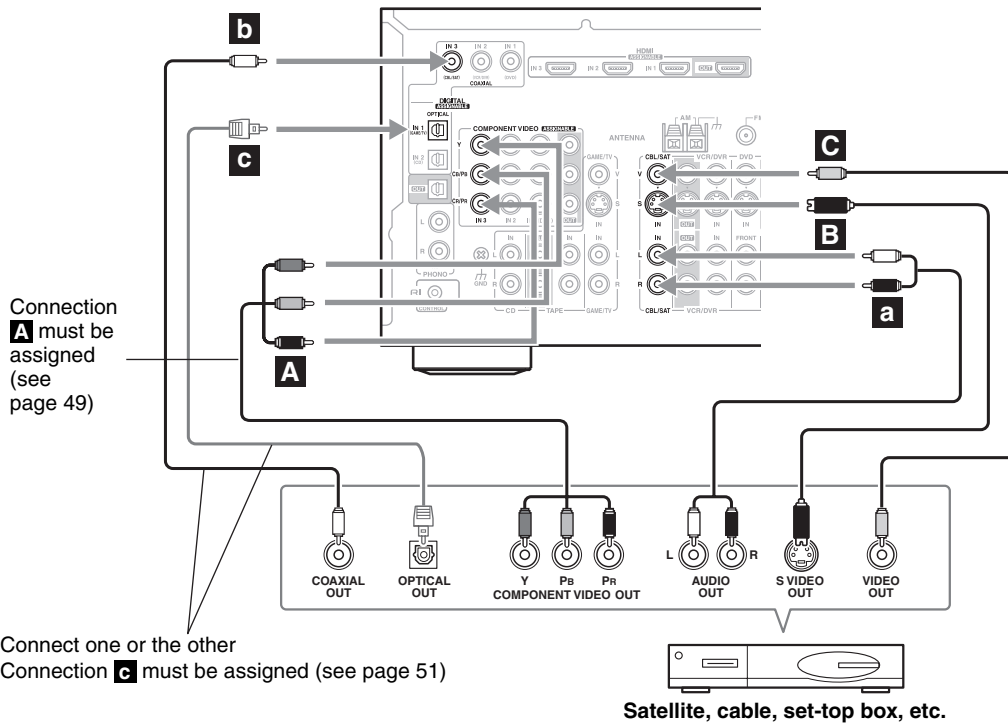

## Connecting the AV Receiver/AV Amplifier—Continued

### Connecting a Game Console

#### Step 1: Video Connection

Choose a video connection that matches the game console (**A**, **B**, or **C**), and then make the connection. If you use connection **A**, you must connect the AV receiver/AV amplifier to your TV with the same type of connection.

#### Step 2: Audio Connection

Choose an audio connection that matches the game console (**a** or **b**), and then make the connection.

- With connection **a**, you can listen to and record audio from the game console or listen in Zone 2.
- To enjoy Dolby Digital and DTS, use connection **b**. (To record or listen in Zone 2 as well, use **a** and **b**.)

Connection	AV receiver/AV amplifier	Signal flow	Game console	Picture quality
<b>A</b>	COMPONENT VIDEO IN 3	←	Component video output	Best
<b>B</b>	GAME/TV IN S	←	S-Video output	Better
<b>C</b>	GAME/TV IN V	←	Composite video output	Standard
<b>a</b>	GAME/TV IN L/R	←	Analog audio L/R output	
<b>b</b>	DIGITAL OPTICAL IN 1 (GAME/TV)	←	Digital optical output	

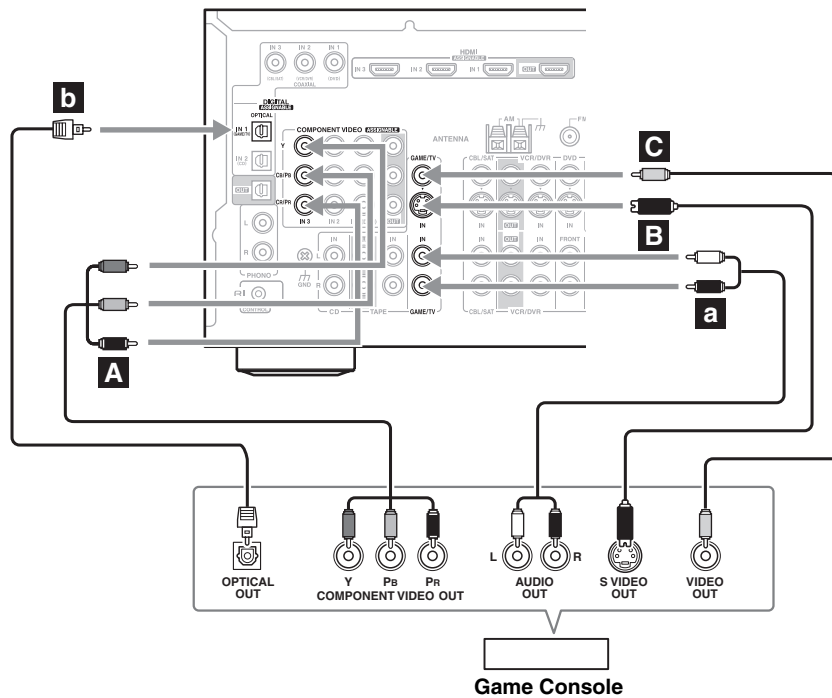

## Connecting the AV Receiver/AV Amplifier—Continued

### Connecting a Camcorder or Other Device

#### Step 1: Video Connection

Choose a video connection that matches the camcorder (**A** or **B**), and then make the connection.

#### Step 2: Audio Connection

Choose an audio connection that matches the camcorder (**a** or **b**), and then make the connection.

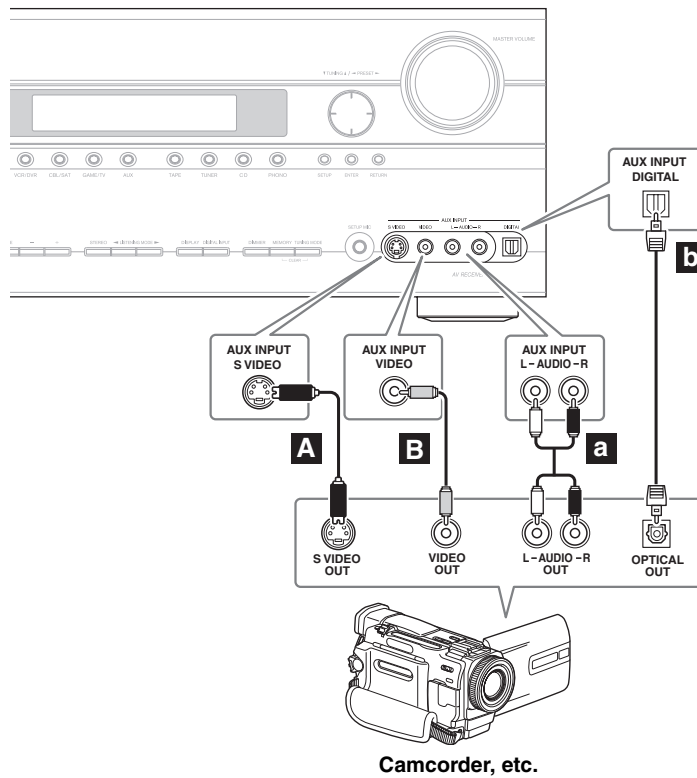

Connection	AV receiver/AV amplifier	Signal flow	Camcorder or console
<b>A</b>	AUX INPUT S VIDEO	←	S-Video output
<b>B</b>	AUX INPUT VIDEO	←	Composite video output
<b>a</b>	AUX INPUT L/R	←	Analog audio L/R output
<b>b</b>	AUX INPUT DIGITAL	←	Digital optical output

## Connecting the AV Receiver/AV Amplifier—Continued

### Connecting Components with HDMI

#### About HDMI

Designed to meet the demands of digital TV, HDMI (High Definition Multimedia Interface) is a new digital interface standard for connecting TVs, projectors, DVD players, set-top boxes, and other video components. Until now, several separate video and audio cables have been required to connect AV components. With HDMI, a single cable can carry control signals, digital video, and up to eight channels of digital audio (2-channel PCM, multichannel digital audio, and multichannel PCM).

The HDMI video stream (i.e., video signal) is compatible with DVI (Digital Visual Interface)<sup>\*1</sup>, so TVs and displays with a DVI input can be connected by using an HDMI-to-DVI adapter cable. (This may not work with some TVs and displays, resulting in no picture.)

The AV receiver/AV amplifier uses HDCP (High-bandwidth Digital Content Protection)<sup>\*2</sup>, so only HDCP-compatible components can display the picture.

The AV receiver/AV amplifier's HDMI interface is based on the following standard:  
High-Definition Multimedia Interface Specification Informational Version 1.3a

#### Supported Audio Formats

- 2-channel linear PCM (32–192 kHz, 16/20/24 bit)
- Multichannel linear PCM (up to 7.1 ch, 32–192 kHz, 16/20/24 bit)
- Bitstream (Dolby Digital, Dolby Digital Plus, Dolby TrueHD, DTS, DTS-HD High Resolution Audio, DTS-HD Master Audio)

Your DVD player must also support HDMI output of the above audio formats.

#### About Copyright Protection

The AV receiver/AV amplifier supports HDCP (High-bandwidth Digital Content Protection)<sup>\*2</sup>, a copy-protection system for digital video signals. Other devices connected to the AV receiver/AV amplifier via HDMI must also support HDCP.

Commercially available HDMI cables (supplied with some components) should be used to connect the AV receiver/AV amplifier's HDMI OUT to the HDMI input on your TV or projector.

\*1 DVI (Digital Visual Interface): The digital display interface standard set by the DDWG<sup>\*3</sup> in 1999.

\*2 HDCP (High-bandwidth Digital Content Protection): The video encryption technology developed by Intel for HDMI/DVI. It's designed to protect video content and requires a HDCP-compatible device to display the encrypted video.

\*3 DDWG (Digital Display Working Group): Led by Intel, Compaq, Fujitsu, Hewlett Packard, IBM, NEC, and Silicon Image, this open industry group's objective is to address the industry's requirements for a digital connectivity specification for high-performance PCs and digital displays.



## Connecting the AV Receiver/AV Amplifier—Continued

### Connecting a CD Player or Turntable

#### ■ CD Player or Turntable (MM) with Built-in Phono Preamp

##### Step 1:

Choose a connection that matches your CD player (**a**, **b**, or **c**). Use connection **a** for a turntable with a built-in phono preamp.

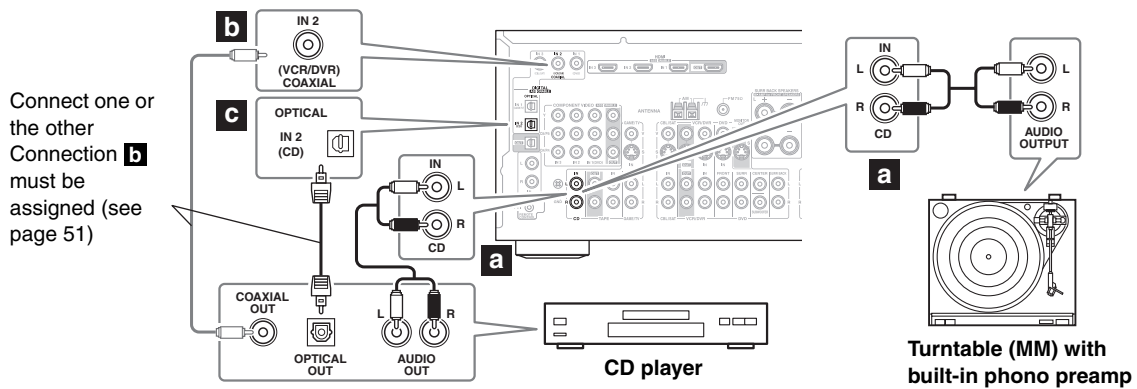

- With connection **a**, you can listen to and record audio from the CD player and listen in Zone 2.
- To connect the CD player digitally, use connection **b** or **c**. (For recording, use **a** and **b**, or **a** and **c**.)

Connection	AV receiver/AV amplifier	Signal flow	CD or turntable
<b>a</b>	CD IN L/R	←	Analog audio L/R output
<b>b</b>	DIGITAL COAXIAL IN 2 (VCR/DVR)	←	Digital coaxial output
<b>c</b>	DIGITAL OPTICAL IN 2 (CD)	←	Digital optical output

#### ■ Turntable (MM) with no Phono Preamp Built-in

The AV receiver/AV amplifier's PHONO IN is designed for use with a moving magnet (MM) type cartridge. Use an analog audio cable to connect the AV receiver/AV amplifier's PHONO IN L/R jacks to the audio output on your turntable.

##### Notes:

- If your turntable has a ground wire, connect it to the AV receiver/AV amplifier's GND screw. With some turntables, connecting the ground wire may produce an audible hum. If this happens, disconnect it.
- If your turntable has a moving coil (MC) type cartridge, you'll need a commercially available MC head amp or MC transformer. Connect your turntable to the head amp or transformer, and connect that to the AV receiver/AV amplifier's PHONO IN L/R jacks.
- You can also use a phono equalizer to connect a turntable with an MC-type cartridge. See your phono equalizer's manual for details.

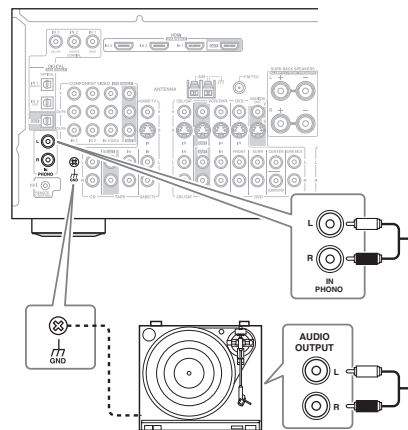

## Connecting the AV Receiver/AV Amplifier—Continued

### Connecting a Cassette, CDR, MiniDisc, or DAT Recorder

#### Step 1:

Choose a connection that matches the recorder (**a**, **b**, **c** or **d**), and then make the connection.

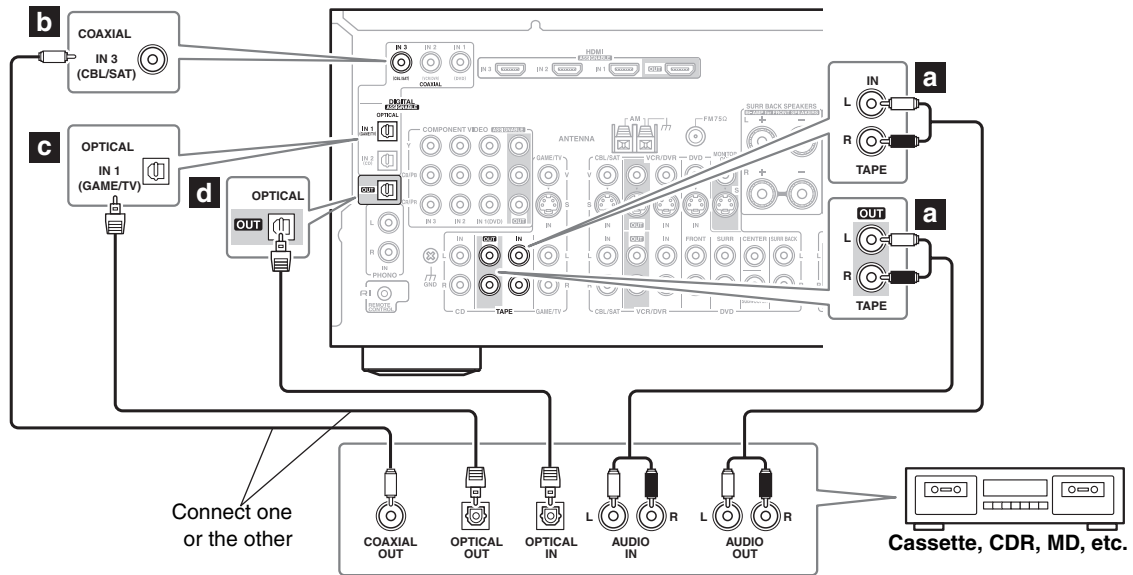

- With connection **a**, you can play and record and listen in Zone 2.
- To connect the recorder digitally for playback, use connections **a** and **b**, or **a** and **c**.
- To connect the recorder digitally for recording, use connection **d**.

Connection	AV receiver/AV amplifier	Signal flow	Cassette, CDR, MD, or DAT recorder
<b>a</b>	TAPE IN L/R TAPE OUT L/R	← →	Analog audio L/R output Analog audio L/R input
<b>b</b>	DIGITAL COAXIAL IN 3 (CBL/SAT)	←	Digital coaxial output
<b>c</b>	DIGITAL OPTICAL IN 1 (GAME/TV)	←	Digital optical output
<b>d</b>	DIGITAL OPTICAL OUT	→	Digital optical input

## Connecting the AV Receiver/AV Amplifier—Continued

### Connecting a Power Amplifier

If you want to use a more powerful power amplifier and use the AV receiver/AV amplifier as a preamp, connect it to the PRE OUT jacks, and connect all speakers and the subwoofer to the power amplifier. If you have a powered subwoofer, connect it to this AV receiver/AV amplifier's PRE OUT SUBWOOFER jack.

1. Subwoofer
2. Front left speaker
3. Center speaker
4. Front right speaker
5. Surround left speaker
6. Surround right speaker
7. Surround back left speaker
8. Surround back right speaker

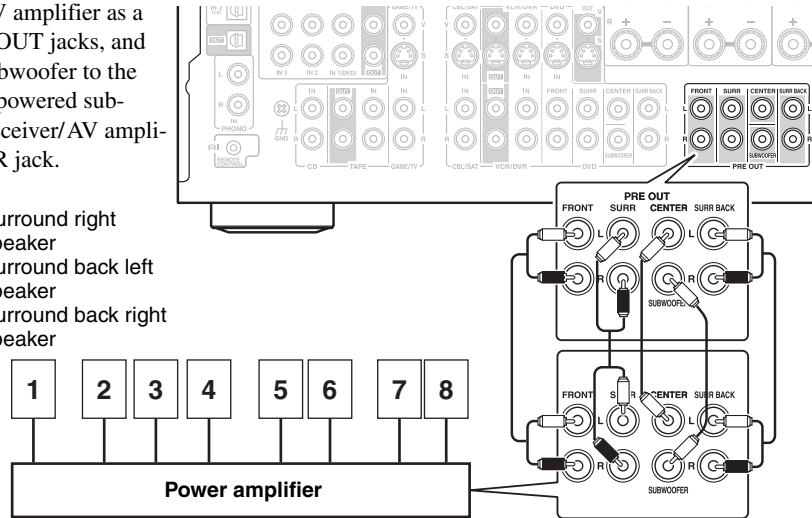

### Connecting a Tuner (TX-SA705 only)

#### Audio Connection

Connect your tuner's analog audio output jacks to the AV amplifier's TUNER L/R IN jacks with an audio cable.

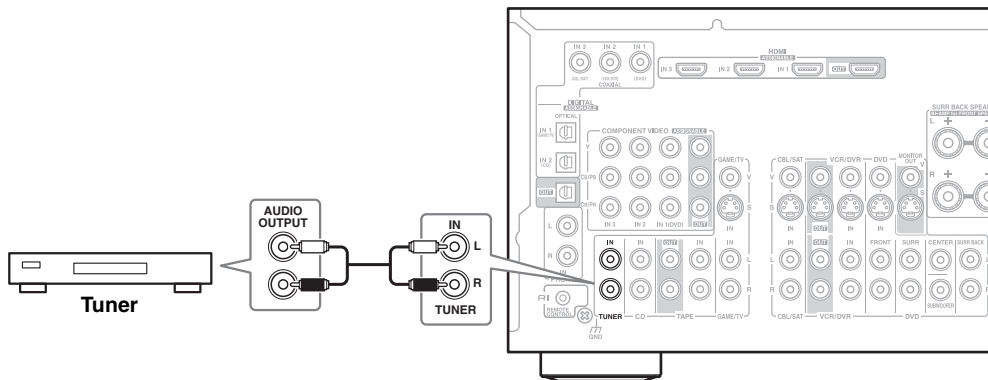

## Connecting the AV Receiver/AV Amplifier—Continued

### Connecting an RI Dock

#### ■ RI Dock with video

Connect your RI Dock's analog audio output jacks and Video output jack to the AV receiver/AV amplifier's GAME/TV IN L/R jacks and GAME/TV IN V jack. (Onkyo DS-A2 hookup shown below.)

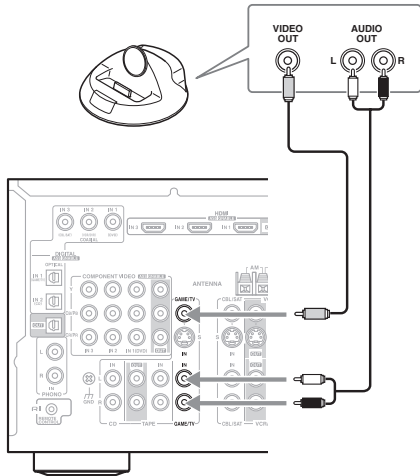

#### ■ RI Dock without video

Connect your RI Dock's analog audio output jacks to the AV receiver/AV amplifier's TAPE IN L/R jacks. (Onkyo DS-A2 hookup shown below.)

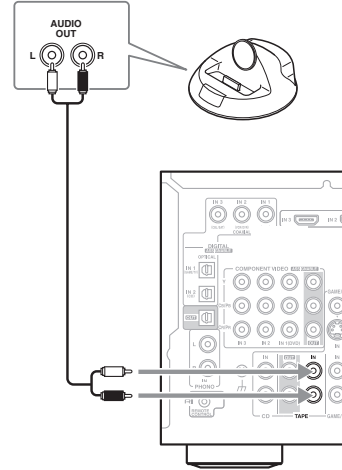

#### ■ If you have an Onkyo DS-A1 RI Dock

- Connect its video output jack to the AV receiver/AV amplifier's GAME/TV IN S jack.
- Enter the appropriate remote control code before using the AV receiver/AV amplifier's remote controllers for the first time (see page 104).

#### Notes:

- Connect the Remote Interactive Dock with an **RI** cable (see page 43).
- Set the Remote Interactive Dock's RI MODE switch to HDD or HDD/DOCK.
- Set the AV receiver/AV amplifier's input display to DOCK (see page 50).
- Refer to the Remote Interactive Dock's instruction manual.

### Connecting the Power Cords of Other Components (North American and European models only)

The AV receiver has AC outlets on its rear panel that can be used to connect the power cords of other components that you intend to use with the AV receiver. These components can then be left turned on so that they turn on and off as and when the AV receiver is set to On or Standby.

#### Caution:

- Make sure that the total capacity of the components that you connect to the AC OUTLETS does not exceed the stated capacity (e.g., TOTAL 120 W).

#### Notes:

- Onkyo components connected via **RI** should be connected directly to a wall outlet, not an AC OUTLET on the AV receiver.
- The number of AC OUTLETS, socket type, and total capacity depends on the country in which you purchased the AV receiver.

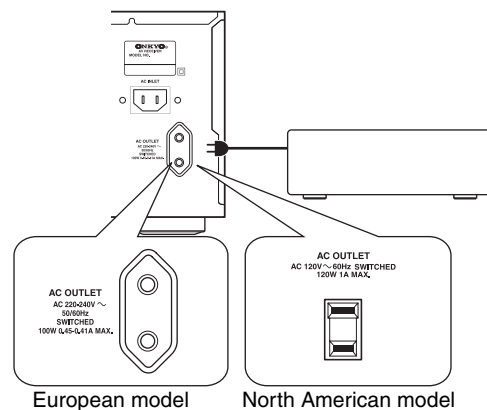

## Connecting the AV Receiver/AV Amplifier—Continued

### Connecting Onkyo **RI** Components

**Step 1:** Make sure that each Onkyo component is connected to the AV receiver/AV amplifier with an analog audio cable (connection **a** in the hookup examples) (see pages 29 to 40).

**Step 2:** Make the **RI** connection.

**Step 3:** If you're using an MD, CDR, or RI Dock, change the input display (see page 50).

With **RI** (Remote Interactive), you can use the following special functions:

#### ■ Auto Power On/Standby

When you start playback on a component connected via **RI**, if the AV receiver/AV amplifier is on Standby, it will automatically turn on and select that component as the input source. Similarly, when the AV receiver/AV amplifier is set to Standby, all components connected via **RI** will also go on Standby.

#### ■ Direct Change

When playback is started on a component connected via **RI**, the AV receiver/AV amplifier automatically selects that component as the input source. If your DVD player is connected to the AV receiver/AV amplifier's multichannel DVD input, you'll need to press the [MULTI CH] button to hear all channels (see page 60), as the Direct Change **RI** function only selects the DVD FRONT L/R jacks.

#### ■ Remote Control

You can use the AV receiver/AV amplifier's remote controller to control your other **RI**-capable Onkyo components, pointing the remote controller at the AV receiver/AV amplifier's remote control sensor instead of the component. You must enter the appropriate remote control code first (see page 105).

#### Notes:

- Use only **RI** cables for **RI** connections. **RI** cables are supplied with Onkyo players (DVD, CD, etc.).
- Some components have two **RI** jacks. You can connect either one to the AV receiver/AV amplifier. The other jack is for connecting additional **RI**-capable components.
- Connect only Onkyo components to **RI** jacks. Connecting other manufacturer's components may cause a malfunction.
- Some components may not support all **RI** functions. Refer to the manuals supplied with your other Onkyo components.
- While Zone 2 is on, the Auto Power On/Standby and Direct Change **RI** functions do not work.

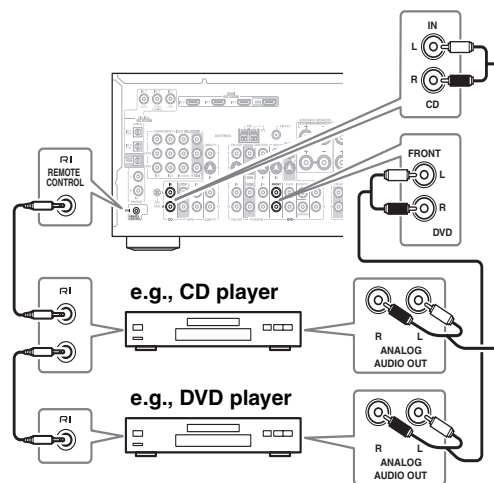

### Connecting the RS232 Port

This port is for connecting the AV receiver/AV amplifier to home automation equipment and external controllers.

### Connecting the Power Cord

#### Notes:

- **Before connecting the power cord, connect all of your speakers and AV components.**
- Turning on the AV receiver/AV amplifier may cause a momentary power surge that might interfere with other electrical equipment on the same circuit. If this is a problem, plug the AV receiver/AV amplifier into a different branch circuit.
- Do not use a power cord other than the one supplied with the AV receiver/AV amplifier. The supplied power cord is designed exclusively for use with the AV receiver/AV amplifier and should not be used with any other equipment.
- Never disconnect the power cord from the AV receiver/AV amplifier while the other end is still plugged into a wall outlet. Doing so may cause an electric shock. Always disconnect the power cord from the wall outlet first, and then the AV receiver/AV amplifier.

#### Step 1 (not North American model):

Connect the supplied power cord to the AV receiver/AV amplifier's AC INLET.

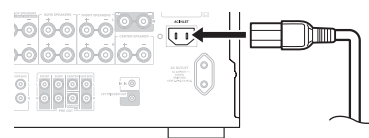

To AC wall outlet

**Step 2:** Plug the power cord into an AC wall outlet. (The Standby indicator lights up.)

# Turning On the AV Receiver/AV Amplifier

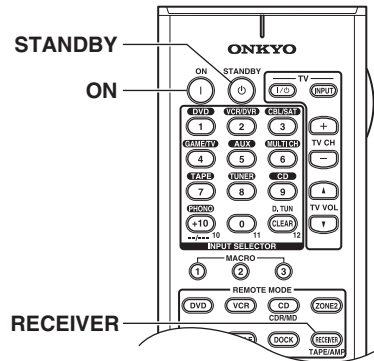
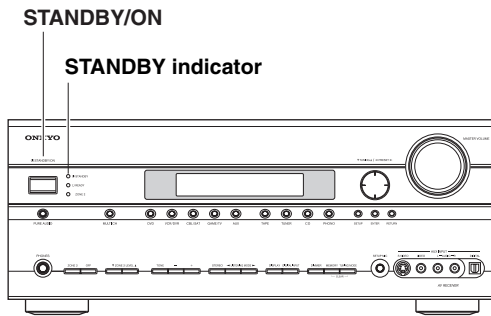

## Turning On and Standby

1

AV receiver/  
AV amplifier



Remote  
controller



Press the [STANDBY/ON] button.

Alternatively, press the remote controller's [RECEIVER] button, followed by the [ON] button.

The AV receiver/AV amplifier comes on, the display lights up, and the STANDBY indicator goes off.

Pressing the remote controller's [ON] button again will turn on any components connected via **RI**.

To turn the AV receiver/AV amplifier off, press the [STANDBY/ON] button, or press the remote controller's [STANDBY] button. The AV receiver/AV amplifier will enter Standby mode. To prevent any loud surprises when you turn on the AV receiver/AV amplifier, always turn down the volume before you turn it off.

## Smooth Operation in a Few Easy Steps

To ensure smooth operation, here's a few easy steps to help you configure the AV receiver/AV amplifier before you use it for the very first time. These settings only need to be made once.

■ **Do the automatic speaker setup—this is essential!**

See "Automatic Speaker Setup (Audyssey MultEQ XT)" on page 54.



■ **Have you connected a component to an HDMI input, component video input, or digital audio input?**

If you have, see "HDMI Input Setup" on page 48, "Component Video Setup" on page 49, or "Digital Input Setup" on page 51 respectively.

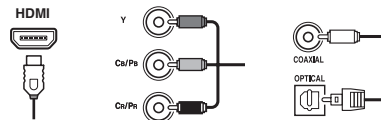

■ **Have you connected an Onkyo MD recorder, CD recorder, or RI Dock?**

If you have, see "Changing the Input Display" on page 50.

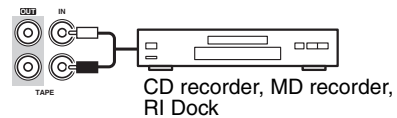

# First Time Setup

This section explains the settings that you need to make before using the AV receiver/AV amplifier for the very first time.

## ■ Menus for First Time Setup

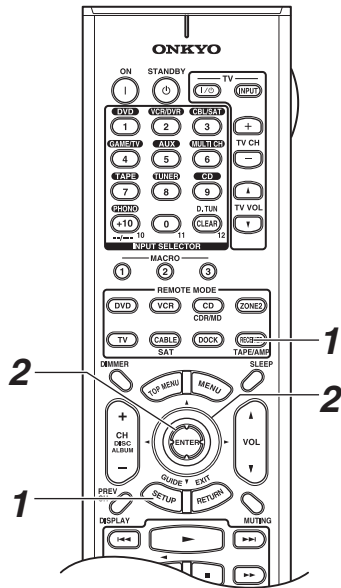

### Using the Onscreen Setup Menus

Carry out the settings for the AV receiver/AV amplifier by using the Onscreen Setup Menu.

**1**



**Press the [RECEIVER] button followed by the [SETUP] button.**  
The main menu appears onscreen.

Menu

1. Input/Output Assign
2. Speaker Setup
3. Audio Adjust
4. Source Setup
5. Listening Mode Preset
6. Miscellaneous
7. Hardware Setup
8. Lock Setup

**2**



**Use the Up and Down [▲]/[▼] buttons to select submenu and then press [ENTER].**  
The submenu appears.  
Press the [SETUP] button to close the menu.

### Submenus

1. Input/Output Assign p. 47

1. Monitor Out p. 51
2. HDMI Input
3. Component Video Input
4. Digital Input

2. Speaker Setup p. 46

1. Speaker Settings
2. Speaker Config
3. Speaker Distance
4. Level Calibration
5. Equalizer Settings
6. THX Audio Setup

6. Miscellaneous p. 52

1. Volume Setup
2. OSD Setup

7. Hardware Setup p. 53

1. Remote Control
2. Zone2
3. Tuner
4. Analog Multich
5. HDMI

### Main menu

Menu

1. Input/Output Assign
2. Speaker Setup
3. Audio Adjust
4. Source Setup
5. Listening Mode Preset
6. Miscellaneous
7. Hardware Setup
8. Lock Setup

## First Time Setup—Continued

### Speaker Settings

If you change these settings, you must run the automatic speaker setup again (see page 54).

If the impedance of any speaker is 4 ohms or more but less than 6, set the minimum speaker impedance to 4 ohms (not North American models).

If you've connected your front speakers to the FRONT SPEAKERS and SURR BACK SPEAKERS terminal posts for bi-amping, you must change the Speakers Type setting. For hookup information, see "Bi-amping the Front Speakers" on page 24.

#### Notes:

- When bi-amping is used, the AV receiver/AV amplifier is able to drive up to 5.1 speakers in the main room.
- Before you change these settings, turn down the volume.

**1**



Press the [RECEIVER] button, followed by the [SETUP] button. The main menu appears onscreen.

**2**



Use the Up and Down [▲]/[▼] buttons to select "2. Speaker Setup," and then press [ENTER]. The Speaker Setup menu appears.

2. Speaker Setup	
1. Speaker Settings	
2. Speaker Config	
3. Speaker Distance	
4. Level Calibration	
5. Equalizer Settings	
6. THX Audio Setup	

**3**



Use the Up and Down [▲]/[▼] buttons to select "1. Speaker Settings," and then press [ENTER]. The Speaker Settings menu appears.

2-1. Speaker Settings	
Speaker Impedance	◀ 6 ohms ▶
Speakers Type	◀ Normal ▶

**4**



Use the Up and Down [▲]/[▼] buttons to select "Speaker Impedance," and then use the Left and Right [◀]/[▶] buttons to select:

**4 ohms:** Select if the impedance of any speaker is 4 ohms or more but less than 6.

**6 ohms:** Select if the impedances of all speakers are between 6 and 16 ohms.

**5**



Use the Up and Down [▲]/[▼] buttons to select "Speakers Type," and then use the Left and Right [◀]/[▶] buttons to select:

**Normal:** Select this if you've connected your front speakers normally.

**Bi-Amp:** Select this if you've connected your front speakers for bi-amped operation.

**6**



Press the [SETUP] button. The Setup menu closes.

#### Note:

This procedure can also be performed on the AV receiver/AV amplifier by using its [SETUP] button, arrow buttons, and [ENTER] button.

## First Time Setup—Continued

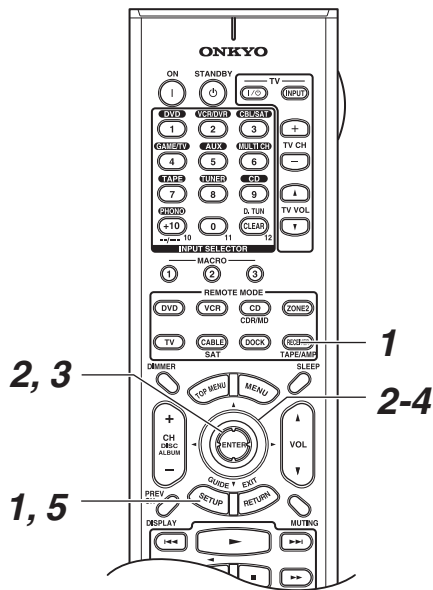

### HDMI Monitor Setup

If you connect your TV to the COMPONENT VIDEO OUT, set the HDMI Monitor setting to No so that the onscreen setup menus are displayed and composite video and S-Video sources are upconverted\* and output by the COMPONENT VIDEO OUT.

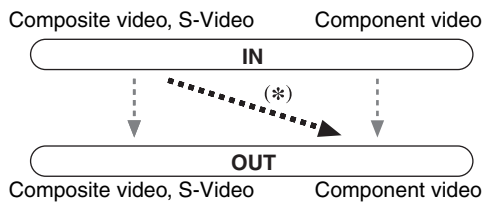

If you connect your TV to the HDMI OUT, set the HDMI Monitor setting to Yes so that the onscreen setup menus are displayed and composite video, S-Video, and component video sources are upconverted\* and output by the HDMI OUT. The onscreen setup menus are displayed on the HDMI OUT only.

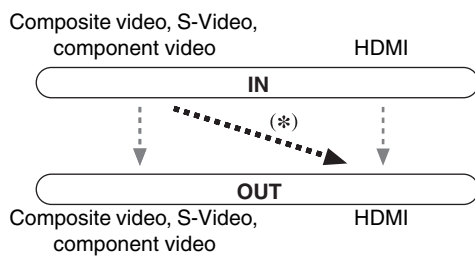

- 1** Press the [RECEIVER] button followed by the [SETUP] button.  
The main menu appears onscreen.
- 2** Use the Up and Down [▲]/[▼] buttons to select "1. Input/Output Assign," and then press [ENTER].  
The Input/Output Assign menu appears.

1. Input/Output Assign	
1. Monitor Out	
2. HDMI Input	
3. Component Video Input	
4. Digital Input	
- 3** Use the Up and Down [▲]/[▼] buttons to select "1. Monitor Out," and then press [ENTER].  
The Monitor Out menu appears.

1-1. Monitor Out	
HDMI Monitor	◀ No ▶
- 4** Use the Left and Right [◀]/[▶] buttons to select:  
**No:** Select this if your TV is connected to the MONITOR OUT or COMPONENT VIDEO OUT.  
**Yes:** Select this if your TV is connected to the HDMI OUT.
- 5** Press the [SETUP] button.  
The Setup menu closes.

**Note:**

This procedure can also be performed on the AV receiver/AV amplifier by using its [SETUP] button, arrow buttons, and [ENTER] button.

## First Time Setup—Continued

### Video Input Setup

#### HDMI Input Setup

If you connect a video component to HDMI IN, you must assign that input to an input selector. For example, if you connect your DVD player to HDMI IN 1, you must assign HDMI IN 1 to the DVD input selector.

If you've connected your TV to the AV receiver/AV amplifier with an HDMI cable, you can set the AV receiver/AV amplifier so that composite video, S-Video, and component video sources are upconverted\* and output by the HDMI OUT. You can set this for each input selector by selecting the "--" option.

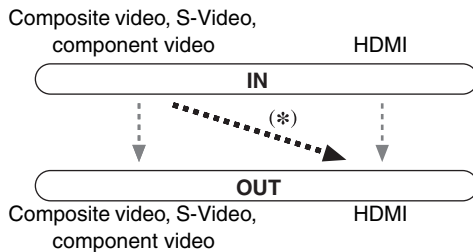

**1** Press the [RECEIVER] button followed by the [SETUP] button. The main menu appears onscreen.



**2** Use the Up and Down [▲]/[▼] buttons to select "1. Input/Output Assign," and then press [ENTER]. The Input/Output Assign menu appears.

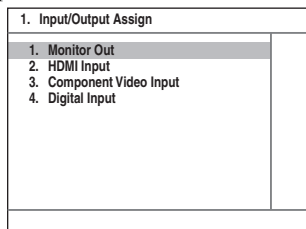

**3** Use the Up and Down [▲]/[▼] buttons to select "2. HDMI Input," and then press [ENTER]. The HDMI Input menu appears.

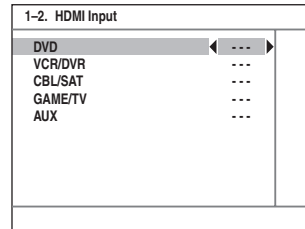
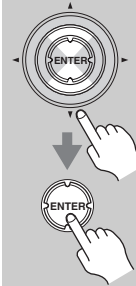

**4** Use the Up and Down [▲]/[▼] buttons to select an input selector, and use the Left and Right [◀]/[▶] buttons to select:

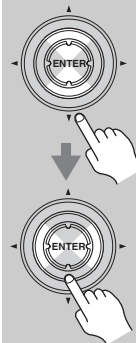

- IN 1:** Select if the video component is connected to HDMI IN 1.
- IN 2:** Select if the video component is connected to HDMI IN 2.
- IN 3:** Select if the video component is connected to HDMI IN 3.
- :** Output composite video, S-Video, and component video sources from the HDMI OUT. The video output signal from the HDMI OUT is the one configured in "Component Video Setup" (see page 49).

**5** Press the [SETUP] button. The Setup menu closes.



#### Notes:

- Each HDMI IN cannot be assigned to more than one input selector.
- For composite video, S-Video, and component video upconversion for the HDMI OUT, the HDMI Monitor setting must be set to Yes (see page 47), and the HDMI Input setting must be set to "--". See page 27 for more information on video signal flow and upconversion.
- When an HDMI IN is assigned to an input selector as explained here, the digital audio input for that input selector is automatically set to the same HDMI IN. See "Digital Input Setup" on page 51.
- This procedure can also be performed on the AV receiver/AV amplifier by using its [SETUP] button, arrow buttons, and [ENTER] button.

## First Time Setup—Continued

### Component Video Setup

If you connect to a COMPONENT VIDEO IN, you must assign it to an input selector. For example, if you connect your DVD player to COMPONENT IN 3, you should assign it to the DVD input selector.

If you want to output composite and S-Video sources from the COMPONENT VIDEO OUT, select “---,” as explained below.

Input selector	VIDEO IN jack
DVD	IN 1
VCR/DVR	---
CBL/SAT	---
GAME/TV	---
AUX	---

If you’ve connected your TV to the AV receiver/AV amplifier with a component video cable, you can set the AV receiver/AV amplifier so that composite video and S-Video sources are upconverted\* and output by the COMPONENT VIDEO OUT.

You can set this for each input selector by selecting the “- - -” option.

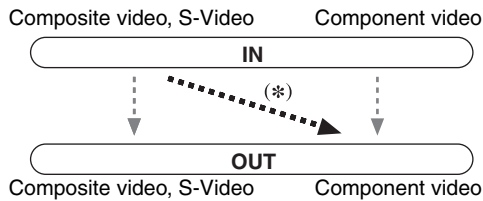

**1** Press the [RECEIVER] button followed by the [SETUP] button. The main menu appears onscreen.



**2** Use the Up and Down [▲]/[▼] buttons to select “1. Input/Output Assign,” and then press [ENTER].

The Input/Output Assign menu appears.

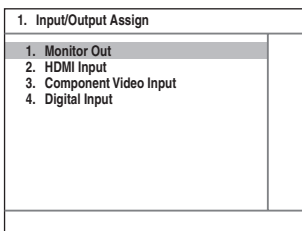

**3** Use the Up and Down [▲]/[▼] buttons to select “3. Component Video Input,” and then press [ENTER].

The Component Video Input menu appears.

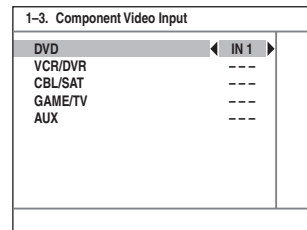

**4** Use the Up and Down [▲]/[▼] buttons to select an input selector, and then use the Left and Right [◀]/[▶] buttons to select:

**IN 1:** Use the video component connected to COMPONENT VIDEO IN 1.

**IN 2:** Use the video component connected to COMPONENT VIDEO IN 2.

**IN 3:** Use the video component connected to COMPONENT VIDEO IN 3.

**---**: Output composite video and S-Video sources from the COMPONENT VIDEO OUT.

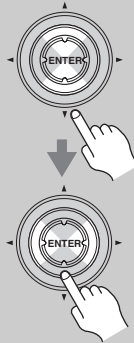

**5** Press the [SETUP] button. The setup menu closes.



#### Notes:

- For composite video and S-Video upconversion for the COMPONENT VIDEO OUT, the HDMI Monitor setting must be set to No (see page 47), and the Component Video Input setting must be set to “- - -”. See page 28 for more information on video signal flow and upconversion.
- This procedure can also be performed on the AV receiver/AV amplifier by using its [SETUP] button, arrow buttons, and [ENTER] button.

## First Time Setup—Continued

### Changing the Input Display

If you connect an **RI**-capable Onkyo MiniDisc recorder, CD recorder, or RI Dock to the TAPE IN/OUT or GAME/TV IN jacks, for **RI** to work properly, you must change this setting.

This setting can only be changed on the AV receiver/AV amplifier.

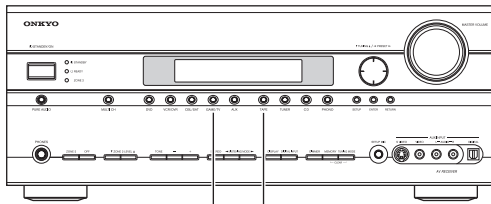

**1, 2 1, 2**

**iPod photo:** If you're using an iPod photo with the RI Dock, connect the RI Dock to the GAME/TV IN jacks.

<p><b>1</b></p> <p>TAPE</p> <p>or</p> <p>GAME/TV</p>	<p><b>Press the [TAPE] or [GAME/TV] input selector button so that "TAPE" or "GAME/TV" appears on the display.</b></p> <div style="border: 1px solid black; padding: 2px; margin: 5px 0; text-align: center;">TAPE</div> <div style="border: 1px solid black; padding: 2px; margin: 5px 0; text-align: center;">GAME/TV</div>
<p><b>2</b></p> <p>TAPE</p> <p>or</p> <p>GAME/TV</p>	<p><b>Press and hold down the [TAPE] or [GAME/TV] input selector button (about 3 seconds) to change the setting.</b></p> <p>Repeat this step to select MD, CDR, or DOCK.</p> <p>For the TAPE input selector, the setting changes in this order:</p> <p style="text-align: center;">TAPE → MD → CDR → DOCK</p> <p style="text-align: center;">↑—————↓</p> <p>For the GAME/TV input selector, the setting changes in this order:</p> <p style="text-align: center;">GAME/TV ↔ DOCK</p>

**Note:**

DOCK can be selected for the TAPE input selector or GAME/TV input selector, but not both at the same time.

## First Time Setup—Continued

### Digital Input Setup

If you connect a component to a digital input jack, you must assign that jack to an input selector. For example, if you connect your CD player to the OPTICAL IN2 jack, you should assign that jack to the CD input selector. By default, the COAXIAL IN1 jack is assigned to the DVD input selector, although this can be changed.

Here are the default assignments.

Input selector	Default assignment
DVD	COAX 1
VCR/DVR	COAX 2
CBL/SAT	COAX 3
GAME/TV	OPT 1
AUX	FRONT
TAPE	---
TUNER (TX-SA705 only)	---
CD	OPT 2
PHONO	---

When HDMI IN 1, 2 or 3 is assigned to an input selector in the “HDMI Input Setup” on page 48, the input selector assignment on this page is automatically set to HDMI 1, HDMI 2 or HDMI 3.



**1 Press the [RECEIVER] button followed by the [SETUP] button.**  
The main menu appears onscreen.



**2 Use the Up and Down [▲]/[▼] buttons to select “1. Input/Output Assign,” and then press [ENTER].**  
The Input/Output Assign menu appears.

1. Input/Output Assign	
1. Monitor Out	
2. HDMI Input	
3. Component Video Input	
4. Digital Input	



**3 Use the Up and Down [▲]/[▼] buttons to select “4. Digital Input,” and then press [ENTER].**  
The Digital Input menu appears.

1-4. Digital Input	
DVD	◀ COAX 1 ▶
VCR/DVR	COAX 2
CBL/SAT	COAX 3
GAME/TV	OPT 1
AUX	FRONT
TAPE	---
TUNER	---
CD	OPT 2
PHONO	---

**4**

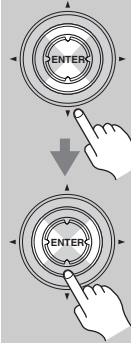

**Use the Up and Down [▲]/[▼] buttons to select an input selector, and use the Left and Right [◀]/[▶] buttons to select COAX 1, COAX 2, COAX 3, OPT 1, OPT 2, or --- (analog).**

- An input selector that has been assigned to IN 1, IN 2 or IN 3 in the “HDMI Input Setup” (see page 48) can be set to HDMI here.
- AUX is used only for digital input from the front panel terminals. When HDMI IN 1, 2 or 3 is assigned to AUX in the “HDMI Input Setup” on page 48, IN 1, IN 2 or IN 3 can be selected.

#### Examples:

If you connect your DVD player to the OPTICAL IN 1 jack, set “DVD” to “OPT 1.”

If you want to listen to audio from the component connected to the OPTICAL IN 2 jack when the VCR/DVR input selector is selected, set “VCR/DVR” to “OPT 2.”

If you want to listen to audio from the component connected to the COAXIAL IN 1 jack when the CBL/SAT input selector is selected, set “CBL/SAT” to “COAX 1.”

For input selectors that you don’t want to assign a digital input jack, set to “--- (analog).”

**5**



**Press the [SETUP] button.**  
The Setup menu closes.

#### Notes:

- This procedure can also be performed on the AV receiver/AV amplifier by using its [SETUP] button, arrow buttons, and [ENTER] button.
- This procedure can also be performed on the AV receiver/AV amplifier by using its input selector button and [DIGITAL INPUT] button. First Press the input selector button for the source that you want to assign. Press the [DIGITAL INPUT] button repeatedly to select COAX1, COAX2, COAX3, OPT1, OPT2, or --- (analog).

## First Time Setup—Continued

### TV Format Setup (not North American models)

You must specify the TV system used in your area.

**1**



Press the **[RECEIVER]** button followed by the **[SETUP]** button.

The main menu appears onscreen.

**2**

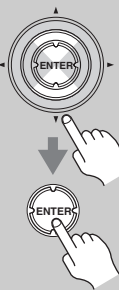

Use the Up and Down **[▲]/[▼]** buttons to select “6. Miscellaneous,” and then press **[ENTER]**.

The Miscellaneous menu appears.

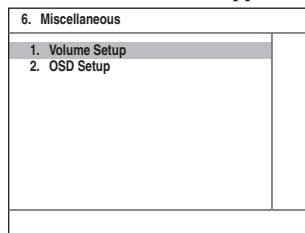

**3**

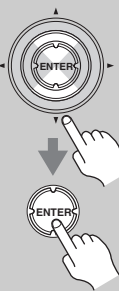

Use the Up and Down **[▲]/[▼]** buttons to select “2. OSD Setup,” and then press **[ENTER]**.

The OSD Setup menu appears.

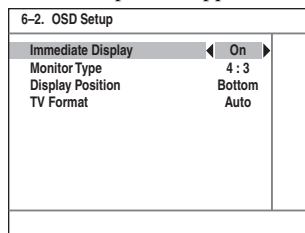

**4**



Use the Up and Down **[▲]/[▼]** buttons to select “TV Format,” and then use the Left and Right **[◀]/[▶]** buttons to select:

- Auto:** Select this to automatically detect the TV system from the video input signals.
- NTSC:** Select if the TV system in your area is NTSC.
- PAL:** Select if the TV system in your area is PAL.

**5**



When you've finished, press the **[SETUP]** button.

The setup menu closes.

**Note:**

This procedure can also be performed on the AV receiver/AV amplifier by using its **[SETUP]** button, arrow buttons, and **[ENTER]** button.







## First Time Setup—Continued

### AM Frequency Step Setup (on some models)

You must specify the AM frequency step used in your area. Note that when this setting is changed, all radio presets are deleted.

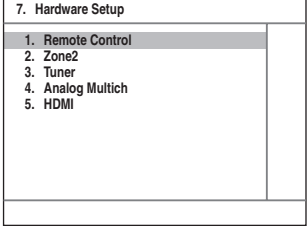
**Note:**

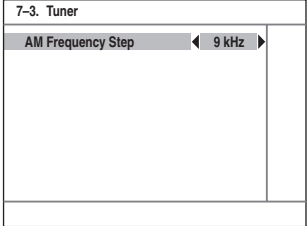
- This procedure can also be performed on the AV receiver/AV amplifier by using its [SETUP] button, arrow buttons, and [ENTER] button.

<p><b>1</b></p> 	<p><b>Press the [RECEIVER] button, followed by the [SETUP] button.</b> The main menu appears onscreen.</p>
<p><b>2</b></p> 	<p><b>Use the Up and Down [▲]/[▼] buttons to select “7. Hardware Setup,” and then press [ENTER].</b> The Hardware Setup menu appears.</p> 
<p><b>3</b></p> 	<p><b>Use the Up and Down [▲]/[▼] buttons to select “3. Tuner,” and then press [ENTER].</b> The Tuner menu appears.</p> 
<p><b>4</b></p> 	<p><b>Use the Left and Right [◀]/[▶] buttons to select:</b></p> <p><b>10 kHz:</b> Select if 10 kHz steps are used in your area.</p> <p><b>9 kHz:</b> Select if 9 kHz steps are used in your area.</p>
<p><b>5</b></p> 	<p><b>Press the [SETUP] button.</b> The Setup menu closes.</p>

## First Time Setup—Continued

### Automatic Speaker Setup (Audyssey MultEQ XT)

With the supplied speaker setup microphone, the Audyssey MultEQ XT function can measure the number of speakers connected, their sizes, crossover frequencies, and the distance from each speaker to the listening position and calculate the optimal speaker settings for your listening environment automatically.

Before using this function, connect and position all of your speakers.

#### Measurement Positions

To create a listening environment in which several people can enjoy your home theater simultaneously, Audyssey MultEQ XT takes measurements at up to eight positions within the listening area.

##### ■ 1st measurement point

This is the center position of your listening area, or the listening position if there's only one listener.

##### ■ 2nd–8th measurement positions

These are the other listening positions (i.e., the places where the other listeners will sit). You can measure up to eight positions.

The following examples show some typical home theater seating arrangements. Choose the one that best matches yours, and position the microphone accordingly when prompted.

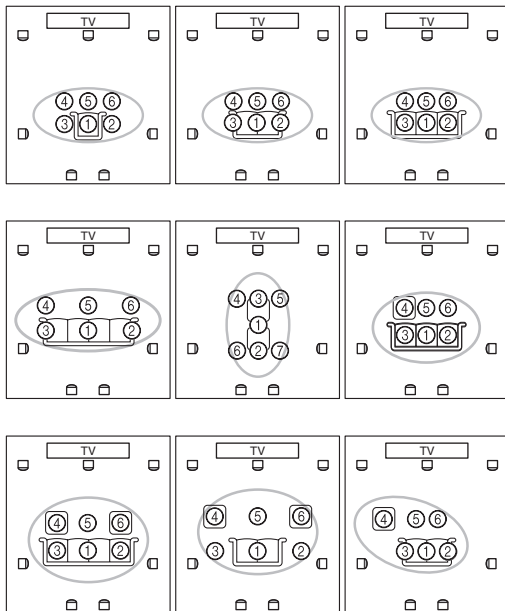

○ : listening area

①–⑦ : listening position

### Using Audyssey MultEQ XT

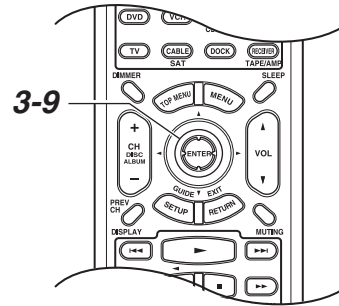
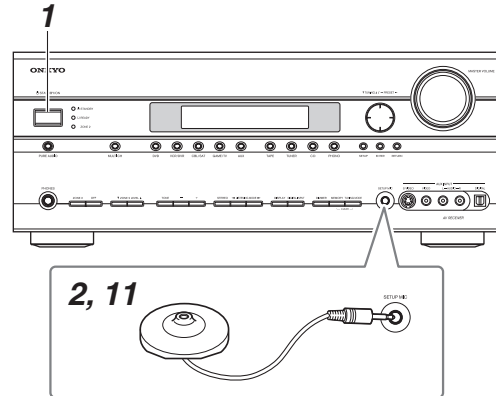

#### Notes:

- If any of your speakers is 4 ohms, change the Speaker Impedance setting before running the automatic speaker setup (see page 46).
- If the AV receiver/AV amplifier is muted, it will be unmuted automatically when the automatic speaker setup starts.
- Automatic speaker setup cannot be performed while a pair of headphones is connected.
- It takes about 15 minutes to complete the automatic speaker setup for three positions. Total measurement time varies depending on the number of positions and speakers.
- Do not disconnect the speaker setup microphone during the automatic speaker setup, unless you want to cancel the setup.
- Do not connect or disconnect any speakers during the automatic speaker setup.

#### 1

#### Turn on the AV receiver/AV amplifier and the connected TV.

On the TV, select the input to which the AV receiver/AV amplifier is connected.

## First Time Setup—Continued

2



Put the speaker setup microphone at measurement point ① (page 54), and connect it to the SETUP MIC jack.

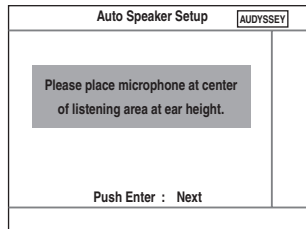

**Notes:**

- Make sure the microphone is horizontal.
- If there's an obstacle between the microphone and any speaker, the automatic setup will not work correctly. Set up the room as you would when enjoying a DVD.
- Positioning the microphone close to where your ears would normally be will provide better results. You can adjust the height of the microphone by using a tripod or level table.

3



**Press [ENTER].**

The automatic speaker setup starts.

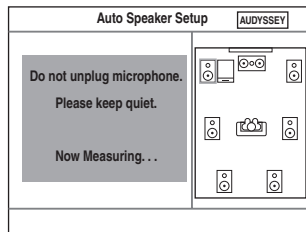

A test tone is output by each speaker in turn, as the Audyssey MultEQ XT function determines which speakers are connected. This takes a few minutes.

**Note:**

If any extraneous noise is picked up by the microphone, the automatic setup may not work correctly, so don't make any noise.

4

The speaker detect results appear.

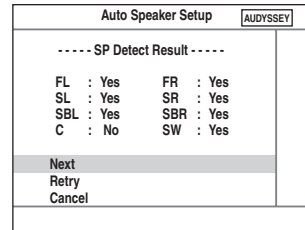

“Yes” means that the speaker was detected. “No” means that no speaker was detected.

**If you agree with the results, use the Up and Down [▲]/[▼] buttons to select Next, and then press [ENTER].**

The options are:

**Next:**

Proceed to the next step.

**Retry:**

Return to step 2 and try again.

**Cancel:**

Cancel the automatic speaker setup.

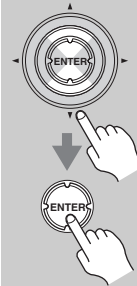

5

The following screen appears.

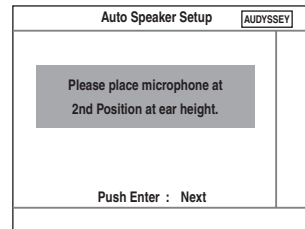

**Place the setup microphone at the next position (page 54), and then press [ENTER].**

Audyssey MultEQ XT performs more measurements. This takes a few minutes.

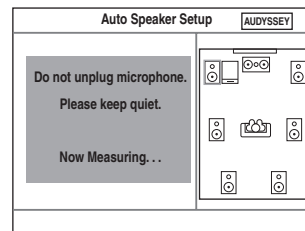

6

**When prompted, place the setup microphone at the next position, and repeat step 5.**

## First Time Setup—Continued

### 7

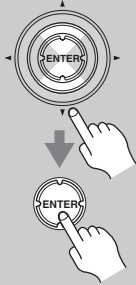

After the 3rd to the 7th measurement, the following screen appears.

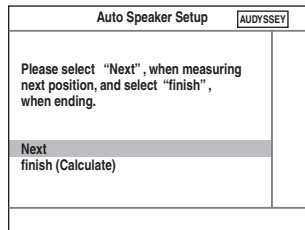

Use the Up and Down [▲]/[▼] buttons to select an option, and then press [ENTER].

**Next:** Select this if you want to measure another listening position.

After the 8th measurement has been taken, the procedure automatically proceeds to step 8.

**finish (Calculate):** Select this if you don't want to measure any more listening positions and are ready to calculate the results, then go to step 8.

### 8

When the measurements are complete, the following screen appears.

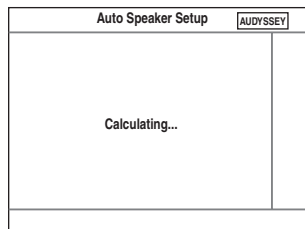

### 9

When the calculations are complete, the following screen appears.

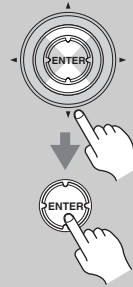
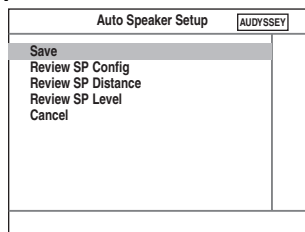

Use the Up and Down [▲]/[▼] buttons to select an option, and then press [ENTER].

The options are:

**Save:**

Save the calculated settings and exit the automatic speaker setup.

**Review SP Config:**

Review the speaker configuration settings (see “Reviewing the Results” on page 58).

**Review SP Distance:**

Review the speaker distance settings (see “Reviewing the Results” on page 58).

**Review SP Level:**

Review the speaker level settings (see “Reviewing the Results” on page 58).

**Cancel:**

Cancel the automatic speaker setup.

### 10

If you selected “Save,” the results are saved, and the following screen appears.

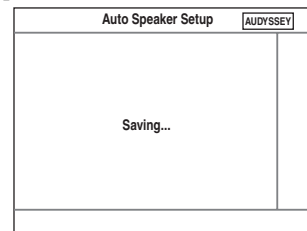

### 11

Disconnect the speaker setup microphone.

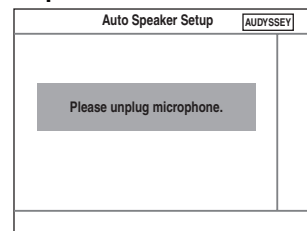

**Notes:**

- When the automatic speaker setup is complete, the Equalizer Settings (page 82) will be set to “Audyssey.”
- You can cancel the automatic speaker setup at any point in this procedure simply by disconnecting the setup microphone.

## First Time Setup—Continued

### Error Messages

While the automatic speaker setup is in progress, one of the following error messages may appear:

#### ❑ Ambient noise is too high.

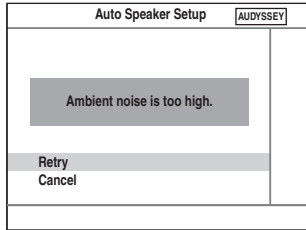

This message appears if the background noise is too loud and the measurements cannot be performed properly.

Remove the source of the noise and try again.

**Retry:** Return to the measured point immediately before and start set up again.

**Cancel:** Cancel the automatic speaker setup.

#### ❑ Speaker Detect Error

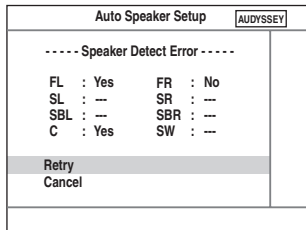

One of the front speakers has not been detected.

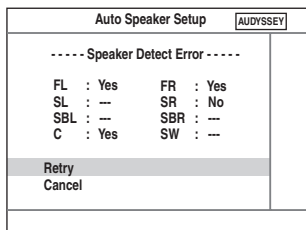

One of the surround speakers has not been detected.

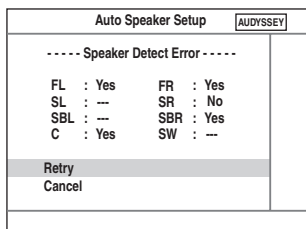

The surround back speakers have been detected but the surround speakers haven't.

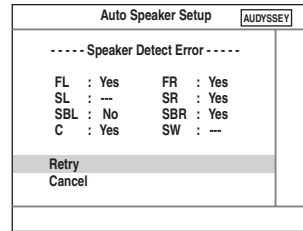

The right surround back speaker has been detected but the left surround back speaker hasn't.

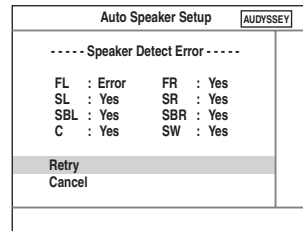

There is a problem with a speaker. The speaker may be broken or the subwoofer may be emitting sound that is too high.

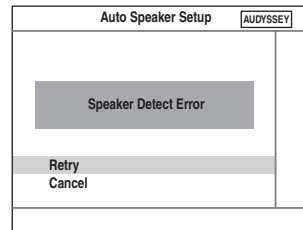

The number of speakers detected on the second or third measurement was different to the number detected on the first measurement.

Make sure speakers that cannot be detected are connected properly.

**Retry:** Return to step 2 and try again.

**Cancel:** Cancel the automatic speaker setup.

#### ❑ Writing Error!

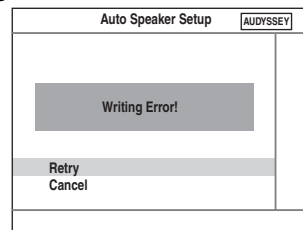

This message appears if saving fails.

Try saving again. If this message appears after 2 or 3 attempts, the AV receiver/AV amplifier is probably malfunctioning. Contact your Onkyo dealer.

**Retry:** Return to step 2 and try again.

**Cancel:** Cancel the automatic speaker setup.

## First Time Setup—Continued

### Reviewing the Results



Use the Up and Down [▲]/[▼] buttons to select the settings that you want to review, and then press [ENTER].

Auto Speaker Setup		AUDYSSEY
Save		
Review SP Config		
Review SP Distance		
Review SP Level		
Cancel		

The options are:

#### Review SP Config:

Review the speaker configuration settings.

Auto Speaker Setup		AUDYSSEY
Review SP Config		
Subwoofer	:	Yes
Front	:	Full Band
Center	:	80Hz
Surround	:	100Hz
Surr Back	:	150Hz
Surr Back Ch	:	2ch

#### Review SP Distance:

Review the speaker distance settings.

Auto Speaker Setup		AUDYSSEY
Review SP Distance		
Left	:	15.0ft
Center	:	15.0ft
Right	:	15.0ft
Surr Right	:	7.0ft
Surr Back R	:	7.0ft
Surr Back L	:	7.0ft
Surr Left	:	7.0ft
Subwoofer	:	15.0ft

#### Review SP Level:

Review the speaker level settings.

Auto Speaker Setup		AUDYSSEY
Review SP Level		
Left	:	+12.0dB
Center	:	0.0dB
Right	:	-12.0dB
Surr Right	:	+3.0dB
Surr Back R	:	+4.0dB
Surr Back L	:	-6.0dB
Surr Left	:	-3.0dB
Subwoofer	:	0.0dB

Press the [RETURN] button to return to the previous menu.

### Changing the Speaker Settings Manually

In some situations, the measurements taken by the automatic speaker setup may not provide usable results. If running the speaker setup a second time still doesn't provide usable results, you'll have to set the speaker settings manually (see pages 77–83).

#### Notes:

- Please note that any THX main speakers should be set to Small [80 Hz (THX)]. If you set up your speakers using the Automatic Speaker Setup function, please make sure manually that any THX speakers are set to Small with 80 Hz (THX) crossover (see page 77).
- Sometimes due to the electrical complexities of subwoofers and the interaction with the room, THX recommends setting the level and the distance of the subwoofer manually.
- Sometimes due to interaction with the room, you may notice irregular results when setting the level and/or distance of the main speakers. If this happens, THX recommends setting them manually.

### Using a Powered Subwoofer

If you're using a powered subwoofer, because it outputs very low-frequency sound and its position is usually low, it may not be detected by the automatic speaker setup. If the subwoofer (SW) appears on the SP Detect Result screen as "No," increase the subwoofer's volume to the half-way point, set it to its highest crossover frequency, and then try running the automatic speaker setup again. Note that if the volume is set too high and the sound distorts, it may not be detected, so use an appropriate volume level. If the subwoofer has a low-pass filter switch, set it to Off or Direct. Refer to your subwoofer's instruction manual for details.

# Basic Operations

## Selecting the Input Source

This section explains how to select the input source (i.e., the AV component that you want to listen to or watch).

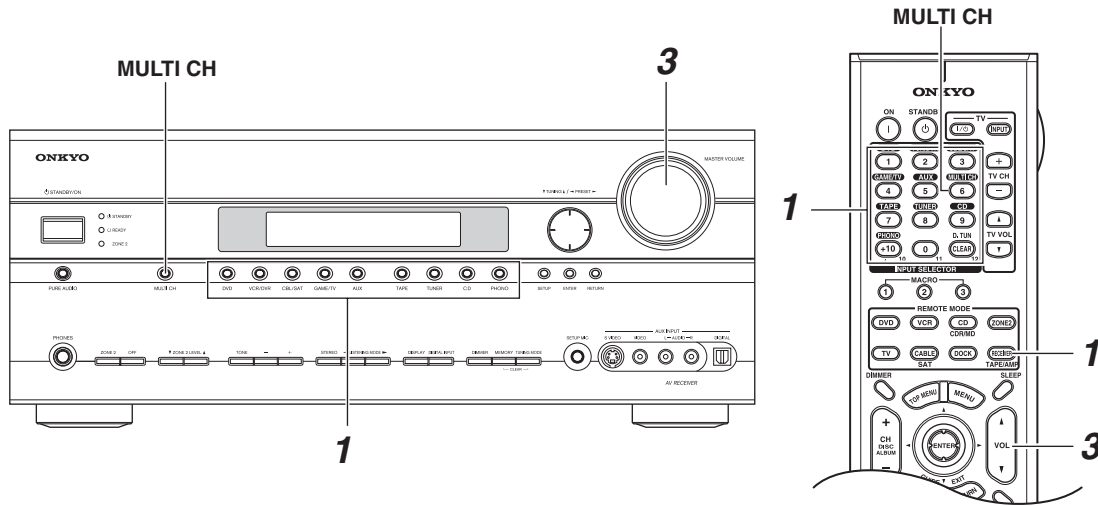

- 1 AV receiver/ AV amplifier**

Use the AV receiver/AV amplifier's input selector buttons to select the input source.

**Remote controller**

To select the input source with the remote controller, press the [RECEIVER] button, and then use the INPUT SELECTOR buttons.
- 2**

**Start playback on the source component.**

When you select DVD or another video component, on your TV, you'll need to select the video input that's connected to the AV receiver/AV amplifier's COMPONENT VIDEO OUT, HDMI OUT or MONITOR OUT. On some DVD players, you may need to turn on the digital audio output.
- 3 AV receiver/ AV amplifier**

**Remote controller**

**To adjust the volume, use the MASTER VOLUME control, or the remote controller's [VOL.] button.**

The volume can be set to  $-\infty$  dB,  $-81$  dB through  $+17$ ,  $+18$  dB. The AV receiver/AV amplifier is designed for home theater enjoyment. It has a wide volume range, allowing precise adjustment.
- 4**

**Select a listening mode and enjoy!**

See "Using the Listening Modes" on page 66.

## Basic Operations—Continued

### Using the Multichannel DVD Input

The multichannel DVD input is for connecting a component with a 7.1-channel analog audio output, such as a DVD-Audio or SACD-capable DVD player, or an MPEG decoder. See page 31 for hookup information.

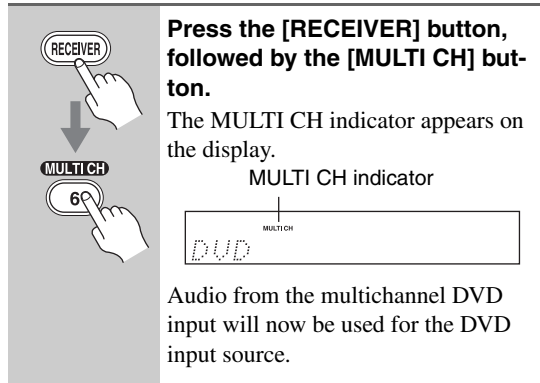

**Press the [RECEIVER] button, followed by the [MULTI CH] button.**

The MULTI CH indicator appears on the display.

MULTI CH indicator

Audio from the multichannel DVD input will now be used for the DVD input source.

#### Note:

While the multichannel DVD input is selected, the Speaker Configuration settings on page 77 are ignored, and signals from the multichannel input are fed to the speakers as they are.

### Adjusting the Bass & Treble

You can adjust the bass and treble for the front speakers, except when the Direct or Pure Audio listening mode is selected.

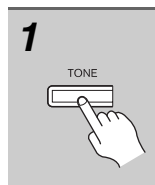

**1** Press the [TONE] button repeatedly to select either Bass or Treble.

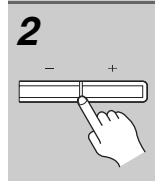

**2** Use the TONE [-]/[+] buttons to adjust.

#### ■ Bass

You can boost or cut low-frequency sounds output by the front speakers from -10 dB to +10 dB in 2 dB steps.

#### ■ Treble

You can boost or cut high-frequency sounds output by the front speakers from -10 dB to +10 dB in 2 dB steps.

#### Note:

The Bass & Treble settings do not apply to the THX listening modes.

### Displaying Source Information

You can display various information about the current input source as follows.

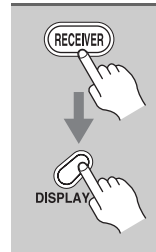

**Press the [RECEIVER] button, and then press the [DISPLAY] button repeatedly to cycle through the available information.**

#### Note:

This procedure can also be performed on the AV receiver/AV amplifier by using its [DISPLAY] button.

The following information can typically be displayed for input sources.

Input source & volume	DVD	48
Signal format* or sampling frequency	Dolby D	5.1
Input source & listening mode	DVD	Dolby D

\* If the input signal is analog, no format information is displayed. If the input signal is PCM, the sampling frequency is displayed. If the input signal is digital but not PCM, the signal format is displayed. Information is displayed for about three seconds, then the previously displayed information reappears.

## Basic Operations—Continued

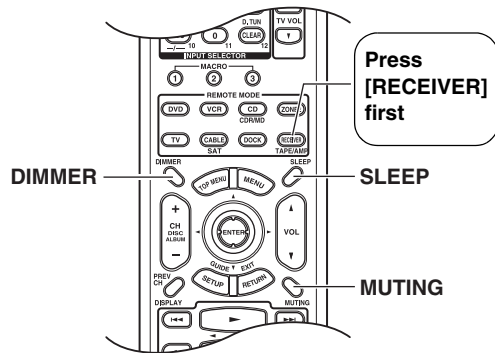

### Setting the Display Brightness

You can adjust the brightness of the display.

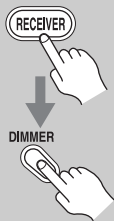

Press the [RECEIVER] button, and then press the [DIMMER] button repeatedly to select:

- Normal + VOLUME light on.
- Normal + VOLUME light off.
- Dim + VOLUME light off.
- Dimmer + VOLUME light off.

Alternatively, you can use the AV receiver/AV amplifier's [DIMMER] button (not European models).

### Muting the AV receiver/AV amplifier

You can temporarily mute the output of the AV receiver/AV amplifier.



Press the [RECEIVER] button, and then press the [MUTING] button.

The output is muted and the MUTING indicator flashes on the display, as shown.



To unmute the AV receiver/AV amplifier, press the [MUTING] button again, or adjust the volume.

The Mute function is cancelled when the AV receiver/AV amplifier is set to Standby.

#### Tip:

You can specify how much the output is muted with the Muting Level setting (see page 92).

### Using the Sleep Timer

With the sleep timer, you can set the AV receiver/AV amplifier to turn off automatically after a specified period.



Press the [RECEIVER] button, and then press the [SLEEP] button repeatedly to select the required sleep time.

The sleep time can be set from 90 to 10 minutes in 10 minute steps.

The SLEEP indicator appears on the display when the sleep timer has been set. The specified sleep time appears on the display for about five seconds, then the previous display reappears.

If you need to cancel the sleep timer, press the [SLEEP] button repeatedly until the SLEEP indicator disappears.

To check the time remaining until the AV receiver/AV amplifier sleeps, press the [SLEEP] button. Note that if you press the [SLEEP] button while the sleep time is being displayed, you'll shorten the sleep time by 10 minutes.

### Using Headphones

You can connect a pair of stereo headphones (1/4-inch phone plug) to the AV receiver/AV amplifier's PHONES jack for private listening, as shown.

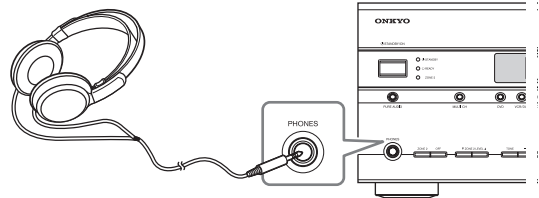

#### Notes:

- Always turn down the volume before connecting your headphones.
- The speakers are turned off while the headphones plug is inserted in the PHONES jack (Zone 2 speakers are not turned off).
- When you connect a pair of headphones, the listening mode is set to Stereo, unless it's already set to Stereo, Mono, Direct, or Pure Audio.
- Only the Stereo, Direct, Pure Audio, and Mono listening modes can be used with headphones (the listening modes available also depend on the currently selected input source).
- When the multichannel input is used, only the front left and right audio can be heard in the headphones.
- To adjust the headphone level, press the [CH SEL] button on the remote controller, and then press the [LEVEL +]/[LEVEL -] buttons. You can adjust the level between -12 dB and +12 dB.

# Listening to the Radio (TX-SR705 only)

## Using the Tuner

With the built-in tuner you can enjoy AM and FM radio stations. You can store your favorite stations as presets for quick selection.

### Listening to the Radio



**Use the [TUNER] input selector button to select either AM or FM.**  
In this example, FM has been selected. Each time you press the [TUNER] button, the input source changes between AM and FM.

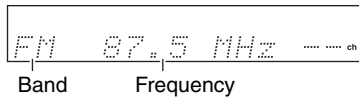

(Actual display depends on country)

### Tuning into Radio Stations

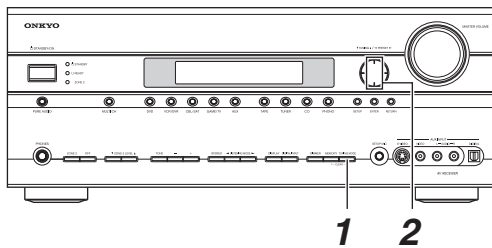

## Auto Tuning Mode

- 1** Press the [TUNING MODE] button so that the **AUTO** indicator appears on the display.
- 2** Press the TUNING Up or Down [▲]/[▼] buttons. Searching stops when a station is found.

When tuned into a station, the TUNED indicator appears. When tuned into a stereo FM station, the FM STEREO indicator appears on the display, as shown.



## Manual Tuning Mode

- 1** Press the [TUNING MODE] button so that the **AUTO** indicator disappears from the display.
- 2** Press and hold the TUNING Up or Down [▲]/[▼] buttons. The frequency stops changing when you release the button. Press the buttons repeatedly to change the frequency one step at a time.

The North American models change FM frequency in 0.2 MHz steps, 10 kHz steps for AM. For other models it's 0.05 MHz steps for FM and 9 kHz steps for AM. In Manual Tuning mode, FM stations will be in mono.

### Tuning into weak FM stereo stations

If the signal from a stereo FM station is weak, it may be impossible to get good reception. In this case, switch to Manual Tuning mode and listen to the station in mono.

## Tuning into Stations by Frequency

You can tune into AM and FM stations directly by entering the appropriate frequency.

- 1** Press the [RECEIVER] button, followed by the [D. TUN] button. The [RECEIVER] button flashes.

(Actual display depends on country.)
- 2** Within 8 seconds, use the number buttons to enter the frequency of the radio station. For example, to tune to 87.5 (FM), press 8, 7, 5. **Note:** While the [RECEIVER] button is flashing, the input source cannot be changed by using the remote controller.

## Listening to the Radio (TX-SR705 only)—Continued

### Presetting AM/FM Stations

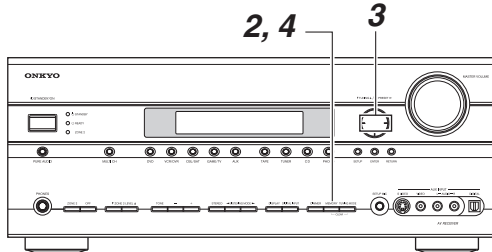

You can store a combination of up to 40 of your favorite AM/FM radio stations as presets.

- |          |   |
|----------|---|
| <b>1</b> | <b>Tune into the AM/FM station that you want to store as a preset.</b>  |
| <b>2</b> | <b>Press the [MEMORY] button.</b><br>The preset number flashes.   |
| <b>3</b> | <b>While the preset number is flashing (about 8 seconds), use the PRESET [◀]/[▶] buttons to select a preset from 1 through 40.</b>  |
| <b>4</b> | <b>Press the [MEMORY] button again to store the station or channel.</b><br>The station or channel is stored and the preset number stops flashing.<br>Repeat this procedure for all of your favorite AM/FM radio stations. |

### Selecting Presets

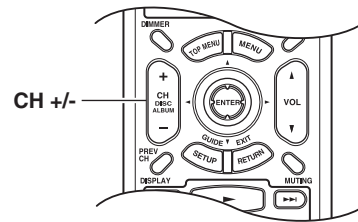
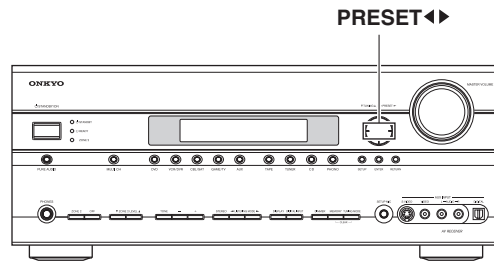

- |          |  |
|----------|--|
| <b>1</b> | <b>To select a preset, use the PRESET [◀]/[▶] buttons, or the remote controller's CH [+/-] button.</b> |
|----------|--|

### Deleting Presets

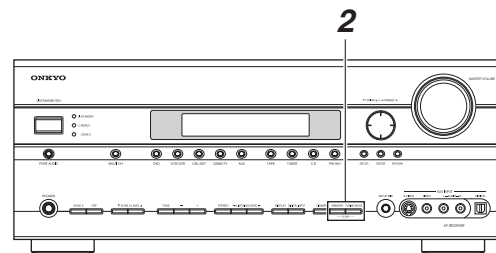

- |          |   |
|----------|---|
| <b>1</b> | <b>Select the preset that you want to delete.</b><br>See the previous section.  |
| <b>2</b> | <b>While holding down the [MEMORY] button, press the [TUNING MODE] button.</b><br>The preset is deleted and its number disappears from the display. |

## Listening to the Radio (TX-SR705 only)—Continued

### Using RDS (European models only)

RDS only works with European models and only in areas where RDS broadcasts are available.

When tuned into an RDS station, the RDS indicator appears.

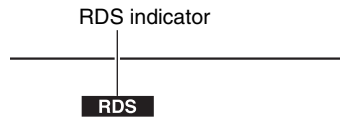

#### ■ What is RDS?

RDS stands for *Radio Data System* and is a method of transmitting data in FM radio signals. It was developed by the European Broadcasting Union (EBU) and is available in most European countries. Many FM stations use it these days. In addition to displaying text information, RDS can also help you find radio stations by type (e.g., news, sport, rock, etc.).

The AV receiver supports four types of RDS information:

#### **PS (Program Service)**

When tuned to an RDS station that's broadcasting PS information, the station's name will be displayed. Pressing the [DISPLAY] button will display the frequency for 3 seconds.

#### **RT (Radio Text)**

When tuned to an RDS station that's broadcasting text information, the text will be shown on the display (see page 65).

#### **PTY (Program Type)**

This allows you to search for RDS radio stations by type (see page 65).

#### **TP (Traffic Program)**

This allows you to search for RDS radio stations that broadcast traffic information (see page 65).

#### **Notes:**

- In some cases, the text characters displayed on the AV receiver may not be identical to those broadcast by the radio station. Also, unexpected characters may be displayed when unsupported characters are received. This is not a malfunction.
- If the signal from an RDS station is weak, RDS data may be displayed intermittently or not at all.

### RDS Program Types (PTY)

Type	Display
None	NONE
News reports	NEWS
Current affairs	AFFAIRS
Information	INFO
Sport	SPORT
Education	EDUCATE
Drama	DRAMA
Culture	CULTURE
Science and technology	SCIENCE
Varied	VARIED
Pop music	POP M
Rock music	ROCK M
Middle of the road music	EASY M
Light classics	LIGHT M
Serious classics	CLASSICS
Other music	OTHER M
Weather	WEATHER
Finance	FINANCE
Children's programmes	CHILDREN
Social affairs	SOCIAL
Religion	RELIGION
Phone in	PHONE IN
Travel	TRAVEL
Leisure	LEISURE
Jazz music	JAZZ
Country music	COUNTRY
National music	NATION M
Oldies music	OLDIES
Folk music	FOLK M
Documentary	DOCUMENT
Alarm test	TEST
Alarm	ALARM

## Listening to the Radio (TX-SR705 only)—Continued

### Displaying Radio Text (RT)

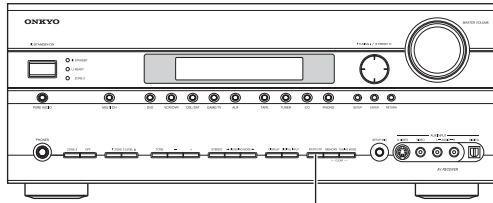

RT/PTY/TP

When tuned to an RDS station that's broadcasting text information, the text can be displayed.

**Press the [RT/PTY/TP] button once.**  
The RT information scrolls across the display.

**Notes:**

- The message "Waiting" may appear while the AV receiver waits for the RT information.
- If the message "No Text Data" appears on the display, no RT information is available.

### Finding Stations by Type (PTY)

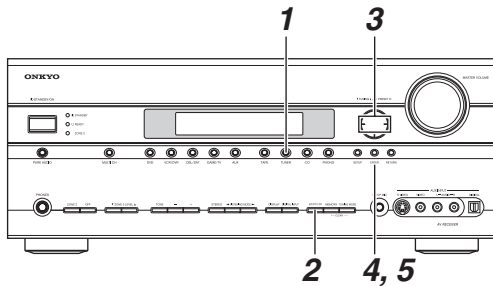

You can search for radio stations by type.

- 1 Use the [TUNER] input selector button to select FM.**
- 2 Press the [RT/PTY/TP] button twice.**  
The current program type appears on the display.
- 3 Use the PRESET [◀]/[▶] buttons to select the type of program you want.**  
See the table on page 64.

- 4 To start the search, press [ENTER].**  
The AV receiver searches until it finds a station of the type you specified, at which point it stops briefly before continuing with the search.
- 5 When a station you want to listen to is found, press [ENTER].**  
If no stations are found, the message "Not Found" appears.

### Listening to Traffic News (TP)

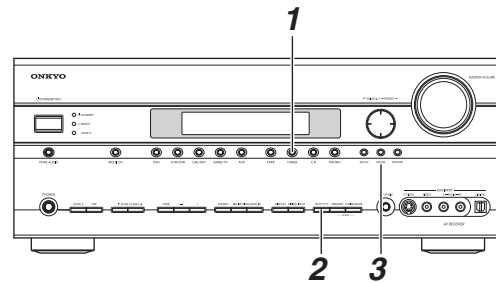

You can search for stations that broadcast traffic news.

- 1 Use the [TUNER] input selector button to select FM.**
- 2 Press the [RT/PTY/TP] button three times.**  
If the current radio station is broadcasting TP (Traffic Program), "[TP]" will appear on the display, and traffic news will be heard as and when it's broadcast. If "TP" without square brackets appears, this means that the station is not broadcasting TP.
- 3 To locate a station that is broadcasting TP, press [ENTER].**  
The AV receiver searches until it finds a station that's broadcasting TP. If no stations are found, the message "Not Found" appears.

# Using the Listening Modes

## Selecting Listening Modes

See “About the Listening Modes” on page 71 for detailed information about the listening modes.

- The Dolby Digital and DTS listening modes can only be selected if your DVD player is connected to the AV receiver/AV amplifier with a digital audio connection (coaxial or optical).
- Listening mode availability depends on the format of the current input signal.

## Selecting on the AV receiver/AV amplifier

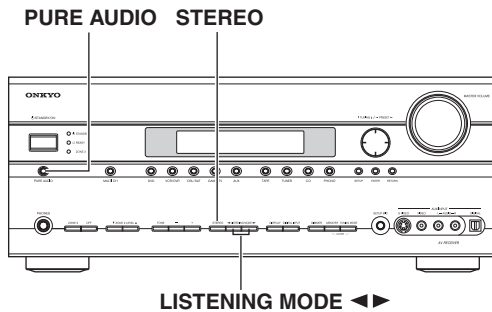

- **[PURE AUDIO] button**  
This button selects the Pure Audio listening mode. When this mode is selected, the AV receiver/AV amplifier's display is turned off and only video signals input through HDMI IN can be output. Pressing this button again will select the previous listening mode.
- **[STEREO] button**  
This button selects the Stereo listening mode.
- **LISTENING MODE [◀/▶] buttons**  
Pressing these buttons repeatedly cycles through all of the listening modes that can be used with the current input source.

## Selecting with the Remote Controller

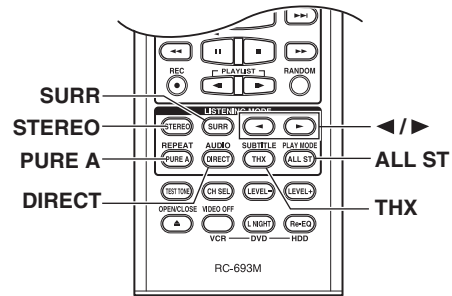

- **[STEREO] button**  
This button selects the Stereo listening mode.
- **[SURR] button**  
This button selects the Dolby Digital and DTS listening modes and the Neural THX Surround listening mode.
- **LISTENING MODE [◀/▶] buttons**  
Pressing these buttons repeatedly cycles through all of the listening modes that can be used with the current input source.
- **[PURE A] button**  
This button selects the Pure Audio listening mode. When this mode is selected, the AV receiver's display is turned off and only the HDMI OUT outputs video signals.
- **[DIRECT] button**  
This button selects the Direct listening mode.
- **[THX] button**  
This button selects the THX listening modes.
- **[ALL ST] button**  
This button selects the All Channel Stereo listening mode.

## Using the Listening Modes—Continued

### Listening Modes Available for Each Source Format

#### Analog and PCM Sources

Button	Source format Media Listening Mode	PCM		Multi channel analog	Multichannel PCM						
		32–96 kHz	176.4/192kHz*1		32–96 kHz			176.4/192 kHz*1			
					except *2	*2	2ch	1/0, 1+1	Multichannel	2ch	
[PURE A]	Pure Audio	✓	✓	✓	✓	✓	✓	✓	✓	✓	✓
[DIRECT]	Direct	✓	✓	✓	✓	✓	✓	✓	✓	✓	✓
[STEREO]	Stereo	✓	✓		✓	✓	✓	✓	✓	✓	✓
[SURR]	Multichannel			✓	✓	✓			✓		
	Dolby D										
	Dolby D Plus										
	DTS, DTS 96/24										
	DTS-ES Discrete/Matrix										
	DTS-HD High Resolution										
	DTS-HD Master Audio										
	Dolby TrueHD										
	DSD										
	Dolby PLII Movie/ Dolby PLIIx Movie*2	✓					✓	✓			
	Dolby PLII Music/ Dolby PLIIx Music*2	✓					✓	✓			
	Dolby PLII Game/ Dolby PLIIx Game*2	✓						✓			
	Dolby Digital EX/Dolby EX						✓				
	Neo:6						✓				
	Neo:6 Cinema	✓						✓			
Neo:6 Music	✓						✓				
Neural THX 5.1	✓						✓				
Neural THX 7.1	✓						✓	✓			
[THX]	THX Cinema*3				✓	✓					
	Dolby PLII/ Dolby PLIIx THX*3	✓*2				✓	✓				
	Neo:6 THX*3	✓*3				✓	✓				
	Dolby PLII THX Games Mode	✓					✓				
	Neo:6 THX Games Mode	✓					✓				
	THX Surround EX						✓				
	THX Select2 Cinema						✓				
	THX Music Mode						✓				
	THX Games Mode						✓				
LISTENING MODE*4 [◀]/[▶]	Mono	✓			✓	✓	✓	✓			
	Onkyo Original DSP Mono Movie Orchestra Unplugged Studio-Mix TV Logic All Ch Stereo Full Mono T-D	✓			✓	✓	✓	✓			

\*1. DVD-Audio discs output multichannel 176.4/192 kHz PCM only via HDMI.

\*2. If there are no surround back speakers, or Powered Zone 2 is being used, Dolby Pro Logic II is used.

\*3. Available only when using surround speakers.

\*4. For T-D, Mono Movie, Orchestra, Unplugged, Studio-Mix, and TV Logic, PCM of 64 kHz, 88.2 kHz, and 96 kHz are processed at 32 kHz, 44.1 kHz, and 48 kHz respectively.

Requires 6.1/7.1 speakers. Not available while Powered Zone 2 is being used.

Requires 7.1 speakers. Not available while Powered Zone 2 is being used.

## Using the Listening Modes—Continued

### DSD, Dolby Digital, and Dolby Digital Plus Sources

Button	Listening Mode	DSD <sup>*1</sup>		Dolby D				Dolby Digital Plus			
		Multichannel		Multichannel		2ch	1/0, 1+1	Multichannel		2ch	1/0, 1+1
		3/2	2ch	except *1/2	*1/2			except *1/2	*1/2		
Media		SACD		DVD, DTV, etc.				Blu-ray, HD DVD			
[PURE A]	Pure Audio	✓	✓	✓	✓	✓	✓	✓	✓	✓	✓
[DIRECT]	Direct	✓	✓	✓	✓	✓	✓	✓	✓	✓	✓
[STEREO]	Stereo	✓	✓	✓	✓	✓	✓	✓	✓	✓	✓
[SURR]	Multichannel										
	Dolby D			✓	✓						
	Dolby D Plus							✓ <sup>*2</sup>	✓ <sup>*2</sup>		
	DTS, DTS 96/24										
	DTS-ES Discrete/Matrix										
	DTS-HD High Resolution										
	DTS-HD Master Audio										
	Dolby TrueHD										
	DSD	✓									
	Dolby PLII Movie/ Dolby PLIIx Movie <sup>*3</sup>					✓	✓			✓	✓
	Dolby PLII Music/ Dolby PLIIx Music <sup>*3</sup>					✓	✓			✓	✓
	Dolby PLII Game/ Dolby PLIIx Game <sup>*3</sup>						✓				✓
	Dolby Digital EX/Dolby EX					✓				✓	
	Neo:6					✓				✓	
	Neo:6 Cinema						✓				✓
Neo:6 Music						✓				✓	
Neural THX 5.1						✓				✓	
Neural THX 7.1						✓			✓	✓	
[THX]	THX Cinema <sup>*4</sup>			✓	✓			✓	✓		
	Dolby PLII/ Dolby PLIIx THX				✓	✓			✓	✓	
	Neo:6 THX				✓	✓			✓	✓	
	Dolby PLII THX Games Mode					✓				✓	
	Neo:6 THX Games Mode					✓				✓	
	THX Surround EX				✓				✓		
	THX Select2 Cinema				✓				✓		
	THX Music Mode				✓				✓		
THX Games Mode				✓				✓			
LISTENING MODE [◀]/[▶]	Mono			✓	✓	✓	✓	✓	✓	✓	✓
	Onkyo Original DSP										
	Mono Movie Orchestra Unplugged Studio-Mix TV Logic All Ch Stereo Full Mono T-D			✓	✓	✓	✓	✓	✓	✓	✓

\*1. DSD sources are converted and handled as PCM.

\*2. If there are no surround back speakers, depending on the input signal, Dolby Digital may be used.

\*3. If there are no surround back speakers, or Powered Zone 2 is being used, Dolby Pro Logic II is used.

\*4. Available only when using surround speakers.

Requires 6.1/7.1 speakers. Not available while Powered Zone 2 is being used.

Requires 7.1 speakers. Not available while Powered Zone 2 is being used.

## Using the Listening Modes—Continued

### TrueHD and DTS Sources

Button	Source format	TrueHD <sup>*1</sup>				DTS, DTS96/24				DTS-ES Discrete/Matrix
		Multichannel		2ch	1/0, 1+1	Multichannel		2ch	1/0	
		except *1/2	*1/2			except *1/2	*1/2			
Listening Mode	Media	Blu-ray, HD DVD				DVD, CD, etc.				
[PURE A]	Pure Audio	✓	✓	✓	✓	✓	✓	✓	✓	✓
[DIRECT]	Direct	✓	✓	✓	✓	✓	✓	✓	✓	✓
[STEREO]	Stereo	✓	✓	✓	✓	✓	✓	✓	✓	✓
[SURR]	Multichannel									
	Dolby D									
	Dolby D Plus									
	DTS, DTS 96/24					✓	✓			
	DTS-ES Discrete/Matrix									✓ <sup>*2</sup>
	DTS-HD High Resolution									
	DTS-HD Master Audio									
	TrueHD		✓	✓						
	DSD									
	Dolby PLII Movie/ Dolby PLIIx Movie <sup>*3</sup>			✓	✓			✓	✓	
	Dolby PLII Music/ Dolby PLIIx Music <sup>*3</sup>			✓	✓			✓	✓	
	Dolby PLII Game/ Dolby PLIIx Game <sup>*3</sup>				✓				✓	
	Dolby Digital EX/Dolby EX			✓				✓		
	Neo:6			✓				✓		
	Neo:6 Cinema				✓				✓	
	Neo:6 Music				✓				✓	
	Neural THX 5.1				✓				✓	
Neural THX 7.1			✓	✓			✓	✓	✓	
[THX]	THX Cinema <sup>*4</sup>	✓	✓			✓	✓			✓
	Dolby PLII/ Dolby PLIIx THX		✓	✓			✓	✓		
	Neo:6 THX		✓	✓			✓	✓		
	Dolby PLII THX Games Mode			✓				✓		
	Neo:6 THX Games Mode			✓				✓		
	THX Surround EX		✓				✓			
	THX Select2 Cinema		✓				✓			✓
	THX Music Mode		✓				✓			✓
	THX Games Mode		✓				✓			✓
LISTENING MODE <sup>*5</sup> [◀/▶]	Mono					✓	✓	✓	✓	✓
	Onkyo Original DSP Mono Movie Orchestra Unplugged Studio-Mix TV Logic All Ch Stereo Full Mono T-D	✓	✓	✓	✓	✓	✓	✓	✓	✓

\*1. For 96 kHz TrueHD sources, only the Tone audio adjust function is available. 192 kHz TrueHD sources are not supported.

\*2. If there are no surround back speakers, or Powered Zone 2 is being used, DTS is used.

\*3. If there are no surround back speakers, or Powered Zone 2 is being used, Dolby Pro Logic II is used.

\*4. Available only when using surround speakers.

\*5. For T-D, Mono Movie, Orchestra, Unplugged, Studio-Mix, and TV Logic, DTS 96/24 is processed as DTS.

Requires 6.1/7.1 speakers. Not available while Powered Zone 2 is being used.

Requires 7.1 speakers. Not available while Powered Zone 2 is being used.

## Using the Listening Modes—Continued

### DTS-HD Sources

Button	Source format	DTS-HD High Resolution				DTS-HD Master Audio <sup>*1</sup>			
		Multichannel		2ch	1/0	Multichannel		2ch	1/0
		except */2	*/2			except */2	*/2		
Listening Mode	Media	Blu-ray, HD DVD				Blu-ray, HD DVD			
[PURE A]	Pure Audio	✓	✓	✓	✓	✓	✓	✓	✓
[DIRECT]	Direct	✓	✓	✓	✓	✓	✓	✓	✓
[STEREO]	Stereo	✓	✓	✓	✓	✓	✓	✓	✓
[SURR]	Multichannel								
	Dolby D								
	Dolby D Plus								
	DTS, DTS 96/24								
	DTS-ES Discrete/Matrix								
	DTS-HD High Resolution	✓	✓						
	DTS-HD Master Audio					✓	✓		
	TrueHD								
	DSD								
	Dolby PLII Movie/ Dolby PLIIx Movie <sup>*2</sup>			✓ <sup>*3</sup>	✓ <sup>*3</sup>			✓	✓
	Dolby PLII Music/ Dolby PLIIx Music <sup>*2</sup>			✓ <sup>*3</sup>	✓ <sup>*3</sup>			✓	✓
	Dolby PLII Game/ Dolby PLIIx Game <sup>*2</sup>				✓ <sup>*3</sup>				✓
	Dolby Digital EX/Dolby EX			✓ <sup>*3</sup>				✓	
	Neo:6			✓ <sup>*3</sup>				✓	
	Neo:6 Cinema				✓ <sup>*3</sup>				✓
Neo:6 Music				✓ <sup>*3</sup>				✓	
Neural THX 5.1				✓				✓	
Neural THX 7.1			✓	✓			✓	✓	
[THX]	THX Cinema <sup>*2</sup>	✓	✓			✓	✓		
	Dolby PLII/ Dolby PLIIx THX			✓	✓			✓	✓
	Neo:6 THX			✓	✓			✓	✓
	Dolby PLII THX Games Mode				✓				✓
	Neo:6 THX Games Mode				✓				✓
	THX Surround EX			✓				✓	
	THX Select2 Cinema			✓				✓	
	THX Music Mode			✓				✓	
	THX Games Mode			✓				✓	
LISTENING MODE [<]/[>]	Mono	✓ <sup>*3</sup>	✓ <sup>*3</sup>	✓ <sup>*3</sup>	✓ <sup>*3</sup>	✓	✓	✓	✓
	Onkyo Original DSP Mono Movie Orchestra Unplugged Studio-Mix TV Logic All Ch Stereo Full Mono T-D <sup>*4</sup>	✓	✓	✓	✓	✓	✓	✓	✓

\*1. For 96 kHz DTS-HD Master Audio sources, only the Tone audio adjust function is available. 192 kHz DTS-HD Master Audio sources are processed at 96 kHz.

\*2. If there are no surround back speakers, or Powered Zone 2 is being used, Dolby Pro Logic II is used.

\*3. Depending on the source (e.g., 96 kHz sources), processing may be performed after DTS decoding.

\*4. Available only when using surround speakers.

Requires 6.1/7.1 speakers. Not available while Powered Zone 2 is being used.

Requires 7.1 speakers. Not available while Powered Zone 2 is being used.

## Using the Listening Modes—Continued

### About the Listening Modes

The AV receiver/AV amplifier's listening modes can transform your listening room into a movie theater or concert hall, with high fidelity and stunning surround sound.

#### Pure Audio

In this mode, the display and video circuitry are turned off, minimizing possible noise sources for the ultimate in high-fidelity reproduction. (As the video circuitry is turned off, only video signals input through HDMI IN can be output.)

#### Direct

In this mode, audio from the input source is output directly with minimal processing, providing high-fidelity reproduction. All of the source's audio channels are output as they are.

#### Stereo

Sound is output by the front left and right speakers and subwoofer.

#### Mono

Use this mode when watching an old movie with a mono soundtrack, or use it with the foreign language soundtracks recorded in the left and right channels of some movies. It can also be used with DVDs or other sources containing multiplexed audio, such as karaoke DVDs.

#### Dolby Pro Logic IIx

##### Dolby Pro Logic II

**Dolby Pro Logic IIx** expands any 2-channel source for 7.1-channel playback. It provides a very natural and seamless surround-sound experience that fully envelops the listener. As well as music and movies, video games can also benefit from the dramatic spatial effects and vivid imaging. If you're not using any surround back speakers, **Dolby Pro Logic II** will be used instead of Dolby Pro Logic IIx.

- **Dolby PLIIx Movie**  
Use this mode with any stereo or Dolby Surround (Pro Logic) movie (e.g., TV, DVD, VHS).
- **Dolby PLIIx Music**  
Use this mode with any stereo or Dolby Surround (Pro Logic) music source (e.g., CD, radio, cassette, TV, VHS, DVD).
- **Dolby PLIIx Game**  
Use this mode with video games, especially those that bear the Dolby Pro Logic II logo.

#### Dolby Digital

Use this mode with DVDs that bear the Dolby Digital logo, and Dolby Digital TV broadcasts. This is the most common digital surround-sound format, and it'll put you right in the middle of the action, just like being in a movie theater or concert hall.

##### 5.1-channel source + Dolby EX

These modes expand 5.1-channel sources for 6.1/7.1-channel playback. They're especially suited to Dolby EX soundtracks that include a matrix-encoded surround back channel. The additional channel adds an extra dimension and provides an enveloping surround sound experience, perfect for rotating and fly-by sound effects.

#### Dolby Digital Plus

Developed for use with HDTV, including the new video disc formats Blu-ray and HD DVD, this is the latest multichannel audio format from Dolby. It supports up to 7.1 channels with 48 kHz sampling rate.

#### Dolby TrueHD

Designed to take full advantage of the additional storage space offered by the new Blu-ray and HD DVD disc formats, this new Dolby format offers up to 7.1 discrete channels of digital audio with 48/96 kHz, up to 5.1-channels with 192 kHz sampling rate.

For the signals supported by the AV receiver/AV amplifier, see page 69.

##### 5.1-channel source + Dolby PLIIx Music

These modes use the Dolby Pro Logic IIx Music mode to expand 5.1-channel sources for 6.1/7.1-channel playback.

##### 5.1-channel source + Dolby PLIIx Movie

These modes use the Dolby Pro Logic IIx Movie mode to expand 5.1-channel sources for 7.1-channel playback.

#### DTS

The DTS digital surround-sound format supports up to 5.1 discrete channels and uses less compression for high-fidelity reproduction. Use it with DVDs and CDs that bear the DTS logo.

##### DTS 96/24

This mode is for use with DTS 96/24 sources. This is high-resolution DTS with a 96 kHz sampling rate and 24-bit resolution, providing superior fidelity. Use it with DVDs that bear the DTS 96/24 logo.

##### DTS-ES Discrete

This mode is for use with DTS-ES Discrete soundtracks, which use a discrete surround back channel for true 6.1/7.1-channel playback. The seven totally separate audio channels provide better spatial imaging and 360-degree sound localization, perfect for sounds that pan across the surround channels. Use it with DVDs that bear the DTS-ES logo, especially those with a DTS-ES Discrete soundtrack.

##### DTS-ES Matrix

This mode is for use with DTS-ES Matrix soundtracks, which use a matrix-encoded back-channel for 6.1/7.1-channel playback. Use it with DVDs that bear the DTS-ES logo, especially those with a DTS-ES Matrix soundtrack.

##### DTS Neo:6

This mode expands any 2-channel source for 7.1-channel playback. It uses seven full-bandwidth channels of matrix decoding for matrix-encoded material, providing a very natural and seamless surround sound experience that fully envelops the listener.

- **Neo:6 Cinema**  
Use this mode with any stereo movie (e.g., TV, DVD, VHS).
- **Neo:6 Music**  
Use this mode with any stereo music source (e.g., CD, radio, cassette, TV, VHS, DVD).

## Using the Listening Modes—Continued

### 5.1-channel source + Neo:6

This mode uses Neo:6 to expand 5.1-channel sources for 6.1/7.1-channel playback.

### DTS-HD High Resolution Audio

Developed for use with HDTV, including the new video disc formats Blu-ray and HD DVD, this is the latest multichannel audio format from DTS. It supports up to 7.1 channels with 96 kHz sampling rate.

### DTS-HD Master Audio

Designed to take full advantage of the additional storage space offered by the new Blu-ray and HD DVD disc formats, this new DTS format offers up to 7.1 discrete channels of digital audio with 48/96 kHz, up to 5.1-channels with 192 kHz sampling rate.

For the signals supported by the AV receiver/AV amplifier, see page 70.

### Neural THX 5.1/7.1

Neural-THX Surround employs psychoacoustic frequency domain processing, which allows delivery of a more detailed sound stage, with superior channel separation and localization of audio elements. The Neural THX 5.1 and Neural THX 7.1 modes can expand any 2-channel stereo source for 5.1- or 7.1-channel playback, respectively. Use them with CD, radio, cassette, TV, VHS, DVD, and other 2-channel stereo sources, including video games. Neural-THX Surround can also be used by broadcasters to encode and transmit surround-sound content over a stereo signal, which listeners can enjoy as either surround sound or normal stereo. XM Satellite Radio, for example, is using Neural-THX Surround on select channels, which the AV receiver/AV amplifier can expand from 5.1 channels to 7.1 channels.

### DSD

DSD stands for Direct Stream Digital and is the format used to store digital audio on Super Audio CDs (SACD). This mode can be used with SACDs that feature multichannel audio.

### THX

Founded by George Lucas, THX develops stringent standards that ensure movies are reproduced in movie theaters and home theaters just as the director intended.

- **THX Cinema**

This mode is for watching movies, which are typically recorded and edited on the assumption that they will be played in a sizable place like a movie theater. It carefully optimizes the tonal and spatial characteristics of the soundtrack for reproduction in the smaller home-theater environment. It can be used with 2-channel sources processed with other formats, and multichannel sources. Surround back speaker output depends on the source material and the selected listening mode.

- **THX Select2 Cinema**

This mode expands Dolby Digital and DTS 5.1-channel sources for 7.1-channel playback. It does this by analyzing the composition of the surround source, optimizing the ambient and directional sounds to produce the surround back channel output.

This is a new and improved mode especially for home theater use.

- **THX Music Mode**

This mode is designed for use with music. It expands 5.1-channel sources for 7.1-channel playback.

- **THX Games Mode**

This mode is designed for use with video games. It can expand 2-channel and 5.1-channel sources for 6.1/7.1-channel playback.

- **THX Surround EX**

This mode expands 5.1-channel sources for 6.1/7.1-channel playback. It's especially suited to Dolby Digital EX sources. THX Surround EX, also known as Dolby Digital Surround EX, is a joint development between Dolby Laboratories and THX Ltd.

## Using the Listening Modes—Continued

---

### **Onkyo Original DSP Modes**

---

#### **Mono Movie**

This mode is suitable for old movies and other mono sources. The center speaker outputs the sound as it is, while reverb is applied to the sound output by the other speakers, giving presence to even mono material.

#### **Orchestra**

Suitable for classical or operatic music, this mode emphasizes the surround channels in order to widen the stereo image, and simulates the natural reverberation of a large hall.

#### **Unplugged**

Suitable for acoustic instruments, vocals, and jazz, this mode emphasizes the front stereo image, giving the impression of being right in front of the stage.

#### **Studio-Mix**

Suitable for rock or pop music, listening to music in this mode creates a lively sound field with a powerful acoustic image, like being at a club or rock concert.

#### **TV Logic**

This mode adds realistic acoustics to TV shows produced in a TV studio, surround effects to the entire sound, and clarity to voices.

#### **All Ch Stereo**

Ideal for background music, this mode fills the entire listening area with stereo sound from the front, surround, and surround back speakers.

#### **Full Mono**

In this mode, all speakers output the same sound in mono, so the sound you hear is the same regardless of where you are within the listening room.

#### **T-D (Theater-Dimensional)**

With this mode you can enjoy a virtual 5.1 surround sound even with only two or three speakers. This works by controlling how sounds reach the listener's left and right ears. Good results may not be possible if there's too much reverb, so we recommend that you use this mode in an environment with little or no natural reverb.

# Recording

This section explains how to record the selected input source to a component with recording capability, and how to record audio and video from different sources.

## Notes:

- The surround sound and DSP listening modes cannot be recorded.
- Copy-protected DVDs cannot be recorded.
- You cannot record from the DVD analog multichannel input.
- Various restrictions apply to digital recording. Refer to the manuals supplied with your digital recording equipment for more details.
- Digital input signals are output by only the digital outputs, and analog input signals are output by only the analog outputs. There is no internal conversion from digital to analog or vice versa.
- DTS signals will be recorded as noise, so don't attempt analog recording of DTS CDs or LDs.
- While the listening mode is set to Pure Audio, no image is provided because the power is turned off for the video circuit. If you want to make recordings, select other listening mode.

## AV Recording

Audio sources can be recorded to a recorder (e.g., cassette deck, CDR, MD) connected to the TAPE OUT jack. Video sources can be recorded to a video recorder (e.g., VCR, DVD recorder) connected to the VCR/DVR OUT jack. See pages 27 to 43 for hookup information.

**1**



**Use the input selector buttons to select the source that you want to record.**

You can watch the source while recording. The AV receiver/AV amplifier's MASTER VOLUME control has no effect on recording.

**2**

**On your recorder, start recording.**

**3**

**On the source component, start playback.**

If you select another input source during recording, that input source will be recorded.

## Recording Separate AV Sources

Here you can record audio and video from completely separate sources, allowing you to overdub audio onto your video recordings. This function takes advantage of the fact that when an audio-only input source (i.e., TAPE, TUNER, or CD) is selected, the video input source remains unchanged.

In the following example, audio from the CD player connected to the CD IN, and video from the camcorder connected to the AUX INPUT VIDEO jack are recorded by the VCR connected to the VCR/DVR OUT jacks.

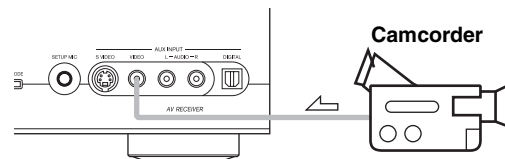

▷ : video signal  
◀ : audio signal

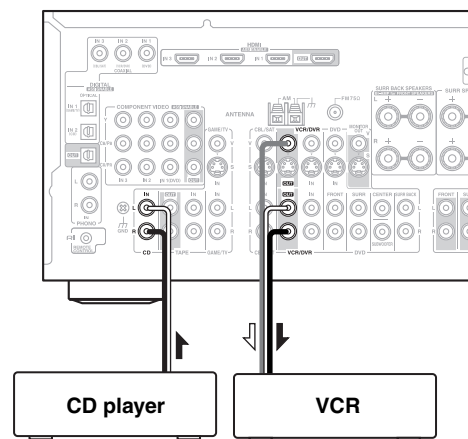

- 1 Prepare the camcorder and CD player for playback.**
- 2 Prepare the VCR for recording.**
- 3 Press the [AUX] input selector button.**
- 4 Press the [CD] input selector button.**  
This selects the CD player as the audio source, but leaves the camcorder as the video source.
- 5 Start recording on the VCR and start playback on the camcorder and CD player.**  
The video from the camcorder and the audio from the CD player are recorded by the VCR.

# Advanced Operations

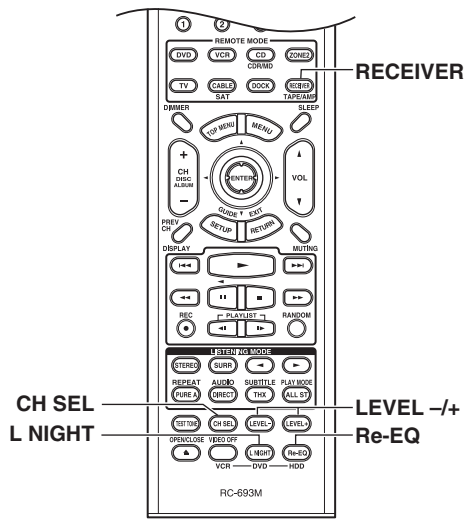

## Using the Re-EQ Function

With the Re-EQ function, you can compensate a soundtrack whose high-frequency content is too harsh, making it more suitable for home theater viewing. This function can be used with the following listening modes: Dolby Digital, Dolby Digital EX, Dolby Pro Logic II Movie, Dolby Pro Logic IIx Movie, DTS, DTS-ES, DTS Neo:6 Cinema, DTS 96/24, THX Cinema, THX Surround EX, THX Select2 Cinema, and Multichannel.

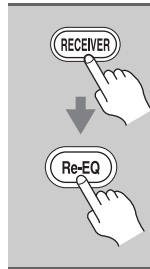

**Press the [RECEIVER] REMOTE MODE button, followed by the [Re-EQ] button.**

Press the [Re-EQ] button again to turn off the Re-EQ function.

## Using the Late Night Function (Dolby Digital, Dolby Digital Plus, and Dolby TrueHD only)

With the Late Night function, you can reduce the dynamic range of Dolby Digital, Dolby Digital Plus, and Dolby TrueHD material so that you can still hear quiet parts even when listening at low volume levels—ideal for watching movies late at night when you don't want to disturb anyone.



**Press the [RECEIVER] button, and then press the [L NIGHT] button repeatedly to select:**

**Dolby Digital, Dolby Digital Plus:**

- Off:** Late Night function off (default).
- Low:** Small reduction in dynamic range.
- High:** Big reduction in dynamic range.

**Dolby TrueHD:**

- Auto:** The Late Night function is set to On or Off automatically (default).
- Off:** Late Night function off.
- On:** Late Night function on.

**Notes:**

- Depending on the design of the contents, there are some materials that will show no effect even when the Late Night mode is operating.
- The Late Night function resets to the default when the AV receiver/AV amplifier is set to Standby.

## Adjusting Individual Speaker Levels

You can adjust the level of individual speakers during playback. These adjustments are temporary and will be cancelled when the AV receiver/AV amplifier is set to Standby.



**Press the [RECEIVER] button, use the [CH SEL] button to select each speaker, and use the [LEVEL-] and [LEVEL+] buttons to adjust the volume.**

Speakers are selected in the following order: Front Left → Center → Front Right → Surr Right → Surr Back Right → Surr Back Left → Surr Left → Subwoofer.

You can adjust the volume of each speaker from -12 dB to +12 dB (-15 dB to +12 dB for the subwoofer) in 1 dB steps.

The name of the currently selected speaker and its volume appear on the display, as shown.



**Notes:**

- You cannot use this function while the AV receiver/AV amplifier is muted.
- Speakers that are set to No or None in the Speaker Configuration cannot be adjusted.

# Advanced Setup

## About the Onscreen Setup Menus

The onscreen setup menus are displayed on the connected TV and provide a convenient way to change the AV receiver/AV amplifier's settings.

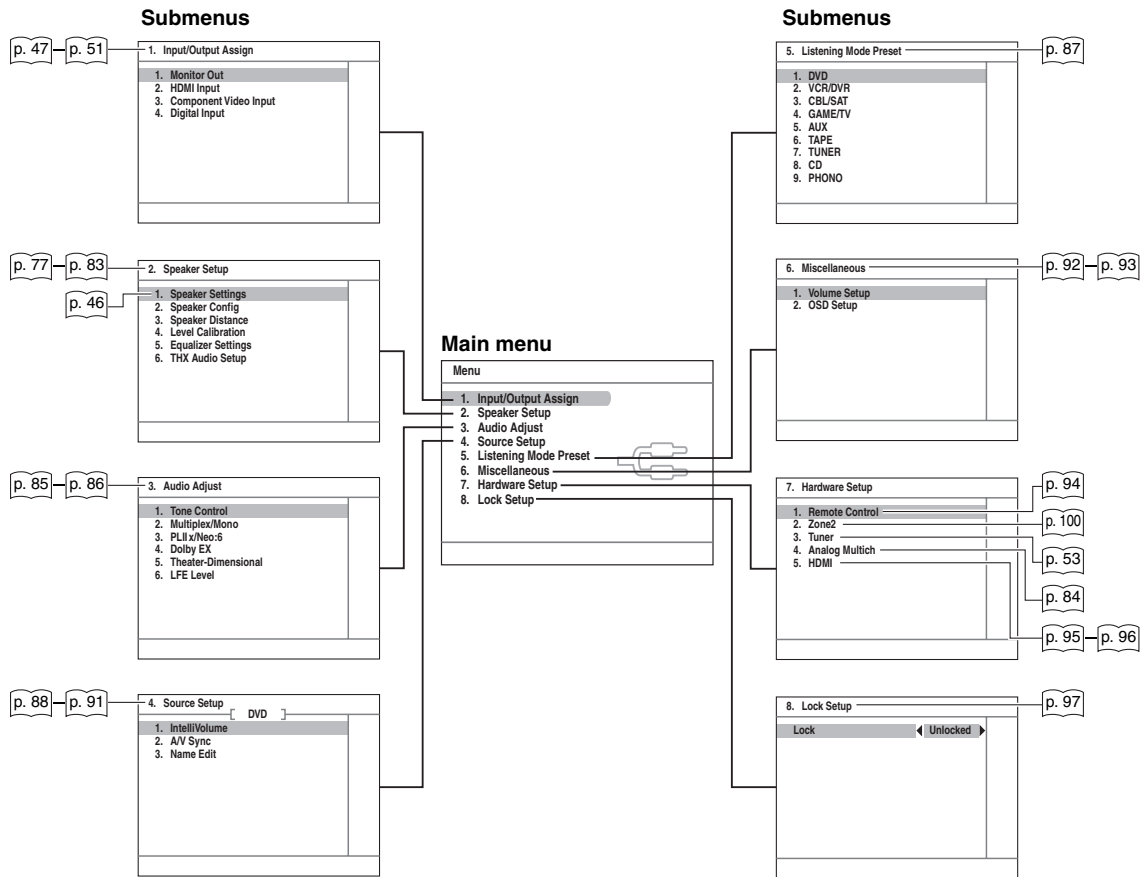

## Advanced Setup—Continued

### Speaker Setup

Some of the settings in this section are set automatically by the Automatic Speaker Setup function (see page 54). Here you can check the settings made by the Automatic Speaker Setup function, or set them manually, which is useful if you change one of the connected speakers after using the Automatic Speaker Setup function.

**Note:**

The Speaker Setup cannot be carried out while headphones are connected to the AV receiver/AV amplifier.

### Speaker Settings

See “Speaker Settings” on page 46.

### Speaker Configuration

This setting is set automatically by the Automatic Speaker Setup function (see page 54).

With these settings, you can specify which speakers are connected and a crossover frequency for each speaker.

The following crossover frequencies can be specified: Full Band, 40 Hz, 50 Hz, 60 Hz, 70 Hz, 80 Hz (THX), 90 Hz, 100 Hz, 120 Hz, 150 Hz, or 200 Hz.

Specify Full Band for speakers that can output low-frequency bass sounds adequately, for example, speakers with a good sized woofer. For smaller speakers, specify a crossover frequency. Sounds below the crossover frequency will be output by the subwoofer instead of the speaker. Refer to your speaker’s manuals to determine the optimum crossover frequencies.

Please note that any THX main speakers should be set to Small [80 Hz (THX)]. If you set up your speakers using the Automatic Speaker Setup function, please make sure manually that any THX speakers are set to Small with 80 Hz (THX) crossover.

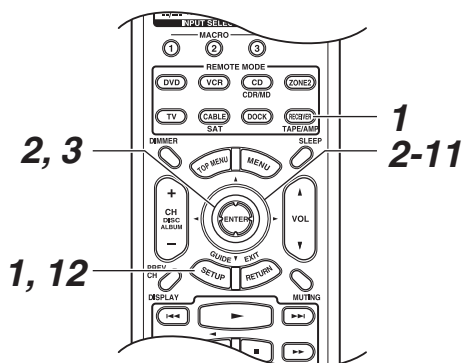

**1**



Press the [RECEIVER] button followed by the [SETUP] button. The main menu appears onscreen.

**2**



Use the Up and Down [▲]/[▼] buttons to select “2. Speaker Setup,” and then press [ENTER]. The Speaker Setup menu appears.

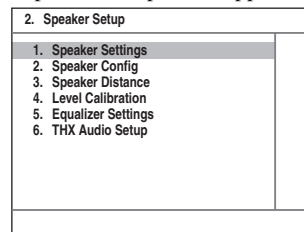

**3**

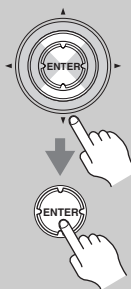

Use the Up and Down [▲]/[▼] buttons to select “2. Speaker Config,” and then press [ENTER]. The Speaker Config menu appears.

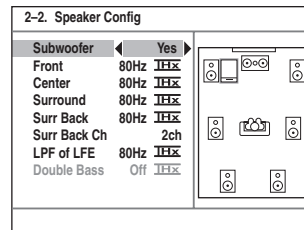



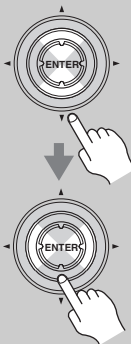

**4**



Use the Up and Down [▲]/[▼] buttons to select “Subwoofer,” and then use the Left and Right [◀]/[▶] buttons to select:

- Yes:** Select if a subwoofer is connected.
- No:** Select if no subwoofer is connected.

## Advanced Setup—Continued

- 5** Use the Up and Down [▲]/[▼] buttons to select “Front,” and then use the Left and Right [◀]/[▶] buttons to select a crossover frequency.
- Note:**  
If the Subwoofer setting in step 4 is set to No, this setting is fixed at Full Band.
- 
- 6** Use the Up and Down [▲]/[▼] buttons to select “Center,” and then use the Left and Right [◀]/[▶] buttons to select a crossover frequency.
- If no center speaker is connected, select None.
- Note:**  
If the Front setting in step 5 is set to anything other than Full Band, Full Band cannot be selected here.
- 
- 7** Use the Up and Down [▲]/[▼] buttons to select “Surround,” and then use the Left and Right [◀]/[▶] buttons to select a crossover frequency.
- If no surround left and right speakers are connected, select None.
- Note:**  
If the Front setting in step 5 is set to anything other than Full Band, Full Band cannot be selected here.
- 
- 8** Use the Up and Down [▲]/[▼] buttons to select “Surr Back,” and then use the Left and Right [◀]/[▶] buttons to select a crossover frequency.
- If no surround back speakers are connected, select None.
- Notes:**
- If the Surround setting in step 7 is set to None, this setting cannot be selected.
  - If the Surround setting in step 7 is set to anything other than Full Band, Full Band cannot be selected here.
- 

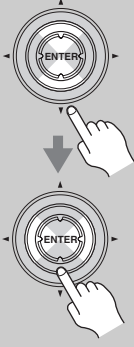
- 9** Use the Up and Down [▲]/[▼] buttons to select “Surr Back Ch,” and then use the Left and Right [◀]/[▶] buttons to select:
- 1ch:** Select if one surround back speaker is connected.
- 2ch:** Select if two (left and right) surround back speakers are connected.
- Note:**  
If the Surr Back Setting in step 8 is set to None, this setting cannot be selected.  
Continue with step 10 below.
- 

### Low-Pass Filter for the LFE Channel

This setting is **not** set automatically by the Automatic Speaker Setup function (see page 54).

With this setting, you can specify the cutoff frequency of the LFE channel’s low-pass filter (LPF), which can be used to filter out unwanted hum. The LPF only applies to sources that use the LFE channel.

\*If you’re using THX-certified speakers, select 80 Hz (THX).

- 10** Use the Up and Down [▲]/[▼] buttons to select “LPF of LFE,” and then use the Left and Right [◀]/[▶] buttons to select a low-pass filter frequency.
- The following low-pass filter frequencies can be selected: 80 Hz (THX), 90 Hz, 100 Hz, or 120 Hz.
- Continue with step 11 on page 79.
- 

## Advanced Setup—Continued



### Double Bass

This setting is **not** set automatically by the Automatic Speaker Setup function (see page 54).

With the Double Bass function, you can boost bass output by feeding bass sounds from the front left and right channels to the subwoofer. This function can be set only if the Subwoofer setting in step 4 is set to Yes, and the Front setting in step 5 is set to Full Band.

In the speaker setup screen, you can choose how bass information is distributed to your speakers only if you have large front left and right speakers and a subwoofer.

\*If you're using THX-certified speakers, select Off (THX).

<p><b>11</b></p> 	<p><b>Use the Up and Down [▲]/[▼] buttons to select “Double Bass,” and then use the Left and Right [◀]/[▶] buttons to select:</b></p> <p><b>On:</b> Double Bass function on (default). Front left and right bass also goes to the subwoofer simultaneously.</p> <p><b>Off (THX):</b> Double Bass function off.</p>
<p><b>12</b></p> 	<p><b>Press the [SETUP] button.</b> The setup menu closes.</p>

**Note:**

This procedure can also be performed on the AV receiver/AV amplifier by using its [SETUP] button, arrow buttons, and [ENTER] button.

## Advanced Setup—Continued

### Speaker Distance

This setting is set automatically by the Automatic Speaker Setup function (see page 54).

Here you can specify the distance from each speaker to the listening position so that the sound from each speaker arrives at the listener's ears as the sound designer intended.

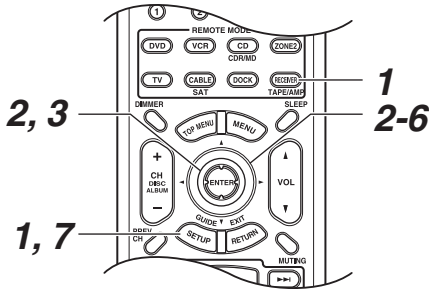

**1** Press the [RECEIVER] button followed by the [SETUP] button. The main menu appears onscreen.

**2** Use the Up and Down [▲]/[▼] buttons to select "2. Speaker Setup," and then press [ENTER]. The Speaker Setup menu appears.

2. Speaker Setup	
1. Speaker Settings	
2. Speaker Config	
3. Speaker Distance	
4. Level Calibration	
5. Equalizer Settings	
6. THX Audio Setup	

**3** Use the Up and Down [▲]/[▼] buttons to select "3. Speaker Distance," and then press [ENTER]. The Speaker Distance menu appears.

2-3. Speaker Distance		
Unit	feet	
Left	12.0ft	
Center	12.0ft	
Right	12.0ft	
Surr Right	7.0ft	
Surr Back R	7.0ft	
Surr Back L	7.0ft	
Surr Left	7.0ft	
Subwoofer	12.0ft	

**Note:**

Speakers that you set to No or None on the Speaker Configuration page (page 77) cannot be selected.

**4** Use the Up and Down [▲]/[▼] buttons to select "Unit," and then use the Left and Right [◀]/[▶] buttons to select:

**feet:** Select if you want to enter distances in feet. Can be set from 0.5 to 30 feet in 0.5-foot steps.

**meters:** Select if you want to enter distances in meters. Can be set from 0.15 to 9 meters in 0.15-meter steps.

**5** Use the Up and Down [▲]/[▼] buttons to select "Left," and then use the Left and Right [◀]/[▶] buttons to specify the distance. Specify the distance from the front left speaker to your listening position.

**6** Repeat step 5 for all speakers.

**7** Press the [SETUP] button. The setup menu closes.

**Notes:**

- The Center and Subwoofer distances can be set up to 5 ft. (1.5 m) more or less than the Front distance. For example, if the Front distance is set to 20 ft. (6 m), the Center and Subwoofer distances can be set between 15 and 25 ft. (4.5 and 7.5 m). The Surr Right, Surr Left, Surr Back R, and Surr Back L distances can be set up to 5 ft. (1.5 m) more or 15 ft. (4.5 m) less than the Front distance. For example, if the Front distance is set to 20 ft. (6 m), the Surr Right, Surr Left, Surr Back R, and Surr Back L distances can be set between 5 and 25 ft. (1.5 and 7.5 m).
- This procedure can also be performed on the AV receiver/AV amplifier by using its [SETUP] button, arrow buttons, and [ENTER] button.

## Advanced Setup—Continued

### Speaker Level Calibration

This setting is set automatically by the Automatic Speaker Setup function (see page 54).

Here you can adjust the level of each speaker with the built-in test tone so that the volume of each speaker is the same at the listening position.

**Notes:**

- The speakers cannot be calibrated while the output of the AV receiver/AV amplifier is muted.
- The test tone is output at the standard level for THX, which is 0 dB (absolute volume setting 82). If you normally listen at volume settings below this, be careful because the test tone will be much louder.

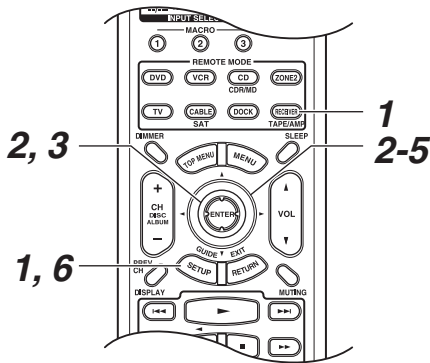

**1**



**Press the [RECEIVER] button followed by the [SETUP] button.**  
The main menu appears onscreen.

**2**

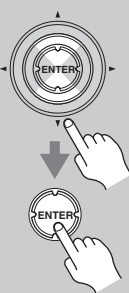

**Use the Up and Down [▲]/[▼] buttons to select “2. Speaker Setup,” and then press [ENTER].**  
The Speaker Setup menu appears.

2. Speaker Setup	
1. Speaker Settings	
2. Speaker Config	
3. Speaker Distance	
4. Level Calibration	
5. Equalizer Settings	
6. THX Audio Setup	

**3**



**Use the Up and Down [▲]/[▼] buttons to select “4. Level Calibration,” and then press [ENTER].**  
The Level Calibration menu appears and the pink noise test tone is output by the front left speaker.

2-4. Level Calibration	
Left	0dB
Center	0dB
Right	0dB
Surr Right	0dB
Surr Back R	0dB
Surr Back L	0dB
Surr Left	0dB
Subwoofer	0dB

**Note:**  
Speakers that you set to No or None on the Speaker Configuration page (page 77) cannot be selected.

**4**



**Use the Up and Down [▲]/[▼] buttons to select each speaker, and use the Left and Right [◀]/[▶] buttons to set the volume.**  
The volume can be adjusted from -12 to +12 dB (-15 dB to +12 dB for the subwoofer) in 1 dB steps.

**5**

**Repeat step 4 until the volume of the test tone from each speaker is the same.**

**6**



**Press the [SETUP] button.**  
The setup menu closes.

**Notes:**

- This procedure can also be performed by using the [TEST TONE] button, [LEVEL-] and [LEVEL+] buttons. First press the [TEST TONE] button to output the test tone. Use the [LEVEL-] and [LEVEL+] buttons to set the volume, and use the [CH SEL] button to select the speakers.
- This procedure can also be performed on the AV receiver/AV amplifier by using its [SETUP] button, arrow buttons, and [ENTER] button.

## Advanced Setup—Continued

### Equalizer Setting

This setting is set automatically by the Automatic Speaker Setup function (see page 54).

Here you can adjust the EQ of individual speakers. To set the volume of individual speakers see page 81.

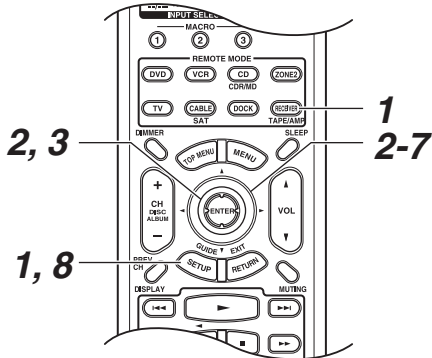

**1**

**Press the [RECEIVER] button followed by the [SETUP] button.**  
The main menu appears onscreen.

**2**

**Use the Up and Down [▲]/[▼] buttons to select “2. Speaker Setup,” and then press [ENTER].**  
The Speaker Setup menu appears.

2. Speaker Setup	
1. Speaker Settings	
2. Speaker Config	
3. Speaker Distance	
4. Level Calibration	
5. Equalizer Settings	
6. THX Audio Setup	

**3**

**Use the Up and Down [▲]/[▼] buttons to select “5. Equalizer Settings,” and then press [ENTER].**  
The Equalizer Settings menu appears.

2-5. Equalizer Settings	
Equalizer	Off

**4**

**Use the Left and Right [◀]/[▶] buttons to select:**

- Off:** Tone off, response flat.
- Audyssey:** The tone for each speaker is set automatically by the Automatic Speaker Setup function.  
Be sure to select this setting after having performed the Automatic Speaker Setup.
- Manual:** You can adjust the EQ of each speaker manually.



If you select Manual, continue with this procedure. If you select Off or Audyssey, go to step 8.

**5**

**Use the Down [▼] button to select “Channel,” and then use the Left and Right [◀]/[▶] buttons to select a speaker.**

2-5. Equalizer Settings	
Equalizer	Manual
Channel	Front
63Hz	0dB
160Hz	0dB
400Hz	0dB
1000Hz	0dB
2500Hz	0dB
6300Hz	0dB
16000Hz	0dB

## Advanced Setup—Continued

- 6** Use the Up and Down [▲]/[▼] buttons to select a frequency, and then use the Left and Right [◀]/[▶] buttons to adjust the level at that frequency.
- 
- The volume at each frequency can be adjusted from -6 to +6 dB in 1 dB steps.
- Tip:** Low frequencies (e.g., 160 Hz) affect bass sounds; high frequencies (e.g., 6300 Hz) affect treble sounds.
- 7** Use the Up [▲] button to select “Channel,” and then use the Left and Right [◀]/[▶] buttons to select another speaker.
- 
- Repeat step 6 and 7 for each speaker.
- 8** Press the [SETUP] button.
- 
- The setup menu closes.



### Notes:

- When the listening mode is set to Direct or Pure Audio, no effect will be produced.
- Depending on the input source or listening mode, the Equalizer settings may not produce the desired effect.
- This procedure can also be performed on the AV receiver/AV amplifier by using its [SETUP] button, arrow buttons, and [ENTER] button.

## THX Audio Setup

These settings are not set automatically by the Automatic Speaker Setup function (see page 54).

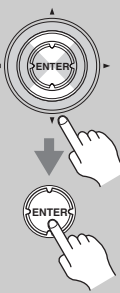
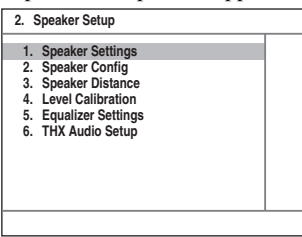
With the Surr Back Sp Spacing setting, you can specify the distance between your surround back speakers.

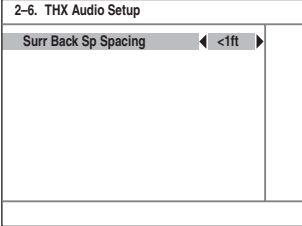
- 1** Press the [RECEIVER] REMOTE MODE button, followed by the [SETUP] button.
- 
- The main menu appears onscreen.
- 2** Use the Up and Down [▲]/[▼] buttons to select “2. Speaker Setup,” and then press [ENTER].
- 
- The Speaker Setup menu appears.
- 
- 3** Use the Up and Down [▲]/[▼] buttons to select “6. THX Audio Setup,” and then press [ENTER].
- 
- The THX Audio Setup screen appears.
- 

## Advanced Setup—Continued

**4**



**Use the Left and Right [◀]/[▶] buttons to specify the distance between your surround back speakers:**

**< 1 ft (< 0.3 m) (Default):** Select this if your surround back speakers are between 0 and 1 foot (0–30 cm) apart.

**1–4 ft (0.3–1.2 m):** Select this if your surround back speakers are between 1 and 4 feet (0.3–1.2 m) apart.

**>4 ft (>1.2 m):** Select this if your surround back speakers are more than 4 feet (1.2 m) apart.

**Note:**  
This setting is only available if the Surr Back Ch setting in the Speaker Configuration is set to 2ch (page 78).

---

**5**



**Press the [SETUP] button.**  
The setup menu closes.

**Note:**

- This procedure can also be performed on the AV receiver/AV amplifier by using its [SETUP], [ENTER], and arrow buttons.

### Multichannel DVD Input Settings

#### Subwoofer Input Sensitivity

Some DVD players output the LFE channel from their subwoofer output at 15 dB higher than normal. You can change the subwoofer sensitivity to match your DVD player. Note that this setting only affects signals connected to the SUBWOOFER input jack of the multichannel DVD input.

**1**



**Press the [RECEIVER] button followed by the [SETUP] button.**  
The main menu appears onscreen.

**2**



**Use the Up and Down [▲]/[▼] buttons to select “7. Hardware Setup,” and then press [ENTER].**  
The Hardware Setup menu appears.

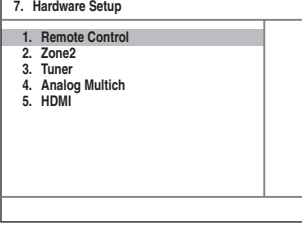



---

**3**

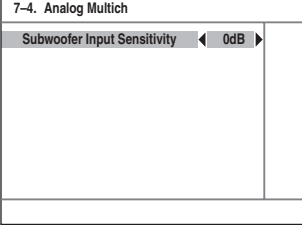

**Use the Up and Down [▲]/[▼] buttons to select “4. Analog Multich,” and then press [ENTER].**  
The Analog Multich menu appears.



---

**4**



**Use the Left and Right [◀]/[▶] buttons to select a value.**  
You can select 0 dB, 5 dB, 10 dB, or 15 dB.  
If you find that your subwoofer is too loud, try the 10 dB or 15 dB setting.

---

**5**



**Press the [SETUP] button.**  
The setup menu closes.

**Note:**

This procedure can also be performed on the AV receiver/AV amplifier by using its [SETUP] button, arrow buttons, and [ENTER] button.

## Advanced Setup—Continued

### Audio Adjust Functions

Here you can set listening mode-related settings and functions.

**1**



Press the [RECEIVER] button followed by the [SETUP] button.

The main menu appears onscreen.

**2**

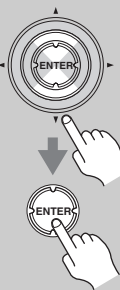

Use the Up and Down [▲]/[▼] buttons to select “3. Audio Adjust,” and then press [ENTER].

The Audio Adjust menu appears.

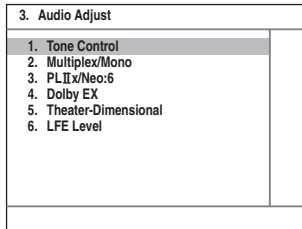

**3**

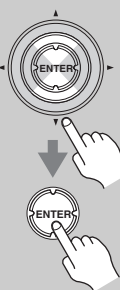

Use the Up and Down [▲]/[▼] buttons to select the functions, and then press [ENTER].

The function menu you selected appears.

**4**

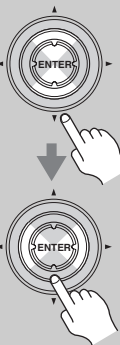

Use the Up and Down [▲]/[▼] buttons to select the settings, and use the Left and Right [◀]/[▶] buttons to set them.

The settings are explained below.

**5**



When you've finished, press the [SETUP] button.

The setup menu closes.

#### Note:

This procedure can also be performed on the AV receiver/AV amplifier by using its [SETUP] button, arrow buttons, and [ENTER] button.

The Audio Adjust functions are explained below.

### Tone Control Settings

You can adjust the bass and treble for the front speakers, except when the Direct or Pure Audio listening mode is selected.

#### ■ Bass

You can boost or cut low-frequency sounds output by the front speakers from  $-10$  dB to  $+10$  dB in 2 dB steps.

#### ■ Treble

You can boost or cut high-frequency sounds output by the front speakers from  $-10$  dB to  $+10$  dB in 2 dB steps.

#### Note:

The tone control settings do not apply to the THX listening modes.

### Multiplex/Mono Settings

#### ■ Multiplex Input Ch

This setting determines which channel is output from a stereo multiplex source. Use it to select audio channels or languages with multiplex sources, multilingual TV broadcasts, and so on.

**Main:** The main channel is output (default).

**Sub:** The sub channel is output.

**Main/Sub:** Both the main and sub channels are output.

#### ■ Mono Input Ch

This setting specifies the channel to be used for playing any 2-channel digital source such as Dolby Digital, or 2-channel analog/PCM source in the Mono listening mode.

**L+R:** Both the left and right channels are output (default).

**L:** Only the left channel is output.

**R:** Only the right channel is output.

#### ■ Output Speaker

This setting determines which speakers output mono audio when the Mono listening mode is selected.

**L/R:** Mono audio is output by the front left and right speakers.

**C:** Mono audio is output by the center speaker (default).

## Advanced Setup—Continued

### PLIIx/Neo:6 Music Mode Settings

These settings provide for playing any 2-channel digital source such as Dolby Digital, or 2-channel analog/PCM source in the Dolby PLIIx Music listening mode.

#### ■ Panorama

With this function, you can broaden the width of the front stereo image when using the Dolby Pro Logic II Music or Dolby Pro Logic IIX Music listening mode.

**On:** Panorama function on.

**Off:** Panorama function off (default).

#### ■ Dimension

With this setting, you can move the sound field forward or backward when using the Dolby Pro Logic II Music or Dolby Pro Logic IIX Music listening mode. It can be adjusted from -3 to +3 (default is 0). Lower settings move the sound field forward. Higher settings move it backward.

If the stereo image feels too wide, or there is too much surround sound, move the sound field forward to improve the balance. Conversely, if the stereo image feels like it is in mono, or there is not enough surround sound, move it backward.

#### ■ Center Width

With this function, you can adjust the width of the sound from the center speaker when using the Dolby Pro Logic II Music or Dolby Pro Logic IIX Music listening mode. Normally

if you are using a center speaker, the center channel sound is output by only the center speaker. (If you are not using a center speaker, the center channel sound will be distributed to the front left and right speakers to create a phantom center.) This setting controls the front left, right, and center mix, allowing you to adjust the weight of the center channel sound. It can be adjusted from 0 to 7 (default is 3).

#### ■ Center Image

The DTS Neo:6 Music listening mode creates 6-channel surround sound from 2-channel (stereo) sources. With this setting, you can specify by how much the front left and right channel output is attenuated in order to create the center channel. It can be adjusted from 0 to 5 (default is 2). This setting is unavailable if no surround speakers are connected.

When set to 0, the front left and right channel output is attenuated by half (-6 dB), giving the impression that the sound is located centrally. This setting works well when the listening position is considerably off center. When set to 5, the front left and right channels are not attenuated, maintaining the original stereo balance.

### Dolby EX Input Signal Setting

#### ■ Dolby EX

This setting determines how Dolby EX encoded signals are handled. This setting is unavailable if no surround back speakers are connected. This setting is effective with Dolby Digital and Dolby Digital Plus only.

**Auto:** If the source signal contains a Dolby EX flag, the Dolby EX or THX Surround EX listening mode is used (default).

**Manual:** You can select any available listening mode.

### T-D (Theater-Dimensional) Listening Setting

#### ■ Listening Angle

With this setting, you can specify the angle of the front left and right speakers relative to the listening position. Processing for the Theater-Dimensional listening mode is based on this setting. Ideally, the front left and right speakers should be equidistant from the listening position and at an angle close to one of the two available settings.

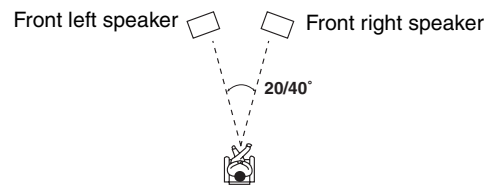

**Narrow:** Select if the listening angle is 20 degrees.

**Wide:** Select if the listening angle is 40 degrees (default).

### LFE Level Settings

With these settings, you can set the level of the LFE (Low Frequency Effects) channel individually for Dolby Digital, DTS, multichannel PCM, **Dolby TrueHD, DTS-HD Master Audio, and DSD sources**. The level can be set to  $-\infty$ , -20 dB, -10 dB, or 0 dB (default).

If you find that low-frequency effects are too loud when using one of these sources, change the setting to -20 dB or  $-\infty$ , dB.

#### ■ Dolby Digital

Sets the level of the LFE channel for Dolby Digital sources.

#### ■ DTS

Sets the level of the LFE channel for DTS sources.

#### ■ Multichannel PCM

Sets the level of the LFE channel for multichannel PCM sources. (Multichannel PCM is input via HDMI.)

#### ■ Dolby TrueHD

Sets the level of the LFE channel for Dolby TrueHD sources.

#### ■ DTS-HD Master Audio

Sets the level of the LFE channel for DTS-HD Master Audio sources.

#### ■ DSD

Sets the level of the LFE channel for DSD (SACD) sources.

## Advanced Setup—Continued

### Assigning Listening Modes to Input Sources

You can assign a default listening mode to each input source that will be selected automatically when you select each input source. For example, you can set the default listening mode to be used with Dolby Digital input signals. You can select other listening modes during playback, but the mode specified here will be resumed once the AV receiver/AV amplifier has been set to Standby.

**1**



Press the [RECEIVER] button followed by the [SETUP] button.

The main menu appears onscreen.

**2**

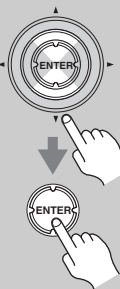

Use the Up and Down [▲]/[▼] buttons to select “5. Listening Mode Preset,” and then press [ENTER].

The Listening Mode Preset menu appears.

5. Listening Mode Preset	
1. DVD	
2. VCR/DVR	
3. CBL/SAT	
4. GAME/TV	
5. AUX	
6. TAPE	
7. TUNER	
8. CD	
9. PHONO	

**3**

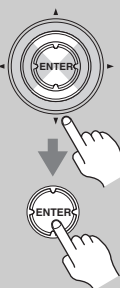

Use the Up and Down [▲]/[▼] buttons to select the input source that you want to set, and then press [ENTER].

The signal format selection menu appears.

5-1. Listening Mode Preset - DVD -	
Analog/PCM	Last Valid
Dolby Digital	Last Valid
DTS	Last Valid
D.F. 2ch	Last Valid
D.F. Mono	Last Valid

For input selectors that have no digital input jacks, only “Analog” will be available (TX-SR705 only).

**4**

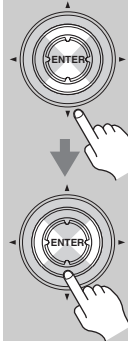

Use the Up and Down [▲]/[▼] buttons to select the signal format that you want to set, and then use the Left and Right [◀]/[▶] buttons to select a listening mode.

Only listening modes that can be used with each input signal format can be selected.

The Last Valid option means that the listening mode selected last will be used.

**Analog/PCM:** With this setting, you can specify the listening mode to be used when an analog (CD, TV, LD, VHS, MD, turntable, radio, cassette, cable, satellite, etc.) or PCM digital (CD, DVD, etc.) audio signal is played.

**Dolby Digital:** With this setting, you can specify the listening mode to be used when a Dolby Digital format digital audio signal is played (DVD, etc.).

**DTS:** With this setting, you can specify the listening mode to be used when a DTS format digital audio signal is played (DVD, LD, CD, etc.).

**D.F. 2ch:** With this setting, you can specify the listening mode to be used when a 2-channel (2/0) digital audio signal (Dolby Digital, DTS) is played (DVD, etc.).

**D.F. Mono:** With this setting, you can specify the listening mode to be used when a mono digital audio signal is played (DVD, etc.).

**Multich PCM:** Specifies the default listening mode for multichannel PCM sources input via a HDMI IN, such as DVD-Audio.

**192k/176.4k:** Specifies the default listening mode for high resolution 176.4 kHz and 192 kHz digital audio sources such as DVD-Audio.

**Dolby TrueHD:** Specifies the default listening mode for Dolby TrueHD sources, such as Blu-ray or HD DVD (input via HDMI).

**DTS-HD Master Audio:** Specifies the default listening mode for DTS-HD Master Audio sources, such as Blu-ray or HD DVD (input via HDMI).

**DSD:** Specifies the default listening mode for DSD multichannel sources, such as SACD.

## Advanced Setup—Continued

**5** When you've finished, press the [SETUP] button. The setup menu closes.



**Note:**  
This procedure can also be performed on the AV receiver/AV amplifier by using its [SETUP] button, arrow buttons, and [ENTER] button.

### Source Setup

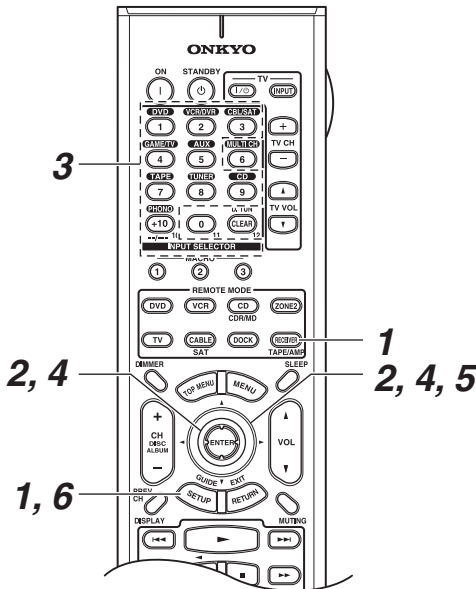

#### IntelliVolume

You can set the input level for each input source. This is useful if some of your AV components are louder or quieter than others. IntelliVolume does not affect Zone 2. While this menu is shown onscreen, you can select each input source and set the levels while listening to and comparing them.

**1** Press the [RECEIVER] button followed by the [SETUP] button. The main menu appears onscreen.

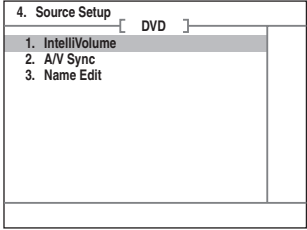

**2** Use the Up and Down [▲]/[▼] buttons to select "4. Source Setup," and then press [ENTER]. The Source Setup menu appears.

**3** Use the INPUT SELECTOR buttons on the remote controller to select the input source that you want to set.



**4** Use the Up and Down [▲]/[▼] buttons to select "1. IntelliVolume," and then press [ENTER]. The IntelliVolume menu appears.

**5** If a component is too loud compared to your other components, use the Left [◀] button to adjust the level. If it's too quiet, use the Right [▶] button.

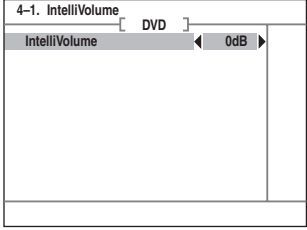
- The level can be set from -12 dB to +12 dB in 1 dB steps.



**6** When you're finished, press the [SETUP] button. The setup menu closes.



## Advanced Setup—Continued

### Correcting Sound and Picture Sync

When using progressive scanning on your DVD player, you may find that the picture and sound are out of sync. With this setting, you can correct this by delaying the audio signals. You can set it from 0 to 250 milliseconds (msec) in 5 millisecond steps.

**1** Press the [RECEIVER] button followed by the [SETUP] button. The main menu appears onscreen.



**2** Use the Up and Down [▲]/[▼] buttons to select “4. Source Setup,” and then press [ENTER]. The Source Setup menu appears.



4. Source Setup		[ DVD ]
1.	IntelliVolume	
2.	A/V Sync	
3.	Name Edit	

**3** Use the INPUT SELECTOR buttons on the remote controller to select the input source that you want to correct.



DVD	VCR/DVDR	CD/SATA
1	2	3
GAME-TV	AUX	
4	5	
TAPE	TUNER	CD
7	8	9
PHONE	+10	

**4**

Use the Up and Down [▲]/[▼] buttons to select “2. A/V Sync,” and then press [ENTER].

The A/V Sync menu appears.

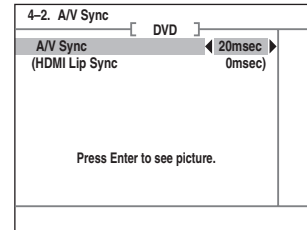

If HDMI Lip Sync is enabled (see page 95), and your TV or display supports HDMI Lip Sync, the HDMI Lip Sync delay time is displayed underneath in parentheses.

**5**

Press [ENTER] to view the TV picture, and use the Left and Right [◀]/[▶] buttons to adjust the delay from 0 to 250 milliseconds in 5 millisecond steps.



#### Notes:



- This setting is not available when the Pure Audio listening mode is used, or the Direct listening mode is used with an analog input signal.
- This procedure can also be performed on the remote controller by using INPUT SELECTOR buttons. Press and hold, for more than 5 seconds, the INPUT SELECTOR button for the input source that you want to correct. Use the Left and Right [◀]/[▶] buttons to adjust the delay.

## Advanced Setup—Continued

### Name Edit

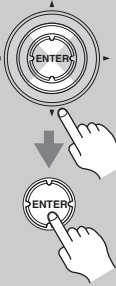
You can enter a custom name for each individual input selector and radio preset for easy identification. When selected, the custom name will appear on the display.

<b>1</b>	<p><b>Select the input selector to which you want to give a custom name.</b></p> <p>To name a radio preset, use the [TUNER] button to select AM or FM, and then select the preset.</p>				
<b>2</b>	<p><b>Press the [RECEIVER] REMOTE MODE button, followed by the [SETUP] button.</b></p> 				
<b>3</b>	<p><b>Use the Up and Down [▲]/[▼] buttons to select “4. Source Setup,” and then press [ENTER].</b></p> <p>The Source Setup menu appears.</p>  <div style="border: 1px solid black; padding: 5px; margin-top: 10px;"> <p>4. Source Setup [ DVD ]</p> <ul style="list-style-type: none"> <li>1. IntelliVolume</li> <li>2. A/V Sync</li> <li>3. Name Edit</li> </ul> </div>				
<b>4</b>	<p><b>Use the Up and Down [▲]/[▼] buttons to select “Name Edit,” and then press [ENTER].</b></p> <p>The Name Edit screen appears.</p>  <div style="border: 1px solid black; padding: 5px; margin-top: 10px;"> <p>4-3. Name Edit [ DVD ]</p> <table border="1" style="width: 100%; border-collapse: collapse;"> <thead> <tr> <th>Display</th> <th>Default</th> </tr> </thead> <tbody> <tr> <td>Name</td> <td></td> </tr> </tbody> </table> <p style="text-align: right; font-size: small;">[ENTER] : EDIT</p> </div> <p>If you're naming an item for the very first time, go to step 6. If the item already has a name, you can select Default or Custom in step 5.</p>	Display	Default	Name	
Display	Default				
Name					

<b>5</b>	<p><b>Use the Up and Down [▲]/[▼] buttons to select “Display,” and use the Left and Right [◀]/[▶] buttons to select:</b></p>  <p><b>Default:</b> The default name is displayed. <b>Custom:</b> The custom name is displayed.</p> <p>When Default is selected, the station's frequency appears on the display when a radio preset is selected.</p>																																																																														
<b>6</b>	<p><b>Press the Down [▼] button to select “Name,” and then press [ENTER] to open the character input screen.</b></p>  <div style="border: 1px solid black; padding: 5px; margin-top: 10px;"> <p>4-3. Name Edit</p> <p>Name [ ]</p> <table border="1" style="width: 100%; border-collapse: collapse; font-size: x-small;"> <tr><td>A</td><td>B</td><td>C</td><td>D</td><td>E</td><td>F</td><td>G</td><td>H</td><td>I</td><td>J</td><td>K</td><td>L</td><td>M</td></tr> <tr><td>N</td><td>O</td><td>P</td><td>Q</td><td>R</td><td>S</td><td>T</td><td>U</td><td>V</td><td>W</td><td>X</td><td>Y</td><td>Z</td></tr> <tr><td>a</td><td>b</td><td>c</td><td>d</td><td>e</td><td>f</td><td>g</td><td>h</td><td>i</td><td>j</td><td>k</td><td>l</td><td>m</td></tr> <tr><td>n</td><td>o</td><td>p</td><td>q</td><td>r</td><td>s</td><td>t</td><td>u</td><td>v</td><td>w</td><td>x</td><td>y</td><td>z</td></tr> <tr><td>0</td><td>1</td><td>2</td><td>3</td><td>4</td><td>5</td><td>6</td><td>7</td><td>8</td><td>9</td><td>-</td><td>_</td><td> </td></tr> <tr><td> </td><td> </td><td> </td><td> </td><td> </td><td> </td><td> </td><td> </td><td> </td><td> </td><td> </td><td> </td><td> </td></tr> </table> <p style="text-align: right; font-size: x-small;">[OK] [Cancel]</p> </div>	A	B	C	D	E	F	G	H	I	J	K	L	M	N	O	P	Q	R	S	T	U	V	W	X	Y	Z	a	b	c	d	e	f	g	h	i	j	k	l	m	n	o	p	q	r	s	t	u	v	w	x	y	z	0	1	2	3	4	5	6	7	8	9	-	_														
A	B	C	D	E	F	G	H	I	J	K	L	M																																																																			
N	O	P	Q	R	S	T	U	V	W	X	Y	Z																																																																			
a	b	c	d	e	f	g	h	i	j	k	l	m																																																																			
n	o	p	q	r	s	t	u	v	w	x	y	z																																																																			
0	1	2	3	4	5	6	7	8	9	-	_																																																																				
<b>7</b>	<p><b>Use the arrow [▲]/[▼]/[◀]/[▶] buttons to select a character, and then press [ENTER].</b></p> <p><b>Repeat this step to enter up to 10 characters.</b></p> <p><b>To correct a character:</b></p> <div style="border: 2px solid magenta; padding: 5px; margin: 5px 0;"> <p>1. Use the arrow [▲]/[▼]/[◀]/[▶] buttons to select “←”(Left) or “→”(Right) and then press [ENTER].</p> </div>  <div style="border: 1px solid black; padding: 5px; margin-top: 10px;"> <p>4-3. Name Edit</p> <p>Name [ 123456789 ]</p> <table border="1" style="width: 100%; border-collapse: collapse; font-size: x-small;"> <tr><td>A</td><td>B</td><td>C</td><td>D</td><td>E</td><td>F</td><td>G</td><td>H</td><td>I</td><td>J</td><td>K</td><td>L</td><td>M</td></tr> <tr><td>N</td><td>O</td><td>P</td><td>Q</td><td>R</td><td>S</td><td>T</td><td>U</td><td>V</td><td>W</td><td>X</td><td>Y</td><td>Z</td></tr> <tr><td>a</td><td>b</td><td>c</td><td>d</td><td>e</td><td>f</td><td>g</td><td>h</td><td>i</td><td>j</td><td>k</td><td>l</td><td>m</td></tr> <tr><td>n</td><td>o</td><td>p</td><td>q</td><td>r</td><td>s</td><td>t</td><td>u</td><td>v</td><td>w</td><td>x</td><td>y</td><td>z</td></tr> <tr><td>0</td><td>1</td><td>2</td><td>3</td><td>4</td><td>5</td><td>6</td><td>7</td><td>8</td><td>9</td><td>-</td><td>_</td><td> </td></tr> <tr><td> </td><td> </td><td> </td><td> </td><td> </td><td> </td><td> </td><td> </td><td> </td><td> </td><td> </td><td> </td><td> </td></tr> </table> <p style="text-align: right; font-size: x-small;">[OK] [Cancel]</p> <p style="text-align: center; font-size: x-small;">“ ← ” “ → ”</p> </div> <p>2. Press [ENTER] several times to select the incorrect character (The cursor moves one letter each time [ENTER] is pressed).</p> <p>3. Use the arrow [▲]/[▼]/[◀]/[▶] buttons to select the correct character, and then press [ENTER].</p>	A	B	C	D	E	F	G	H	I	J	K	L	M	N	O	P	Q	R	S	T	U	V	W	X	Y	Z	a	b	c	d	e	f	g	h	i	j	k	l	m	n	o	p	q	r	s	t	u	v	w	x	y	z	0	1	2	3	4	5	6	7	8	9	-	_														
A	B	C	D	E	F	G	H	I	J	K	L	M																																																																			
N	O	P	Q	R	S	T	U	V	W	X	Y	Z																																																																			
a	b	c	d	e	f	g	h	i	j	k	l	m																																																																			
n	o	p	q	r	s	t	u	v	w	x	y	z																																																																			
0	1	2	3	4	5	6	7	8	9	-	_																																																																				



## Advanced Setup—Continued

### Volume Setup/OSD Setup

This section explains the items on the Miscellaneous menu.

#### Volume Setup

- 1** Press the [RECEIVER] button followed by the [SETUP] button.



The main menu appears onscreen.

- 2** Use the Up and Down [▲]/[▼] buttons to select “6. Miscellaneous,” and then press [ENTER].



The Miscellaneous menu appears.

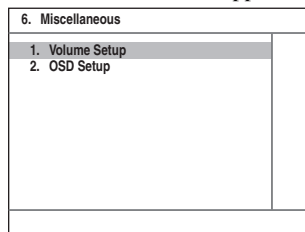

- 3** Use the Up and Down [▲]/[▼] buttons to select “1. Volume Setup,” and then press [ENTER].

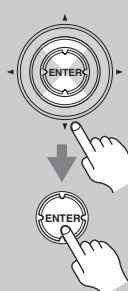

The Volume Setup menu appears.

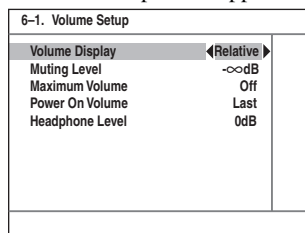

- 4** Use the Up and Down [▲]/[▼] buttons to select the settings, and use the Left and Right [◀]/[▶] buttons to set them.

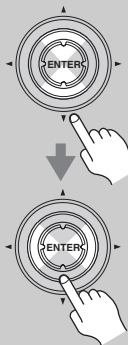

#### Volume Display

With this setting, you can choose how the volume level is displayed.

**Absolute:** Display range is Min, 1 through 99, Max.

**Relative:** Display range is  $-\infty$  dB,  $-81$  dB through  $+18$  dB.

The absolute value 82 is equivalent to the relative value 0 dB.

#### Muting Level

This setting determines how much the output is muted when the Muting function is used (see page 61). It can be set to  $-\infty$  dB (fully muted) or from  $-50$  dB to  $-10$  dB in 10 dB steps.

#### Maximum Volume

With this setting, you can limit the maximum volume.

When the Volume Display setting is set to Absolute, the Maximum Volume range is Off, 50 to 99.

When it's set to Relative, the range is Off,  $-32$  dB to  $+17$  dB. To disable this setting, select Off.

#### Power On Volume

With this preference, you can specify the volume setting to be used each time the AV receiver/AV amplifier is turned on.

When the Volume Display preference is set to Absolute, the range is Last, Min, 1 to 99 or Max.

When it's set to Relative, the range is Last,  $-\infty$  dB,  $-81$  dB to  $+18$  dB. To use the same volume level that was used when the AV receiver/AV amplifier was turned off, select Last.

The “Power On Volume” cannot be set higher than the “Maximum Volume” setting.

#### Headphone Level

With this preference, you can specify the headphone volume relative to the main volume. This is useful if there's a volume difference between your speakers and your headphones. The headphones level can be set from  $-12$  dB to  $+12$  dB.

- 5** When you've finished, press the [SETUP] button.



The setup menu closes.

#### Note:

This procedure can also be performed on the AV receiver/AV amplifier by using its [SETUP] button, arrow buttons, and [ENTER] button.

## Advanced Setup—Continued

### OSD Setup

**1** Press the [RECEIVER] button followed by the [SETUP] button. The main menu appears onscreen.



**2** Use the Up and Down [▲]/[▼] buttons to select "6. Miscellaneous," and then press [ENTER]. The Miscellaneous menu appears.



6. Miscellaneous	
1. Volume Setup	
2. OSD Setup	

**3** Use the Up and Down [▲]/[▼] buttons to select "2. OSD Setup," and then press [ENTER]. The OSD Setup menu appears.



6-2. OSD Setup	
Immediate Display	◀ On ▶
Monitor Type	4 : 3
Display Position	Bottom
TV Format	Auto

**4**

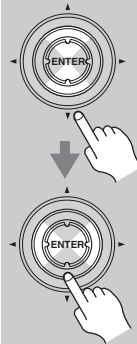

Use the Up and Down [▲]/[▼] buttons to select the settings, and use the Left and Right [◀]/[▶] buttons to set them.

These settings determine how the operation details are displayed.

#### Immediate Display

This preference determines whether operation details are displayed onscreen when an AV receiver/AV amplifier function is adjusted.

**On:** Displayed (default).

**Off:** Not displayed.

Even when On is selected, operation details may not be output if the input source is connected to a COMPONENT VIDEO IN or HDMI IN.

For optimal video performance, THX recommends that Immediate Display be turned off.

#### Monitor Type

With this preference, you can specify the aspect ratio of your TV so that the operation details are displayed properly.

**4 : 3:** Select if your TV is 4 : 3 (default).

**16 : 9:** Select if your TV is 16 : 9.

#### Display Position

This preference determines where on the screen operation details are displayed.

**Bottom:** Bottom of the screen (default).

**Top:** Top of the screen.

#### TV Format (not North American models)

See "TV Format Setup (not North American models)" on page 52.

**5**



When you've finished, press the [SETUP] button.

The setup menu closes.

#### Note:

This procedure can also be performed on the AV receiver/AV amplifier by using its [SETUP] button, arrow buttons, and [ENTER] button.

## Advanced Setup—Continued

### Changing the AV Receiver/AV Amplifier's ID

**Note:**

This procedure can also be performed on the AV receiver/AV amplifier by using its [SETUP] button, arrow buttons, and [ENTER] button.

- 1**



**Press the [RECEIVER] button followed by the [SETUP] button.**  
The main menu appears onscreen.
- 2**



**Use the Up and Down [▲]/[▼] buttons to select "7. Hardware Setup," and then press [ENTER].**  
The Hardware Setup menu appears.

7. Hardware Setup	
1. Remote Control	
2. Zone2	
3. Tuner	
4. Analog Multich	
5. HDMI	
- 3**

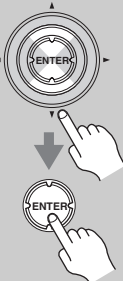

**Use the Up and Down [▲]/[▼] buttons to select "1. Remote Control," and then press [ENTER].**  
The Remote Control menu appears.

7-1. Remote Control	
Remote ID	◀ 1 ▶
- 4**



**Use the Left and Right [◀]/[▶] buttons to select a value.**

**Remote ID**  
With this setting, you can change the AV receiver/AV amplifier's remote control ID. You may need to change this if the remote controller's control codes overlap with those of another Onkyo component located in the same room.  
If you change the AV receiver/AV amplifier's remote control ID, be sure to set the same ID on both the AV receiver/AV amplifier and remote controller (see page 98). The default ID for both is 1.

## Advanced Setup—Continued

### HDMI Setup

**1**



Press the [RECEIVER] button followed by the [SETUP] button.

The main menu appears onscreen.

**2**

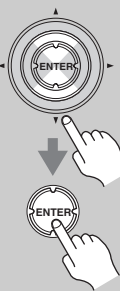

Use the Up and Down [▲]/[▼] buttons to select “7. Hardware Setup,” and then press [ENTER].

The Hardware Setup menu appears.

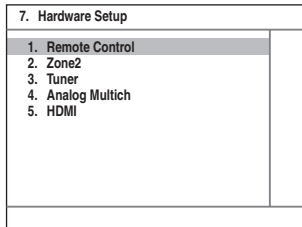

**3**



Use the Up and Down [▲]/[▼] buttons to select “5. HDMI,” and then press [ENTER].

The HDMI menu appears.

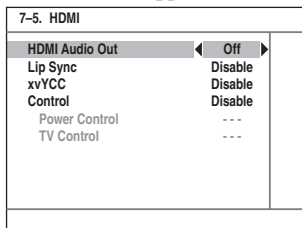

**4**

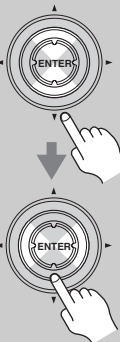

Use the Up and Down [▲]/[▼] buttons to select the settings and use the Left and Right [◀]/[▶] buttons to select them.

The HDMI settings are explained below.

### HDMI Audio Out

This preference determines whether audio received at the HDMI IN is output by the HDMI OUT. You may want to turn this preference on if your TV is connected to the HDMI OUT and you want to listen to the audio from a component that's connected to an HDMI IN, through your TV's speakers. Normally, this should be set to Off.

**Off:** HDMI audio is not output (default).

**On:** HDMI audio is output.

#### Notes:

- If On is selected and the signal can be output by the TV, the AV receiver/AV amplifier will output no sound through its speakers.
- When TV Control is enabled, this setting is set to Auto.
- With some TVs and input signals, no sound may be output even when this setting is set to On.

### Lip Sync

The AV receiver/AV amplifier can be set to automatically correct any delay between the video and the audio, based on the data from the connected monitor.

**Disable:** HDMI lip sync disabled.

**Enable:** HDMI lip sync enabled.

#### Notes:

- This function works only if your HDMI-compatible TV supports HDMI Lip Sync.
- You can check the amount of delay being applied by the HDMI Lip Sync function on the A/V Sync screen (see page 89).

### xvYCC

If you set the xvYCC color function to Enable while a source and monitor that both support the xvYCC color standard are connected to HDMI, the color quality will be improved.

**Disable:** xvYCC color disabled.

**Enable:** xvYCC color enabled.

#### Notes:

- If the color is unnatural when xvYCC color is set to Enable, change the setting to Disable.
- Refer to the connected component's instruction manual for details.

## Advanced Setup—Continued

### Control

This function allows CEC-standard-compatible equipment connected to HDMI and **RIHD**-compatible equipment to be operated together with the AV receiver/AV amplifier.

**Disable:** HDMI Control disabled.

**Enable:** HDMI Control enabled.

#### Notes:

- Set to Disable when a connected piece of equipment is not compatible or it is unclear whether the equipment is compatible or not.
- If movement is unnatural when set to Enable, change the setting to Disable.
- Refer to the connected component's instruction manual for details.

### ■ Power Control

To link the electrical connection of CEC-standard-compatible equipment and **RIHD**-compatible equipment by means of HDMI, set to Enable. However, it may not be possible to power link equipment, depending on the settings and compatibility of the connected equipment.

**Disable:** Power Control disabled.

**Enable:** Power Control enabled.

#### Notes:

- The Power Control setting can be set only when the above Control setting is set to Enable.
- HDMI power control only works with HDMI-compatible components that support it.
- When set to Enable, power consumption will increase. (North American models)
- The AV receiver/AV amplifier enters Ready mode when set to Standby. (not North American models)
- Refer to the connected component's instruction manual for details.

### ■ TV Control

Set to Enable when you want to control the AV receiver/AV amplifier from an **RIHD**-compatible TV that is connected to HDMI.

**Disable:** TV Control disabled.

**Enable:** TV Control enabled.

#### Notes:

- Set to Disable when the TV is not compatible or when it is unclear whether the TV is compatible or not.
- The TV Control setting can be set only when the above Control and Power Control settings are both set to Enable.
- Refer to the connected component's instruction manual for details.

#### Notes:

- After changing the settings of the Control, Power Control, or TV Control, turn off the power to all connected pieces of equipment and then turn on again. Refer to the User's Manuals for all connected pieces of equipment.
- When HDMI Audio Out is set to "On" or the TV Control is set to "Enable" and the audio is playing through the TV speakers, if the volume is adjusted on the AV receiver/AV amplifier, the audio will begin to play through the speakers connected to the AV receiver/AV amplifier. If you want to turn off the audio from the AV receiver/AV amplifier, repeat the set up operation, and the set up for the TV, or turn down the volume to its lowest level.

## Advanced Setup—Continued

### Lock Setup

**1**



Press the **[RECEIVER]** button followed by the **[SETUP]** button.

The main menu appears onscreen.

**2**

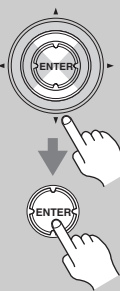

Use the Up and Down **[▲]/[▼]** buttons to select **"8. Lock Setup,"** and then press **[ENTER]**.

The Lock Setup menu appears.

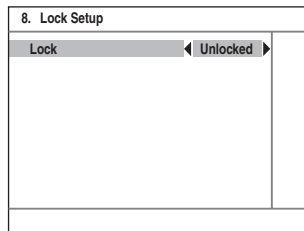

With this preference, you can protect your settings by locking the setup menus.

When the setup menus are locked, you cannot change any setting.

**Locked:** Setup menus locked.

**Unlocked:** Setup menus not locked.

### Digital Input Signal Formats

The digital input signal formats are available only for the input sources that you have assigned a digital input jack; otherwise you will see "Analog" indicated on the screen (see page 51).

Normally, the AV receiver/AV amplifier detects the signal format automatically. However, if you experience either of the following issues when playing PCM or DTS material, you can manually set the signal format to PCM or DTS:

- If the beginnings of tracks from a PCM source are cut off, try setting the format to PCM.
- If noise is produced when fast forwarding or reversing a DTS CD, try setting the format to DTS.

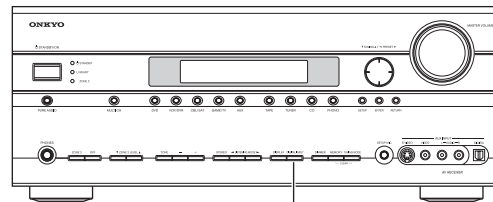

DIGITAL INPUT

**1**

Press and hold the AV receiver/AV amplifier's **[DIGITAL INPUT]** button for about 3 seconds.

**2**

While **"Auto"** is displayed (about 3 seconds), press the **[DIGITAL INPUT]** button again to select: **PCM, DTS, or Auto.**

**DTS or PCM:** The DTS or PCM indicator, depending on which format you have set, flashes, and only signals in that format are output. Digital signals in other formats are ignored.

**Auto (default):** The format is detected automatically. If no digital input signal is present, the corresponding analog input is used instead.

## Advanced Setup—Continued

### Changing the Remote Controller's ID

If several Onkyo components are used in the same room, the remote controller's control codes may overlap with those of another component. To differentiate the remote controller's control codes, you can change its ID to another number.

**Note:**

If you change the remote controller's ID, be sure to set the same ID on both the remote controller and AV receiver/AV amplifier (see "Changing the AV Receiver/AV Amplifier's ID" on page 94). The default ID for both is 1.

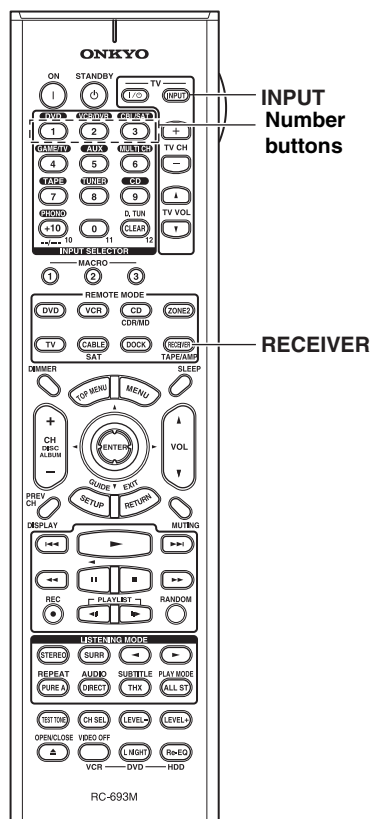

- 1** Hold down the [RECEIVER] and the TV [INPUT] buttons at the same time.

The Remote indicator flashes four times.

- 2** Use the number buttons to enter ID 1, 2, or 3.

The Remote indicator flashes twice.

## Zone 2

### Connecting Zone 2

With the Zone 2 function, you can enjoy one input source in the main room and a different source in another room.

There are two connection methods: using a receiver/integrated amp in Zone 2 or using only a pair of speakers in Zone 2.

#### Note:

For speaker connections and related cautions, see page 23.

### Using a Receiver/Integrated Amp in Zone 2

With this connection method, you can use 7.1 surround sound in the main room and play a different AV source in Zone 2. The volume for Zone 2 is set on the receiver/integrated amp.

- Use an RCA audio cable to connect the AV receiver/AV amplifier's ZONE 2 LINE OUT L/R jacks to an analog audio input on your receiver/integrated amp.
- Connect the Zone 2 speakers to the speaker terminals on the receiver/integrated amp.

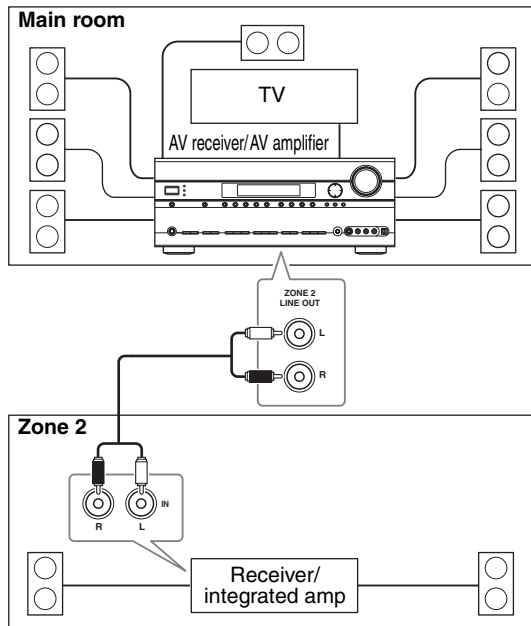

### Using Only Speakers in Zone 2

With this connection method, you can use 5.1 surround sound in the main room and play a different AV source in Zone 2. The volume for Zone 2 is set on the AV receiver/AV amplifier.

- Set the Powered Zone2 setting to "Act" (see page 100).
- Connect your Zone 2 speakers to the AV receiver/AV amplifier's ZONE 2 SPEAKERS terminals.

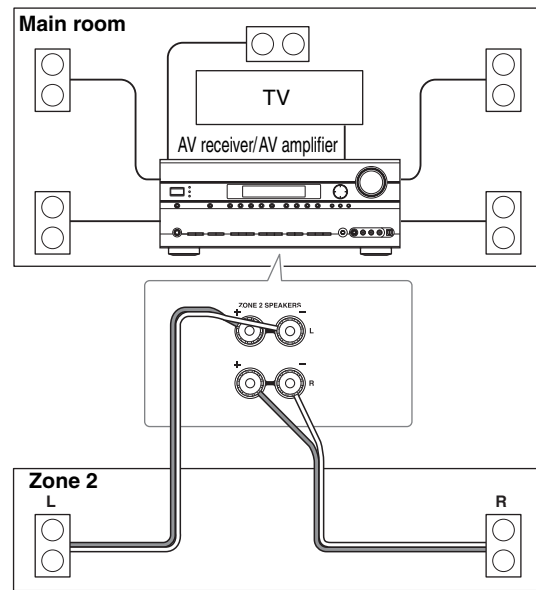

### Zone 2 12V Trigger

When Zone 2 is turned on, the output from the ZONE 2 12V TRIGGER OUT goes high (+12 volts, 100 milliamperes max). Connecting this jack to a 12-volt trigger input on a component in Zone 2 will make that component turn on or off as and when Zone 2 is turned on or off on the AV receiver/AV amplifier.

## Zone 2—Continued

### Setting the Powered Zone 2

To use Zone 2, you must make this setting. It enables the speakers connected to the ZONE 2 SPEAKERS terminals so that they produce sound when Zone 2 is used.

**1**



**Press the [RECEIVER] button followed by the [SETUP] button.**

The main menu appears onscreen.

**2**



**Use the Up and Down [▲]/[▼] buttons to select “7. Hardware Setup,” and then press [ENTER].**

The Hardware Setup menu appears.

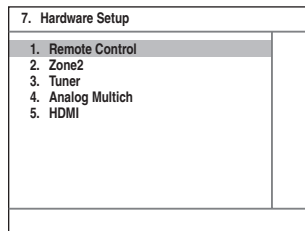

**3**

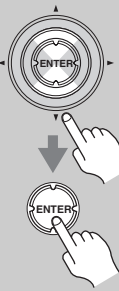

**Use the Up and Down [▲]/[▼] buttons to select “2. Zone2,” and then press [ENTER].**

The Zone2 menu appears.

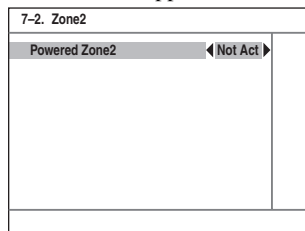

**4**



**Use the Left and Right [◀]/[▶] buttons to select:**

**Not Act:** ZONE 2 SPEAKERS terminals deactivated.

**Act:** ZONE 2 SPEAKERS terminals activated.

When Zone 2 is activated and turned on (see below), the speakers connected to the ZONE 2 SPEAKERS terminals output sound, but the speakers connected to the SURR BACK SPEAKERS terminals do not (when Zone 2 is activated but not used, the surround back speakers work as normal).

**5**



**Press the [SETUP] button.**

The setup menu closes.

**Note:**

This procedure can also be performed on the AV receiver/AV amplifier by using its [SETUP] button, arrow buttons, and [ENTER] button.

## Zone 2—Continued

### Using Zone 2

This section explains how to turn Zone 2 on and off, how to select an input source for Zone 2, and how to adjust the volume for Zone 2.

### Controlling Zone 2 from the AV receiver/AV amplifier

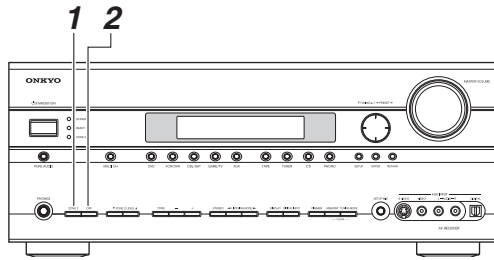

**1**



**To turn on Zone 2 and select an input source, press the [ZONE 2] button repeatedly.**

**Alternatively, press the [ZONE 2] button followed by an input selector button within 8 seconds.**

Zone 2 turns on, the ZONE 2 indicator lights up, and the ZONE 2 12V TRIGGER OUT goes high (+12 V).

To select AM or FM press the [TUNER] input selector button repeatedly (TX-SR705 only).

To select the same source as that of the main room, press the [ZONE 2] button repeatedly until “Z2 Sel: Source” appears.

**2**



**To turn off Zone 2, press the ZONE 2 [OFF] button.**

**Note:**

While Powered Zone 2 is being used, listening modes that require surround back speakers (6.1/7.1), such as Dolby Digital EX, DTS-ES, and THX Select2 Cinema, are unavailable.

### Controlling Zone 2 with the Remote Controller

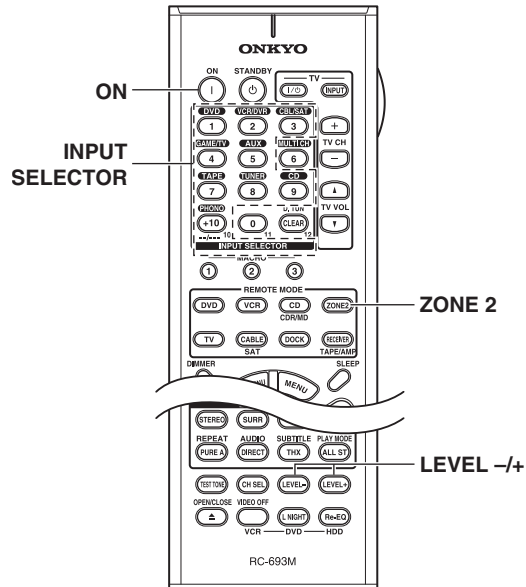

**Note:**

- To control Zone 2, you must press the remote controller's [ZONE 2] button first.

**1**

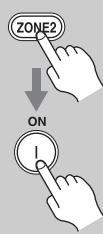

**Press the [ZONE 2] button, then point the remote controller at the AV receiver/AV amplifier and press the [ON] button.**

Zone 2 turns on, the ZONE 2 indicator lights up, and the ZONE 2 12V TRIGGER OUT goes high (+12 V).

**2**



**To select an input source for Zone 2, press the [ZONE 2] button, followed by an INPUT SELECTOR button.**

To select AM or FM press the [TUNER] INPUT SELECTOR button repeatedly.

**3**



**To turn off Zone 2, press the [ZONE 2] button, followed by the [STANDBY] button.**

## Zone 2—Continued

### Adjusting the Volume for Zone 2

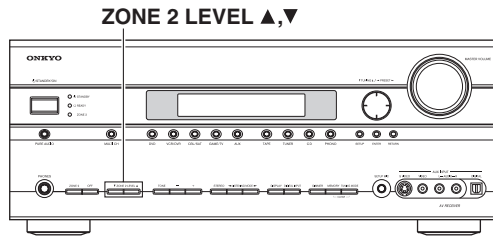

<p><b>Remote controller</b></p> <p><b>AV receiver/ AV amplifier</b></p>	<p><b>On the remote controller, press the [ZONE 2] button, and then use the [LEVEL-] and [LEVEL+] buttons.</b></p> <p><b>On the AV receiver/AV amplifier, use the ZONE 2 LEVEL [▲]/[▼] buttons.</b></p> <p>If your Zone 2 speakers are connected to a receiver or integrated amp in Zone 2, use its volume control to adjust the volume.</p>
---	--

#### To Mute Zone 2:

Press the remote controller's [ZONE 2] button, followed by the [MUTING] button. To unmute Zone 2, press the remote controller's [ZONE 2] button again, followed by the [MUTING] button, or adjust the volume for Zone 2.

#### Notes:

- Only analog input sources are output by the ZONE 2 LINE OUT and ZONE 2 SPEAKERS terminals. Digital input sources are not output. If no sound is heard when an input source is selected, check if it's connected to an analog input.
- While Zone 2 is being used, listening modes that need surround back speakers (i.e., Dolby Digital EX, DTS-ES, and THX Select2 Cinema) are unavailable.
- While Zone 2 is on, **RI** functions will not work.
- You can't select different radio stations for Zone 2 and the main room. For example, if you have an FM station for the main room, that station will also be used in Zone 2.

## Zone 2—Continued

### Using the Remote Controller in Zone 2 and Multiroom Control Kits

To control the AV receiver/AV amplifier with the remote controller while you're in the Zone 2 room, you'll need a commercially available multiroom remote control kit.

- Multiroom kits are made by Niles and Xantech.
- These kits can also be used when there isn't a clear line of sight to the AV receiver/AV amplifier's remote sensor, such as when it's installed inside a cabinet.

### Using a Multiroom Kit with Zone 2

In this setup, the IR receiver in Zone 2 picks up the infrared signals from the remote controller and feeds them through to the AV receiver/AV amplifier in the main room via the connecting block.

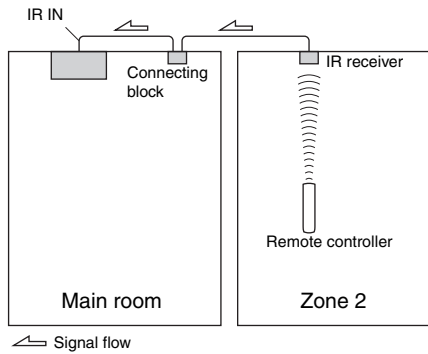

The miniplug cable from the connecting block should be connected to the AV receiver/AV amplifier's IR IN jack, as shown below.

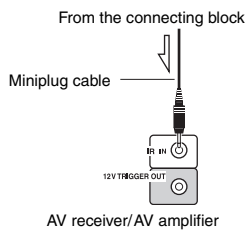

### Using a Multiroom Kit with a Cabinet

In this setup, the IR receiver picks up the infrared signals from the remote controller and feeds them to the AV receiver/AV amplifier located in the cabinet via the connecting block.

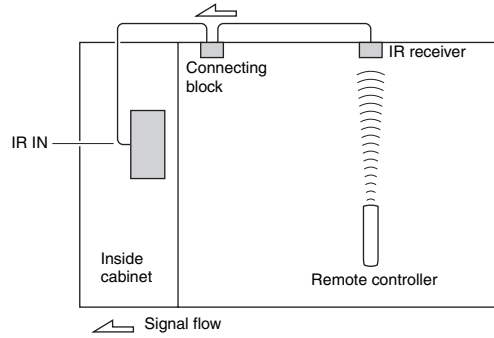

## Controlling Other Components

You can use the AV receiver/AV amplifier's remote controller (RC-693M) to control your other AV components, including those made by other manufacturers. This section explains how to:

- Enter the remote control code for a component that you want to control: DVD, TV, VCR, etc.
- Learn commands directly from another component's remote controller (see page 107).
- Program the MACRO buttons to perform a sequence of up to eight remote control actions (see page 108).

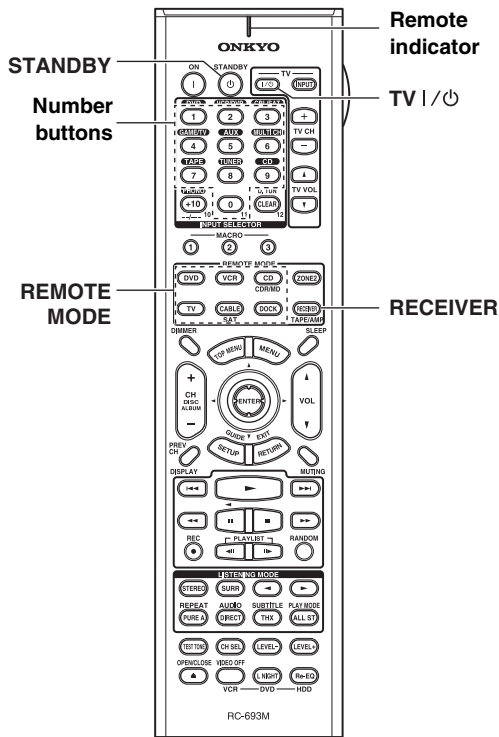

### Entering Remote Control Codes

To control another component, you must first enter the appropriate remote control code to a REMOTE MODE button. You'll need to enter a code for each component that you want to control.

**1**

**Look up the appropriate remote control code in the separate Remote Control Codes list.**

The codes are organized by category (e.g., DVD player, TV, etc.).

**2**

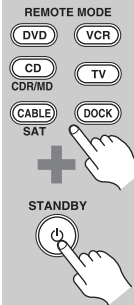

**While holding down the REMOTE MODE button that you want to set, press the [STANDBY] button.**

The Remote indicator lights up.

**3**

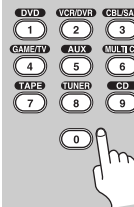

**Within 30 seconds, use the number buttons to enter the 4-digit remote control code.**

The Remote indicator flashes twice.

**4**

**Press the REMOTE MODE button again to select the remote controller mode, point the remote controller at the component, and check the operation.**

If the remote controller doesn't work as expected, and several remote codes are listed, try each one in turn and use the one that works best.

#### Notes:

- A remote control code cannot be entered for the [RECEIVER] button.
- The remote control codes provided are correct at the time of printing, but are subject to change.

- The DOCK remote mode can only be used with the Onkyo RI Dock at this time.
- The [DVD] and [CD] REMOTE MODE buttons are preprogrammed for use with Onkyo DVD players and CD players, respectively.
- To control another manufacturer's CD recorder or MD recorder, enter the appropriate remote control code to the [CD] REMOTE MODE button.

## Controlling Other Components—Continued

### Remote Control Codes for Onkyo Components Connected via RI

Onkyo components that are connected via **RI** are controlled by pointing the remote controller at the AV receiver/AV amplifier, not the component. This allows you to control components that are out of view, in a rack, for example.

- 1** Make sure the Onkyo component is connected with an **RI** cable and an analog audio cable (RCA).  
See page 43 for details.
- 2** Enter the appropriate remote control code for the [DVD] or [CD] REMOTE MODE button.
  - [DVD] REMOTE MODE button  
**5002:** Onkyo DVD player with **RI**
  - [CD] REMOTE MODE button  
**6002:** Onkyo CD player with **RI**
  - [MD] REMOTE MODE button  
**6008:** Onkyo MD recorder with **RI**
  - [CDR] REMOTE MODE button  
**6006:** Onkyo CD recorder with **RI**
  - [DOCK] REMOTE MODE button  
**6004:** Onkyo RI DOCK DS-A1 with **RI**

See the previous page for how to enter remote control codes.
- 3** Press the [DVD] or [CD] REMOTE MODE button, point the remote controller at the AV receiver/AV amplifier, and operate the component.

If you want to control an Onkyo component by pointing the remote controller directly at it, or you want to control an Onkyo component that's not connected via **RI**, use the following remote control codes:

- [DVD] REMOTE MODE button  
**5001:** Onkyo DVD player without **RI** (default)
- [CD] REMOTE MODE button  
**6001:** Onkyo CD player without **RI** (default)
- [MD] REMOTE MODE button  
**6007:** Onkyo MD recorder without **RI**
- [CDR] REMOTE MODE button  
**6005:** Onkyo CD recorder without **RI**
- [DOCK] REMOTE MODE button  
**6003:** Onkyo RI DOCK DS-A2 without **RI** (default)

#### Note:

If you connect an **RI**-capable Onkyo MiniDisc or CD recorder to the TAPE IN/OUT jacks, for remote operation to work properly, you must set the Input Display to MD or CDR, respectively (see page 50).

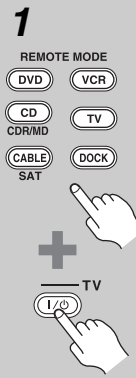
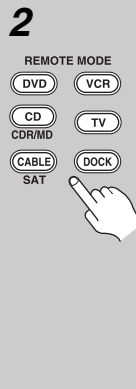

### Resetting REMOTE MODE Buttons

You can reset a REMOTE MODE button to its default remote control code.

- 1** While holding down the REMOTE MODE button that you want to reset, press the TV [I/⏻] button.  
The Remote indicator flashes three times.  

- 2** Press the REMOTE MODE button again.  
The Remote indicator flashes twice, indicating that the button has been reset.  
The [DVD] and [CD] REMOTE MODE buttons are preprogrammed with remote control codes for controlling Onkyo DVD players and CD players respectively. When these buttons are reset, the preprogrammed code is restored.  

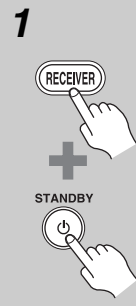
### Resetting the Remote Controller

You can reset the remote controller to its default settings.

- 1** While holding down the [RECEIVER] REMOTE MODE button, press the [STANDBY] button.  
The Remote indicator flashes five times.  

- 2** Press the [RECEIVER] REMOTE MODE button again.  
The Remote indicator flashes twice, indicating that the remote controller has been reset.  

## Controlling Other Components—Continued

To control another component, point the remote controller at it and use the buttons explained below. (You must select the appropriate remote control mode first.) With some AV components, certain buttons may not work as expected, and some may not work at all.

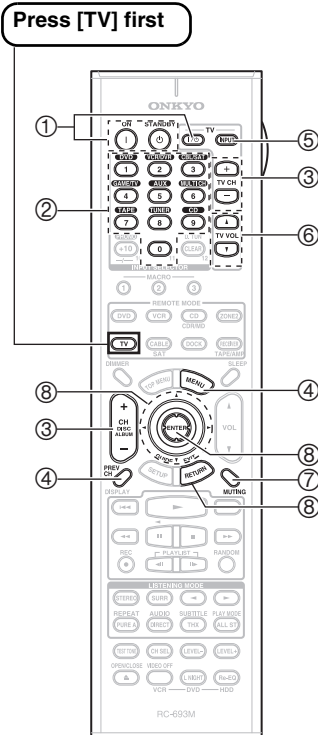
### ■ Controlling a TV



- ① **[ON], [STANDBY], TV** [I/⏻]\*  
Sets the TV to Standby or On.
- ② **Number buttons**  
Enter numbers.
- ③ **[CH +/-], TV CH [+]/[-]\***  
Selects channels on the TV.
- ④ **[PREV CH]**  
Selects the previous channel.
- ⑤ **[TV INPUT]\***  
Selects the TV's VCR input.
- ⑥ **TV VOL [▲]/[▼]\***  
Adjusts the TV's volume.
- ⑦ **[MUTING]**  
Mutes the TV.
- ⑧ **[▲]/[▼]/[◀]/[▶]/[MENU]/[ENTER]/[RETURN]**  
Navigate menus on the TV.

\* Buttons marked with an asterisk (\*) are exclusively for controlling a TV and can be used at anytime regardless of the current remote controller mode.

### ■ Controlling a VCR

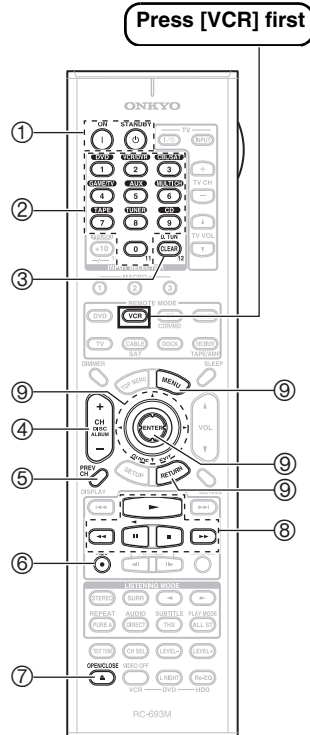

- ① **[ON], [STANDBY]**  
Sets the VCR to Standby or On.
- ② **Number buttons**  
Select channels.
- ③ **[CLEAR]**  
Cancels functions.
- ④ **[CH +/-]**  
Selects channels on the VCR.
- ⑤ **[PREV CH]**  
Selects the previous channel.
- ⑥ **REC [●]**  
Starts recording.
- ⑦ **Eject [▲]**  
Ejects the videocassette.
- ⑧ **[▶], [⏸], [■], [◀], [▶▶]**  
Play, Pause, Stop, Rewind, and Fast forward.
- ⑨ **[▲]/[▼]/[◀]/[▶]/[MENU]/[ENTER]/[RETURN]**  
Navigate menus on the VCR.

### ■ Controlling a Satellite or Cable Receiver

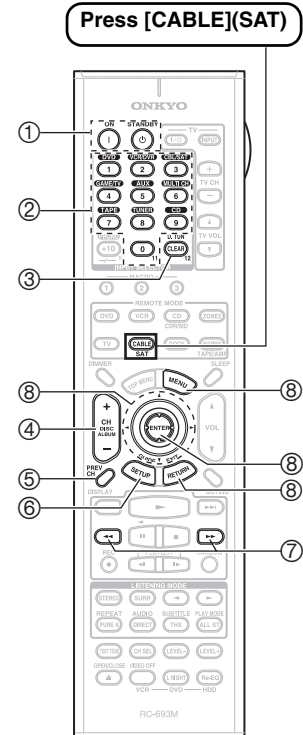

- ① **[ON], [STANDBY]**  
Sets the satellite/cable receiver to Standby or On.
- ② **Number buttons**  
Enter numbers.
- ③ **[CLEAR]**  
Cancels functions.
- ④ **[CH +/-]**  
Selects satellite/cable channels.
- ⑤ **[PREV CH]**  
Selects the previous channel.
- ⑥ **[GUIDE]**  
Displays the program guide.
- ⑦ **[◀], [▶▶]**  
Rewind and Fast forward.
- ⑧ **[▲]/[▼]/[◀]/[▶]/[MENU]/[ENTER]/[RETURN]**  
Navigate menus on the satellite/cable receiver.

## Controlling Other Components—Continued

### Learning Commands

The AV receiver/AV amplifier's remote controller can learn the commands of other remote controllers. By transmitting, for example, the Play command from your CD player's remote controller, the remote controller can learn it, and then transmit the exact same command when its Play [▶] button is pressed in the CD remote mode.

This is useful when you've entered the appropriate remote control code (page 104) but some buttons don't work as expected.

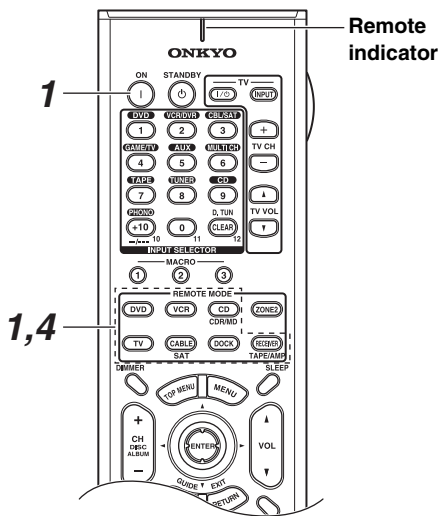

**3**

Point the remote controllers at each other, about 2 to 6 inches (5–15 cm) apart, and then press and hold the button whose command you want to learn until the Remote indicator flashes.

If the command is learned successfully, the Remote indicator flashes twice.

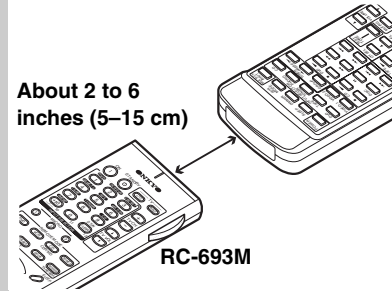

**4**

To learn more commands, repeat steps 2 and 3.

Press any REMOTE MODE button when you've finished.

**1**

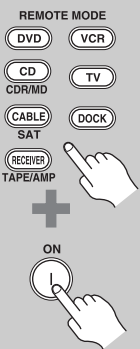

**While holding down the REMOTE MODE button for the mode in which you want to use the command, press the [ON] button.**

The Remote indicator lights up.

**2**

**Press the button you want to learn the new command.**

#### Notes:

- The following buttons cannot learn new commands: REMOTE MODE, MACRO [1], [2], [3], TV [I/⏻], TV [INPUT], TV CH [+]/[-], TV VOL [▲]/[▼], Light.
- The remote controller can learn approximately 70 to 90 commands, although this will be less if commands that use a lot of memory are learned.
- Remote controller buttons such as Play, Stop, Pause, and so on are preprogrammed with commands for controlling Onkyo CD players, cassette decks, and DVD players. However, they can learn new commands, and you can restore the preprogrammed commands at any time by resetting the remote controller (see page 105).
- To overwrite a previously learned command, repeat this procedure.
- Only commands from infrared remote controllers can be learned.
- When the remote controller's batteries expire, all learned commands will be lost and will have to be learned all over again, so don't discard your other remote controllers.

## Controlling Other Components—Continued

### Using Macros

You can program the remote controller's MACRO buttons to perform a sequence of remote control actions.

#### Example:

To play a CD you typically need to perform the following actions:

9. Press the [RECEIVER] REMOTE MODE button to select the Receiver remote controller mode.
10. Press the [ON] button to turn on the AV receiver/AV amplifier.
11. Press the [CD] INPUT SELECTOR button to select the CD input source.
12. Press the [CD] REMOTE MODE button to select the CD remote controller mode.
13. Press the Play [▶] button to start playback on the CD player.

You can program a MACRO button so that all five actions are performed with just one button press.

### Making Macros

Each MACRO button can store one macro, and each macro can contain up to eight commands.

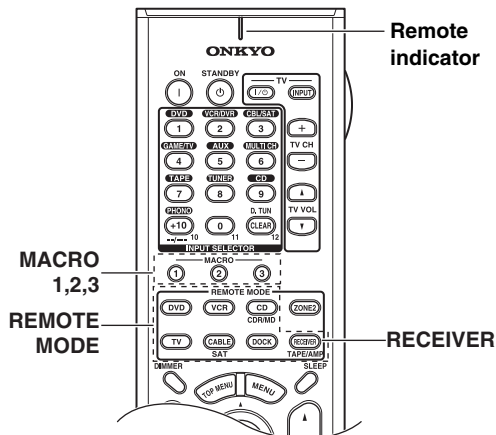

**1**

**While holding down the REMOTE MODE button of the remote controller mode you want to use at the start of the macro, press MACRO button [1], [2], or [3].**  
The Remote indicator lights up.

For the CD example above, you'd press and hold the [RECEIVER] REMOTE MODE button, and then press MACRO button [1], [2], or [3].

**2**

**Press the buttons whose actions you want to program into the macro in the order you want them performed.**

For the CD example in the left column, you'd press the following buttons: [ON], [CD] INPUT SELECTOR, [CD] REMOTE MODE, Play [▶].

**3**

**When you've finished, press the MACRO button again.**

The Remote indicator flashes twice.  
If you enter eight commands, the process will finish automatically.

#### Notes:

- If any of the buttons you used to make a macro are taught new commands, the macro will no longer work properly and will have to be made again.

### Running Macros

**Press the MACRO [1], [2], or [3] button.**

The commands in the macro are transmitted in the order in which they were programmed. Keep the remote controller pointed at the AV receiver/AV amplifier until all of the commands have been transmitted.

Macros can be run at any time, regardless of the current remote controller mode.

### Deleting Macros

**1**

**While holding down the [RECEIVER] REMOTE MODE button, press the MACRO button whose macro you want to delete.**  
The Remote indicator lights up.

**2**

**Press the MACRO button again.**  
The Remote indicator flashes twice.

# Specifications

## Amplifier Section

Rated Output Power (FTC)	
<b>All channels:</b>	<b>100 watts minimum continuous power per channel, 8 ohm loads, 2 channels driven from 20 Hz to 20 kHz, with a maximum total harmonic distortion of 0.08%</b>
	<b>115 watts minimum continuous power per channel, 8 ohm loads, 2 channels driven at 1 kHz, with a maximum total harmonic distortion of 0.7%</b>
	<b>125 watts minimum continuous power per channel, 6 ohm loads, 2 channels driven at 1 kHz with a maximum total harmonic distortion of 0.1%</b>
Rated Output Power (IEC)	7 ch × 160 W at 6 ohms, 1 kHz, 1 ch driven
Maximum Output Power (JEITA)	7 ch × 190 W at 6 ohms, 1 kHz, 1 ch driven
Dynamic Power	240 W + 240 W (3 Ω, Front) 210 W + 210 W (4 Ω, Front) 120 W + 120 W (8 Ω, Front)
THD (Total Harmonic Distortion)	0.08% (Power Rated) 0.08% (1 kHz, 1 W)
Damping Factor	60 (Front, 1 kHz, 8 Ω)
Input Sensitivity and Impedance	200 mV/47 kΩ (LINE) 2.5 mV/47 kΩ (PHONO MM)
Phono Overload	70 mV (MM 1 kHz, 0.5%)
Output Level and Impedance	200 mV/470 Ω (REC OUT)
Frequency Response	5 Hz - 100 kHz/+1 dB - 3 dB (Direct mode)
Tone Control	±10 dB, 50 Hz (BASS) ±10 dB, 20 kHz (TREBLE)
Signal to Noise Ratio	106 dB (LINE, IHF-A) 80 dB (PHONO, IHF-A)
Speaker Impedance	4 Ω - or 6 Ω - 16 Ω

## Video Section

Input Sensitivity/Output Level and Impedance	1 V <sub>p-p</sub> /75 Ω (Component and S-Video Y) 0.7 V <sub>p-p</sub> /75 Ω (Component P <sub>B</sub> /C <sub>B</sub> , Pr/C <sub>R</sub> ) 0.28 V <sub>p-p</sub> /75 Ω (S-Video C) 1 V <sub>p-p</sub> /75 Ω (Composite)
Component Video Frequency Response	5 Hz - 50 MHz - 3 dB

## Tuner Section (TX-SR705 only)

FM Tuning Frequency Range	North American: 87.5 MHz - 107.9 MHz Others: 87.5 MHz - 108.0 MHz
AM Tuning Frequency Range	North American: 530 kHz - 1710 kHz European: 522 kHz - 1611 kHz Others: 522/530 kHz - 1611/1710 kHz
Preset Channel	40
Digital Tuner (North American models only):	XM, SIRIUS

## General

Power Supply	North American: AC 120 V, 60 Hz European: AC 220 - 240 V, 50/60 Hz Others: AC 220 - 240 V, 50/60 Hz AC 120 V, 60 Hz
Power Consumption	North American: 6.2 A European: 600 W Others: 600 W
Dimensions (W × H × D)	435 × 174 × 377 mm 17-1/8" × 6-7/8" × 14-13/16"
Weight	North American: 12.9 kg (28.4 lbs.) Others: 12.8 kg (28.2 lbs.) 12.7 kg (28.0 lbs.)

### Video Inputs

HDMI	IN1, IN2, IN3
Component	IN1, IN2, IN3
S-Video	DVD, VCR/DVR, CBL/SAT, GAME/TV, AUX
Composite	DVD, VCR/DVR, CBL/SAT, GAME/TV, AUX

### Video Outputs

HDMI	OUT
Component	OUT
S-Video	MONITOR OUT, VCR/DVR
Composite	MONITOR OUT, VCR/DVR

### Audio Inputs

Digital Inputs	Optical: 2 (Rear), 1 (Front) Coaxial: 3
Analog Inputs	DVD (MULTICHANNEL), VCR/DVR, CBL/SAT, GAME/TV, AUX, TAPE, CD, PHONO
Multichannel Inputs	7.1

### Audio Outputs

Digital Outputs	Optical: 1
Analog Outputs	TAPE, VCR/DVR, ZONE2
Multichannel Pre Outputs	7
Subwoofer Pre Output	1
Speaker Outputs	FL, FR, C, SL, SR, SBL, SBR, ZONE2 (L/R)
Phones	1

### Control Terminal

MIC	Yes
RS232	1
IR Input	1
12 V Trigger Out	ZONE2

Specifications and features are subject to change without notice.

## Troubleshooting

If you have any trouble using the AV receiver/AV amplifier, look for a solution in this section. If you can't resolve the issue yourself, contact your Onkyo dealer.

If you can't resolve the issue yourself, try resetting the AV receiver/AV amplifier before contacting your Onkyo dealer.

**To reset the AV receiver/AV amplifier to its factory defaults, turn it on and, while holding down the [VCR/DVR] button, press the [STANDBY/ON] button. "Clear" will appear on the display and the AV receiver/AV amplifier will enter Standby mode.**



Note that resetting the AV receiver/AV amplifier will delete your radio presets and custom settings.

### Power

#### Can't turn on the AV receiver/AV amplifier

- Make sure that the power cord is properly plugged into the wall outlet.
- Unplug the power cord from the wall outlet, wait five seconds or more, then plug it in again.

#### The AV receiver/AV amplifier turns off as soon as it's turned on

- The amp protection circuit has been activated. Remove the power cord from the wall outlet immediately. Disconnect all speaker cables and input sources, and leave the AV receiver/AV amplifier with its power cord disconnected for 1 hour. After that, reconnect the power cord and set the volume to maximum. If the AV receiver/AV amplifier stays on, set the volume to minimum, disconnect the power cord, and reconnect your speakers and input sources. If the AV receiver/AV amplifier turns off when you set the volume to maximum, disconnect the power cord, and contact your Onkyo dealer.

### Audio

#### There's no sound, or it's very quiet

- Make sure that the digital input source is selected properly (page 51). Press the [DIGITAL INPUT] button repeatedly.
- Make sure that all audio connecting plugs are pushed in all the way (page 21).
- Make sure that the inputs and outputs of all components are connected properly (page 29-42).
- Make sure that the polarity of the speaker cables is correct, and that the bare wires are in contact with the metal part of each speaker terminal (page 23).
- Make sure that the input source is properly selected (page 59).

- Make sure that the speaker cables are not shorting.
- Check the volume. It can be set to  $-\infty$  dB,  $-81$  dB through  $+17$ ,  $+18$  dB (page 59). The AV receiver/AV amplifier is designed for home theater enjoyment. It has a wide volume range, allowing precise adjustment.
- If the MUTING indicator is shown on the display, press the remote controller's [MUTING] button to unmute the AV receiver/AV amplifier (page 61).
- While a pair of headphones is connected to the PHONES jack, no sound is output by the speakers (page 61).
- If there's no sound from a DVD player connected to an HDMI IN, check the DVD player's output settings, and be sure to select a supported audio format.
- Check the digital audio output setting on the connected device. On some game consoles, such as those that support DVD, the default setting is off.
- With some DVD-Video discs, you need to select an audio output format from a menu.
- If your turntable doesn't have a built-in phono preamp, you must connect one between it and the AV receiver/AV amplifier. If your turntable uses an MC cartridge, you must connect an MC head amp, or an MC transformer and phono equalizer.
- Make sure that none of the connecting cables are bent, twisted, or damaged.
- Not all listening modes use all speakers (page 71).
- Specify the speaker distances (page 80) and adjust the individual speaker levels (page 81).
- Make sure that the speaker setup microphone is not still connected.
- The input signal format is set to PCM or DTS. Set it to Auto (page 97).

#### Only the front speakers produce sound

- When the Stereo listening mode is selected, only the front speakers and subwoofer produce sound.
- In the Mono listening mode, only the front speakers output sound if the Output Speaker setting is set to L/R (page 85).
- Check the Speaker Configuration (page 77).

#### Only the center speaker produces sound

- If you use the Dolby Pro Logic IIx Movie, Dolby Pro Logic IIx Music, or Dolby Pro Logic IIx Game listening mode with a mono source, such as an AM radio station or mono TV program, the sound is concentrated in the center speaker.
- Make sure the speakers are configured correctly (page 77).

## Troubleshooting—Continued

### The surround speakers produce no sound

- When the Stereo or Mono listening mode is selected, the surround speakers produce no sound (page 71).
- Depending on the source and current listening mode, not much sound may be produced by the surround speakers. Try selecting another listening mode.
- Make sure the speakers are configured correctly (page 77).

### The center speaker produces no sound

- When the Mono or Stereo listening mode is selected, the center speaker produces no sound (page 71).
- Make sure the speakers are configured correctly (page 77).

### The surround back speakers produce no sound

- The surround back speakers are not used with all listening modes. Select another listening mode (page 71).
- Not much sound may be produced by the surround back speakers with some sources.
- Make sure the speakers are configured correctly (page 77).

### The subwoofer produces no sound

- When you play source material that contains no information in the LFE channel, the subwoofer produces no sound.
- Make sure the speakers are configured correctly (page 77).

### There's no sound with a certain signal format

- Check the digital audio output setting on the connected device. On some game consoles, such as those that support DVD, the default setting is off.
- With some DVD-Video discs, you need to select an audio output format from a menu.
- Depending on the input signal, some listening modes cannot be selected (pages 67-70).

### Can't select the DTS-ES Discrete/Matrix listening modes

- These modes cannot be selected when no surround back speakers are connected, or the Zone 2 speakers are being used.
- You can not always select all of the listening modes, depending on the number of the speaker connected (pages 67-70).

### Can't get 6.1/7.1 playback

- If no surround back speakers are connected, or the Zone 2 speakers are being used, 6.1/7.1 playback is not possible.
- You can not always select all of the listening modes, depending on the number of the speakers connected (pages 67-70).

### The volume cannot be set to +18 dB (99)

- Check to see if a maximum volume has been set (page 92).
- After the Automatic Speaker Setup function has been run, or the volume level of each individual speaker has been adjusted (page 81), the maximum volume may be reduced.

### Noise can be heard

- Using cable ties to bundle audio cables with power cords, speaker cables, and so on may degrade the audio performance, so don't do it.
- An audio cable may be picking up interference. Try repositioning your cables.

### The Late Night function doesn't work

- Make sure the source material is Dolby Digital, Dolby Digital Plus, and Dolby TrueHD (page 75).

### The DVD analog multichannel input doesn't work

- Check the DVD analog multichannel input connections (page 31).
- To select the DVD analog multichannel input, press the [MULTI CH] input selector button.
- Check the audio output settings on your DVD player.

### About DTS signals

- When DTS program material ends and the DTS bit-stream stops, the AV receiver/AV amplifier remains in DTS listening mode and the DTS indicator remains on. This is to prevent noise when you use the pause, fast forward, or fast reverse function on your player. If you switch your player from DTS to PCM, because the AV receiver/AV amplifier does not switch formats immediately, you may not hear any sound, in which case you should stop your player for about three seconds, and then resume playback.
- With some CD and LD players, you won't be able to playback DTS material properly even though your player is connected to a digital input on the AV receiver/AV amplifier. This is usually because the DTS bitstream has been processed (e.g., output level, sampling rate, or frequency response changed) and the AV receiver/AV amplifier doesn't recognize it as a genuine DTS signal. In such cases, you may hear noise.
- When playing DTS program material, using the pause, fast forward, or fast reverse function on your player may produce a short audible noise. This is not a malfunction.

### The beginning of audio received by an HDMI IN can't be heard

- Since it takes longer to identify the format of an HDMI signal than it does for other digital audio signals, audio output may not start immediately.

## Troubleshooting—Continued

### Video

#### There's no picture

- Make sure that all video connecting plugs are pushed in all the way (page 21).
- Make sure that each video component is properly connected. (pages 29-42)
- If your TV is connected to the HDMI OUT, set the HDMI Monitor setting to Yes (page 47), and select "--" in the "HDMI Input Setup" on page 48 to watch composite video, S-Video, and component video sources.
- If your TV is connected to the COMPONENT VIDEO OUT, set the HDMI Monitor setting to No (page 47), and select "--" in the "Component Video Setup" on page 49 to watch composite video and S-Video sources.
- If the video source is connected to a component video input, your TV must be connected to the COMPONENT VIDEO OUT or HDMI OUT (page 27 and 28).
- If the video source is connected to an HDMI input, your TV must be connected to the HDMI OUT (page 27).
- While the Pure Audio listening mode is selected, the video circuitry is turned off and only video signals input through HDMI IN can be output.
- On your TV, make sure that the video input to which the AV receiver/AV amplifier is connected is selected.

#### There's no picture from a source connected to an HDMI IN

- If the message "Resolution Error" appears on the AV receiver/AV amplifier's display, this indicates that the TV or display does not support the current video resolution and you need to select another resolution on your DVD player.

#### The onscreen menus don't appear

- The onscreen menus may do not appear on a TV that's connected to the HDMI OUT. When the HDMI Monitor is set to No (page 47), the onscreen menus are output at a resolution of 480i. If the onscreen menus do not appear, set the HDMI Monitor to Yes (page 47).
- Make sure that the video settings are correct (page 48 and 49).
- On your TV, make sure that the video input to which the AV receiver/AV amplifier is connected is selected.

#### The immediate display does not appear

- The immediate display appears on a device connected to the COMPONENT VIDEO OUT, when the Component Video Setup (page 49) is set to "--."
- If both of the HDMI Input Setup (page 48) and the Component Video Setup (page 49) are set to "--," the immediate display is output to a device connected to the HDMI OUT.

### Tuner (TX-SR705 only)

#### Reception is noisy, FM stereo reception is noisy, or the FM STEREO indicator doesn't appear

- Relocate your antenna.
- Move the AV receiver away from your TV or computer.
- Listen to the station in mono (page 62).
- When listening to an AM station, operating the remote controller may cause noise.
- Passing cars and airplanes can cause interference.
- Concrete walls weaken radio signals.
- If nothing improves the reception, install an outdoor antenna.

### Remote Controller

#### The remote controller doesn't work

- Make sure that the batteries are installed with the correct polarity (page 14).
- Install new batteries. Don't mix different types of batteries, or old and new batteries (page 14).
- Make sure that the remote controller is not too far away from the AV receiver/AV amplifier, and that there's no obstruction between the remote controller and the AV receiver/AV amplifier's remote control sensor (page 14).
- Make sure that the AV receiver/AV amplifier is not subjected to direct sunshine or inverter-type fluorescent lights. Relocate if necessary.
- If the AV receiver/AV amplifier is installed in a rack or cabinet with colored-glass doors, the remote controller may not work reliably when the doors are closed.
- Make sure you've selected the correct remote controller mode (pages 15-19).
- When using the remote controller to control other manufacturers' AV components, some buttons may not work as expected.
- Make sure you've entered the correct remote control code.
- Make sure to set the same ID on both the AV receiver/AV amplifier and remote controller (pages 94 and 98).

## Troubleshooting—Continued

### Can't control other components

- If it's an Onkyo component, make sure that the **RI** cable and analog audio cable are connected properly. Connecting only an **RI** cable won't work (page 43).
- Make sure you've selected the correct remote controller mode (pages 15-19).
- If you've connected an **RI**-capable Onkyo MD recorder, CD recorder, **RI** Dock to the TAPE IN/OUT jacks, or an **RI** Dock to the GAME/TV IN jacks, for the remote controller to work properly, you must set the display to MD, CDR, or DOCK (page 50).

When operating a DS-A1 RI Dock, enter the appropriate remote control code for the first time (page 104).

- To control another manufacturer's component, point the remote controller at that component.
- To control an Onkyo component that's connected via **RI**, point the remote controller at the AV receiver/AV amplifier. Be sure to enter the appropriate remote control code first (page 105).
- To control an Onkyo component that's not connected via **RI**, or another manufacturer's component, point the remote controller at the component. Be sure to enter the appropriate remote control code first (page 104).

### Recording

#### Can't record

- On your recorder, make sure the correct input is selected (e.g., digital or analog).
- When the Pure Audio listening mode is selected, recording is not possible because no video signals are output. Select another listening mode.

### Zone 2

#### There's no sound

- Only components connected to analog inputs can be played in Zone 2.

### Others

#### The sound changes when I connect my headphones

- When a pair of headphones is connected, the listening mode is set to Stereo, unless it's already set to Stereo, Mono, Direct, or Pure Audio.

#### The speaker volume cannot be set as required

- When the Automatic Speaker Setup function is used, or the volume is adjusted on the onscreen setup menus, the maximum possible volume setting may change.

#### The speaker distance cannot be set as required

- In some cases, corrected values suitable for home theater use may be set automatically.

### The display doesn't work

- The display is turned off when the Pure Audio (not North American models) listening mode is selected.

### How do I change the language of a multiplex source

- Use the "Multiplex" setting on the "Audio Adjust" menu to select Main or Sub (page 85).

### The RI functions don't work

- To use **RI**, you must make an **RI** connection and an analog audio connection (RCA) between the component and AV receiver/AV amplifier, even if they are connected digitally (page 43).

### The functions Auto Power On/Standby and Direct Change don't work for components connected via RI

- These functions don't work when Zone 2 is turned on.

### When performing "Automatic Speaker Setup," the measurement fails showing the message "Ambient noise is too high."

- This can be caused by any malfunction in your speaker unit. Check if the unit produces normal sounds.

### The following settings can be made for the S-Video and composite video inputs

You must use the buttons on the unit to make these settings.

1. While holding down the input selector button for the input source that you want to set, press the [SETUP] button.
2. Use the Left and Right [◀]/[▶] buttons to change the setting.
3. Press the [SETUP] button when you've finished.

#### Video Attenuation

This setting can be made for the DVD, VCR/DVR, CBL/SAT, GAME/TV, or AUX input.

If you have a games console connected to the S-Video or composite video input, and the picture isn't very clear, you can attenuate the gain.

**Video ATT:0:** (default).

**Video ATT:2:** Gain is reduced by 2 dB.

The AV receiver/AV amplifier contains a microcomputer for signal processing and control functions. In very rare situations, severe interference, noise from an external source, or static electricity may cause it to lockup. In the unlikely event that this happens, unplug the power cord from the wall outlet, wait at least five seconds, and then plug it back in again.

Onkyo is not responsible for damages (such as CD rental fees) due to unsuccessful recordings caused by the unit's malfunction. Before you record important data, make sure that the material will be recorded correctly.

Before disconnecting the power cord from the wall outlet, set the AV receiver/AV amplifier to Standby.

# Memo

---

---

# Memo

---

---

## **ONKYO CORPORATION**

Sales & Product Planning Div. : 2-1, Nisshin-cho, Neyagawa-shi, OSAKA 572-8540, JAPAN  
Tel: 072-831-8023 Fax: 072-831-8124

### **ONKYO U.S.A. CORPORATION**

18 Park Way, Upper Saddle River, N.J. 07458, U.S.A.  
Tel: 201-785-2600 Fax: 201-785-2650 <http://www.us.onkyo.com/>

### **ONKYO EUROPE ELECTRONICS GmbH**

Liegnitzerstrasse 6, 82194 Groebenzell, GERMANY  
Tel: +49-8142-4401-0 Fax: +49-8142-4401-555 <http://www.eu.onkyo.com/>

### **ONKYO EUROPE UK Office**

Suite 1, Gregories Court, Gregories Road, Beaconsfield, Buckinghamshire, HP9 1HQ  
UNITED KINGDOM Tel: +44-(0)1494-681515 Fax: +44(0)-1494-680452

### **ONKYO CHINA LIMITED**

Unit 1 & 12, 9/F, Ever Gain Plaza Tower 1, 88, Container Port Road, Kwai Chung,  
N.T., Hong Kong Tel: 852-2429-3118 Fax: 852-2428-9039  
<http://www.ch.onkyo.com/>



Y0705-1

SN 29344476

(C) Copyright 2007 ONKYO CORPORATION Japan. All rights reserved.



\* 2 9 3 4 4 4 7 6 \*