

SONY®

3-098-548-11(1)

Digital Video Camera Recorder

HANDYCAM®

Operating Guide

DCR-SR42/SR62/SR82/SR200/SR300

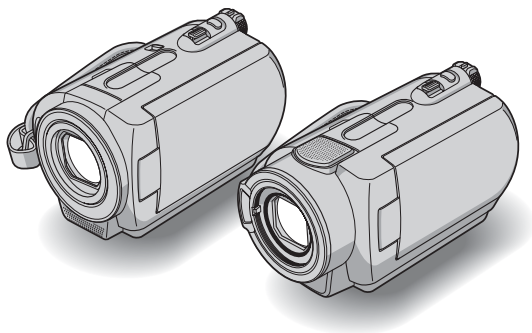

For details on the advanced operations, please refer to "Handycam Handbook" (PDF).



WARNING

To reduce fire or shock hazard, do not expose the unit to rain or moisture.

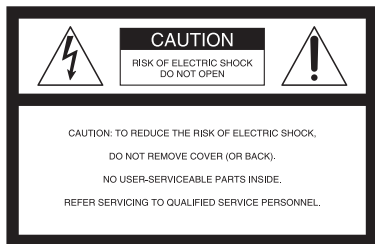

This symbol is intended to alert the user to the presence of uninsulated “dangerous voltage” within the product’s enclosure that may be of sufficient magnitude to constitute a risk of electric shock to persons.



This symbol is intended to alert the user to the presence of important operating and maintenance (servicing) instructions in the literature accompanying the appliance.

IMPORTANT SAFEGUARDS

For your protection, please read these safety instructions completely before operating the appliance, and keep this manual for future reference.

Carefully observe all warnings, precautions and instructions on the appliance, or the one described in the operating instructions and adhere to them.

Use

Power Sources

This set should be operated only from the type of power source indicated on the marking label. If you are not sure of the type of electrical power supplied to your home, consult your dealer or local power company. For those sets designed to operate from battery power, or other sources, refer to the operating instructions.

Polarization

This set may be equipped with a polarized ac power cord plug (a plug having one blade wider than the other).

This plug will fit into the power outlet only one way. This is a safety feature. If you are unable to insert the plug fully into the outlet, try reversing the plug. If the plug should still fail to fit, contact your electrician to have a suitable outlet installed. Do not defeat the safety purpose of the polarized plug by forcing it in.

Overloading

Do not overload wall outlets, extension cords or convenience receptacles beyond their capacity, since this can result in fire or electric shock.

Object and Liquid Entry

Never push objects of any kind into the set through openings as they may touch dangerous voltage points or short out parts that could result in a fire or electric shock. Never spill liquid of any kind on the set.

Attachments

Do not use attachments not recommended by the manufacturer, as they may cause hazards.

Cleaning

Unplug the set from the wall outlet before cleaning or polishing it. Do not use liquid cleaners or aerosol cleaners. Use a cloth lightly dampened with water for cleaning the exterior of the set.

Installation

Water and Moisture

Do not use power-line operated sets near water – for example, near a bathtub, washbowl, kitchen sink, or laundry tub, in a wet basement, or near a swimming pool, etc.

Power-Cord Protection

Route the power cord so that it is not likely to be walked on or pinched by items placed upon or against them, paying particular attention to the plugs, receptacles, and the point where the cord exits from the appliance.

Accessories

Do not place the set on an unstable cart, stand, tripod, bracket, or table. The set may fall, causing serious injury to a child or an adult, and serious damage to the set. Use only a cart, stand, tripod, bracket, or table recommended by the manufacturer.

Ventilation

The slots and openings in the cabinet are provided for necessary ventilation. To ensure reliable operation of the set, and to protect it from overheating, these slots and openings must never be blocked or covered.

- Never cover the slots and openings with a cloth or other materials.
- Never block the slots and openings by placing the set on a bed, sofa, rug, or other similar surface.
- Never place the set in a confined space, such as a bookcase, or built-in cabinet, unless proper ventilation is provided.
- Do not place the set near or over a radiator or heat register, or where it is exposed to direct sunlight.

Lightning

For added protection for this set during a lightning storm, or when it is left unattended and unused for

long periods of time, unplug it from the wall outlet and disconnect the antenna or cable system. This will prevent damage to the set due to lightning and power-line surges.

Service

Damage Requiring Service

Unplug the set from the wall outlet and refer servicing to qualified service personnel under the following conditions:

- When the power cord or plug is damaged or frayed.
- If liquid has been spilled or objects have fallen into the set.
- If the set has been exposed to rain or water.
- If the set has been subject to excessive shock by being dropped, or the cabinet has been damaged.
- If the set does not operate normally when following the operating instructions. Adjust only those controls that are specified in the operating instructions. Improper adjustment of other controls may result in damage and will often require extensive work by a qualified technician to restore the set to normal operation.
- When the set exhibits a distinct change in performance – this indicates a need for service.

Servicing

Do not attempt to service the set yourself as opening or removing covers may expose you to dangerous voltage or other hazards.

Refer all servicing to qualified service personnel.

Replacement parts

When replacement parts are required, be sure the service technician has used replacement parts specified by the manufacturer that have the same characteristics as the original parts.

Unauthorized substitutions may result in fire, electric shock, or other hazards.

Safety Check

Upon completion of any service or repairs to the set, ask the service technician to perform routine safety checks (as specified by the manufacturer) to determine that the set is in safe operating condition.

Read this first

Before operating the unit, please read this manual thoroughly, and retain it for future reference.

CAUTION

Replace the battery with the specified type only. Otherwise, fire or injury may result.

For customers in the U.S.A. and CANADA

RECYCLING LITHIUM-ION BATTERIES

Lithium-Ion batteries are recyclable.

You can help preserve our environment by returning your used rechargeable batteries to the collection and recycling location nearest you.

For more information regarding recycling of rechargeable batteries, call toll free 1-800-822-8837, or visit <http://www.rbrcc.org/>



Caution: Do not handle damaged or leaking Lithium-Ion batteries.

Owner's Record

The model and serial numbers are located on the bottom. Record the serial number in the space provided below. Refer to these numbers whenever you call your Sony dealer regarding this product.

Model No. DCR- _____

Serial No. _____

Model No. AC- _____

Serial No. _____

For customers in the U.S.A.

If you have any questions about this product, you may call:
Sony Customer Information Center 1-800-222-SONY (7669).
The number below is for the FCC related matters only.

Regulatory Information

Declaration of Conformity

Trade Name: SONY

Model No.: DCR-SR42

Responsible Party: Sony Electronics Inc.

Address: 16530 Via Esprillo, San Diego, CA 92127 U.S.A

Telephone number: 858-942-2230

This device complies with Part 15 of the FCC Rules.

Operation is subject to the following two conditions:

(1) This device may not cause harmful interference, and (2) this device must accept any interference received, including interference that may cause undesired operation.

Declaration of Conformity

Trade Name: SONY

Model No.: DCR-SR62

Responsible Party: Sony Electronics Inc.

Address: 16530 Via Esprillo, San Diego, CA 92127 U.S.A

Telephone number: 858-942-2230

This device complies with Part 15 of the FCC Rules.

Operation is subject to the following two conditions:

(1) This device may not cause harmful interference, and (2) this device must accept any interference received, including interference that may cause undesired operation.

Declaration of Conformity

Trade Name: SONY
Model No.: DCR-SR82
Responsible Party: Sony Electronics Inc.
Address: 16530 Via Esprillo, San Diego, CA
92127 U.S.A
Telephone number: 858-942-2230
This device complies with Part 15 of the FCC
Rules.
Operation is subject to the following two
conditions:
(1) This device may not cause harmful
interference, and (2) this device must accept any
interference received, including interference
that may cause undesired operation.

Declaration of Conformity

Trade Name: SONY
Model No.: DCR-SR200
Responsible Party: Sony Electronics Inc.
Address: 16530 Via Esprillo, San Diego, CA
92127 U.S.A
Telephone number: 858-942-2230
This device complies with Part 15 of the FCC
Rules.
Operation is subject to the following two
conditions:
(1) This device may not cause harmful
interference, and (2) this device must accept any
interference received, including interference
that may cause undesired operation.

Declaration of Conformity

Trade Name: SONY
Model No.: DCR-SR300
Responsible Party: Sony Electronics Inc.
Address: 16530 Via Esprillo, San Diego, CA
92127 U.S.A
Telephone number: 858-942-2230
This device complies with Part 15 of the FCC
Rules.
Operation is subject to the following two
conditions:
(1) This device may not cause harmful
interference, and (2) this device must accept any
interference received, including interference
that may cause undesired operation.

Notes

DCR-SR42, DCR-SR62, DCR-SR82, DCR-SR200
and DCR-SR300 are to be used with the Handycam
Station Model DCRA-C171 and AC Adaptor
Model AC-L200/L200B.

CAUTION

You are cautioned that any changes or
modifications not expressly approved in this
manual could void your authority to operate this
equipment.

Note

This equipment has been tested and found to
comply with the limits for a Class B digital
device, pursuant to Part 15 of the FCC Rules.
These limits are designed to provide reasonable
protection against harmful interference in a
residential installation. This equipment generates,
uses, and can radiate radio frequency energy and,
if not installed and used in accordance with the
instructions, may cause harmful interference to
radio communications.
However, there is no guarantee that interference
will not occur in a particular installation. If this
equipment does cause harmful interference to
radio or television reception, which can be
determined by turning the equipment off and on,
the user is encouraged to try to correct the
interference by one or more of the following
measures:

- Reorient or relocate the receiving antenna.
- Increase the separation between the equipment
and receiver.
- Connect the equipment into an outlet on a
circuit different from that to which the receiver
is connected.
- Consult the dealer or an experienced radio/TV
technician for help.

The supplied interface cable must be used with
the equipment in order to comply with the limits for a
digital device pursuant to Subpart B of Part 15 of
FCC Rules.

For the State of California, USA only

Perchlorate Material - special handling may
apply, See

www.dtsc.ca.gov/hazardouswaste/perchlorate

Perchlorate Material: Lithium battery contains
perchlorate.

For customers in the U.S.A. and CANADA

Battery pack

This device complies with Part 15 of the FCC Rules. Operation is subject to the following two conditions:

(1) This device may not cause harmful interference, and (2) this device must accept any interference received, including interference that may cause undesired operation.

This Class B digital apparatus complies with Canadian ICES-003.

Notes on use

- The camcorder is not dustproofed, dripproofed or waterproofed. See "Precautions" (p.34).
- To prevent the hard disk from being broken or recorded images from being lost, do not do the following when either of the respective lamps of the POWER switch (p.13) or the access lamp* is on:
 - to remove the battery pack or AC Adaptor from the camcorder.
 - to apply mechanical shock or vibration to the camcorder.

On recording

- Before starting to record, test the recording function to make sure the image and sound are recorded without any problems.
- Compensation for the contents of recordings cannot be provided, even if recording or playback is not possible due to a malfunction of the camcorder, recording media, etc.
- TV color systems differ depending on the countries/regions. To view your recordings on a TV, you need a NTSC system-based TV.
- Television programs, films, video tapes, and other materials may be copyrighted. Unauthorized recording of such materials may be contrary to the copyright laws.

Save all your recorded image data

- To prevent your image data from being lost, save all your recorded images on external media. It is recommended that you save the image data on a disc such as DVD-R using your computer*. Also, you can save your image data using a VCR, or a DVD/HDD recorder*.
- It is recommended that you save your image data periodically, after recording.

Do not apply shock or vibration to your camcorder

- The hard disk of the camcorder may not be recognized, or recording or playback may not be possible.

On the drop sensor

- To protect the internal hard disk from the shock by dropping, the camcorder has the drop sensor function*. When a drop occurs, or under a non-gravity condition, the block noise to protect the camcorder may also be recorded. If the drop sensor catches a drop repeatedly, recording/playback may be stopped.

Note on operational temperatures

- When the temperature of the camcorder becomes extremely high or extremely low, you may not be able to record or play back on the camcorder, due to the protection features of the camcorder being activated in such situations. In this case, an indicator appears on the LCD screen (p.32).

When the camcorder is connected to a computer

- Do not try to format the hard disk of the camcorder using a computer. If you do so, your camcorder may not operate correctly.

Note on using the camcorder at high altitudes

- Do not turn on the camcorder in a low-pressure area, where the altitude is more than 3,000 meters (9,800 feet). Doing so may damage the hard disk drive of your camcorder.

Note on disposal/transfer

- If you perform [⊖ FORMAT]* or formatting the hard disk of the camcorder, you may not delete data from the hard disk completely. When you transfer the camcorder, it is recommended that you perform [⊖ EMPTY]* to prevent the recovery of your data.
In addition to the above, when you dispose of the camcorder, it is recommended that you destroy the actual body of the camcorder.

About language setting

- The on-screen displays in each local language are used for illustrating the operating procedures. Change the screen language before using your camcorder if necessary (p.13).

About this manual

- The LCD screens and indicators shown in this manual were taken with a digital still camera, and may look different from what you actually see.
- Design and specifications of recording media and other accessories are subject to change without notice.
- Unless otherwise specially indicated, illustrations in this manual are based on DCR-SR300.
- The screenshots are from Windows XP. The scenes may vary depending on the operating system of the computer.

* Refer to "Handycam Handbook" (PDF).



Table of Contents

IMPORTANT SAFEGUARDS	2
Read this first	4
Notes on use	7

Getting Started

Step 1: Checking supplied items.....	9
Step 2: Charging the battery pack	11
Step 3: Turning the power on, and setting the date and time	13
Changing the language setting	13
Step 4: Preparing for recording.....	14

Recording/Playback

Recording.....	15
Playback	17
Parts and functions used for the camcorder	19
Indicators displayed during recording/playback	22
Saving images	24
Deleting images	24
Playing the image on a TV.....	25
Performing with a computer.....	26
Performing various functions - “  HOME” and “  OPTION”	28

Troubleshooting

Troubleshooting	31
Warning indicators	32

Additional Information

Precautions	34
Specifications.....	35

Step 1: Checking supplied items

Make sure that you have the following items supplied with your camcorder. The number in the parentheses indicates the number of that item supplied.

AC Adaptor (1) (p.11)

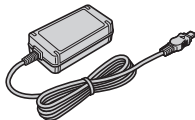

Power cord (1) (p.11)



Handycam Station (1) (p.11)

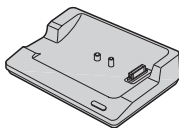

A/V connecting cable (1) (p.25)



USB cable (1) (p.27)

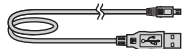

Wireless Remote Commander (1)
(except for DCR-SR42)



A button-type lithium battery is already installed.

Rechargeable battery pack
NP-FH40 (1) (p.11) (DCR-SR42/SR62/
SR82)

NP-FH60 (1) (p.11) (DCR-SR200/SR300)

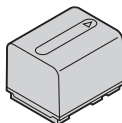

CD-ROM "Handycam Application
Software" (1) (p.26)

- Picture Motion Browser (Software)
- Handycam Handbook (PDF)

"Operating Guide" (This manual) (1)

Power supply

You can use your camcorder in any countries/regions using the AC Adaptor supplied with your camcorder within the AC 100 V to 240 V, 50/60 Hz range.

Use a commercially available AC plug adaptor [a], if necessary, depending on the design of the wall outlet [b].

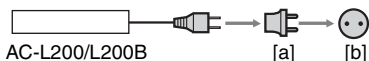

On the Remote Commander (except for DCR-SR42)

Using the Remote Commander for the first time

Remove the insulation sheet before using the Remote Commander.

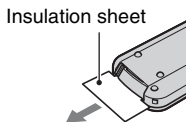

To change the battery of the Remote Commander

- ① While pressing on the tab, inset your fingernail into the slit to pull out the battery case.
- ② Place a new battery with the + side facing up.
- ③ Insert the battery case back into the Remote Commander until it clicks.

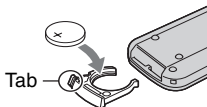

WARNING

Battery may explode if mistreated. Do not recharge, disassemble or dispose of in fire.

- When the lithium battery becomes weak, the operating distance of the Remote Commander may shorten, or the Remote Commander may not function properly. In this case, replace the battery with a Sony CR2025 lithium battery. Use of another battery may present a risk of fire or explosion.

Step 2: Charging the battery pack

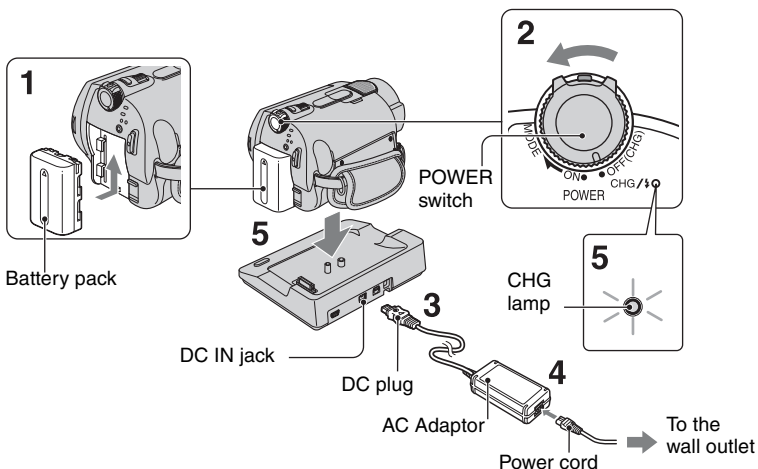

You can charge the “InfoLITHIUM” battery pack (H series) after attaching it to your camcorder.

- Your camcorder operates only with an “InfoLITHIUM” battery pack (H series).

1 Attach the battery pack by sliding it in the direction of the arrow until it clicks.

2 Turn the POWER switch in the direction of the arrow to OFF (CHG) (The default setting).

3 Connect the AC Adaptor to the DC IN jack on the Handycam Station.

Be sure that the ▲ mark on the DC plug is facing up.

4 Connect the power cord to the AC Adaptor and the wall outlet.



5 Set the camcorder onto the Handycam Station securely.

The CHG (charge) lamp lights up and charging starts. The CHG (charge) lamp turns off when the battery pack is fully charged. Remove the camcorder from the Handycam Station.

To remove the battery pack

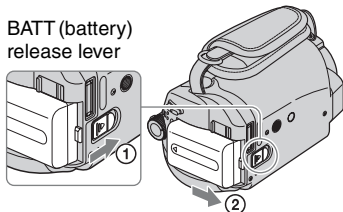
Turn the POWER switch to OFF (CHG). Slide the BATT (battery) release lever and remove the battery pack.



- When you remove the battery pack or the AC Adaptor, make sure that the  (Movie) lamp/  (Still) lamp (p.13) is turned off.

To charge the battery pack using only the AC Adaptor

Turn the POWER switch to OFF (CHG), then connect the AC Adaptor directly to the DC IN jack on the camcorder.

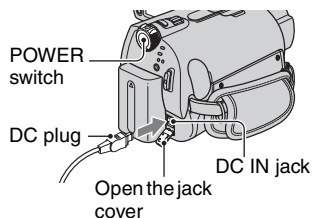

Available running time for the supplied battery pack

Charging time:

Approximate time (min.) required when you fully charge a completely exhausted battery pack.

Recording/Playback time:

Approximate time (min.) available when you use a fully charged battery pack.

NP-FH40: (Unit:min.)

	DCR-SR42	DCR-SR62/ SR82
Charging time	125	125
Recording time* ¹		
Continuous recording time	105	90* ² 100* ³
Typical recording time* ⁴	50	45* ² 50* ³
Playback time	120	110* ²

NP-FH60: (Unit:min.)

	DCR-SR200	DCR-SR300
Charging time	135	135
Recording time* ¹		
Continuous recording time	115* ² 120* ³	95* ² 100* ³
Typical recording time* ⁴	55* ² 60* ³	45* ² 50* ³
Playback time* ²	165	160

*¹ When [REC MODE] is set to [SP].

*² When the LCD backlight turns on.

*³ When the LCD backlight turns off.

*⁴ Typical recording time shows the time when you repeat recording start/stop, turning the power on/off and zooming.

On the battery pack

- Before changing the battery pack, turn the POWER switch to OFF (CHG) and turn off the (Movie) lamp (Still) lamp (p.13).
- The power will not be supplied from the battery as long as the AC Adaptor is connected to the DC IN jack of your camcorder or the Handycam Station, even when the power cord is disconnected from the wall outlet.

On the charging/recording/playback time

- Times measured when using the camcorder at 25°C (77°F) (10°C to 30°C (50°F to 86°F) is recommended).
- The available recording and playback time will be shorter when you use your camcorder in low temperatures.
- The available recording and playback time will be shorter depending on the conditions under which you use your camcorder.

On the AC Adaptor

- Use the nearby wall outlet when using the AC Adaptor. Disconnect the AC Adaptor from the wall outlet immediately if any malfunction occurs while using your camcorder.
- Do not use the AC Adaptor placed in a narrow space, such as between a wall and furniture.
- Do not short-circuit the DC plug of the AC Adaptor or battery terminal with any metallic objects. This may cause a malfunction.
- Even if your camcorder is turned off, AC power (house current) is still supplied to it while connected to the wall outlet via the AC Adaptor.

Step 3: Turning the power on, and setting the date and time

Touch the button on the LCD screen.

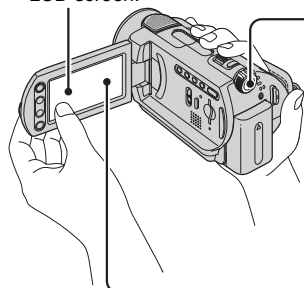

POWER switch

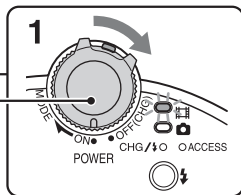

When using the camcorder for the first time, the [CLOCK SET] screen appears on the LCD screen.



1 While pressing the green button, turn the POWER switch repeatedly in the direction of the arrow until the respective lamp lights up.

When you record or play back an image, turn the POWER switch in the direction of the arrow repeatedly until the respective lamp lights up.

(Movie): To record movies

(Still): To record still images

- When you turn on (Still) lamp, the screen aspect ratio is changed to 4:3 automatically.

2 Select the desired geographical area with ▲/▼, then touch [NEXT].

3 Set [DST SET] or [SUMMERTIME], [Y] (year), [M] (month), [D] (day), hour and minute.



The clock starts.

- The date and time does not appear during recording, but they are automatically recorded on the hard disc, and can be displayed during playback.

To reset the date and time

Touch (HOME) → (SETTINGS) → [CLOCK/▲LANG] → [CLOCK SET], and set the date and time.

Changing the language setting

You can change the on-screen displays to show messages in a specified language.

Touch (HOME) → (SETTINGS) → [CLOCK/▲LANG] → [▲LANGUAGE SET], then select the desired language.

Step 4: Preparing for recording

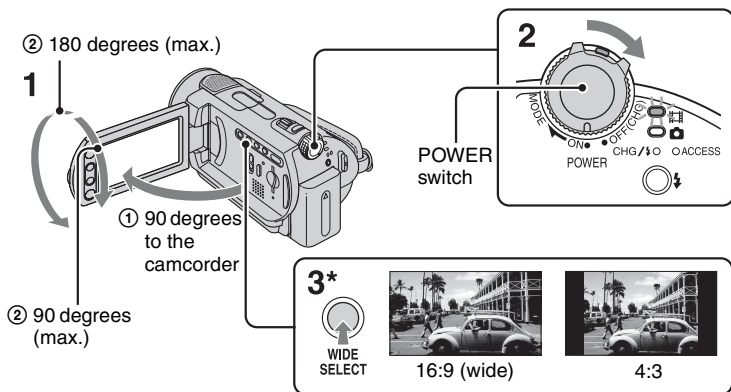

* Except for DCR-SR42.

1 Adjust the LCD panel.

Open the LCD panel 90 degrees to the camcorder (①), then rotate it to the best angle to record or play (②).

2 Turn the POWER switch to turn on your camcorder.

3 Press WIDE SELECT repeatedly to select the desired screen aspect ratio (except for DCR-SR42).

4 Fasten the grip belt and hold your camcorder correctly.

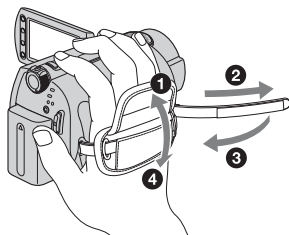

Recording

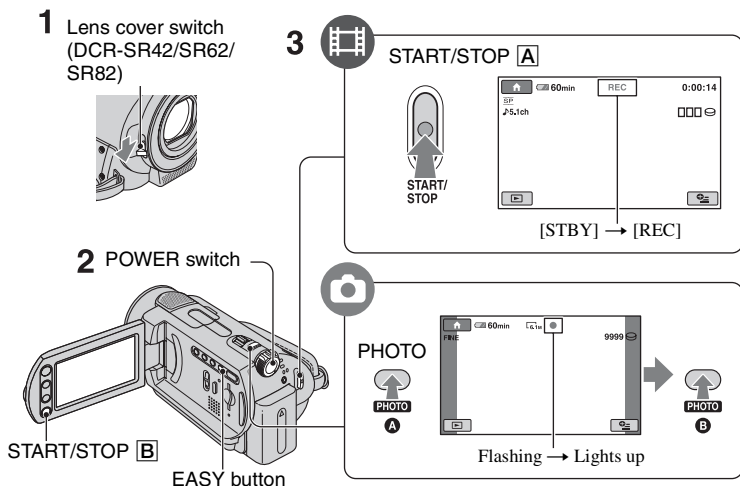

1 Slide the lens cover switch to open (DCR-SR42/SR62/SR82).

- For DCR-SR200/SR300, the lens cover opens and closes automatically.

2 Turn the POWER switch until the respective lamp lights up.

Press the green button only when the POWER switch is in the OFF (CHG) position.

- (Movie): To record movies
- (Still): To record still images

3 Start recording.

Movies

Press START/STOP [A] (or [B]).



To stop recording, press START/STOP again.

Still Images

Press PHOTO lightly to adjust the focus **A** (a beep sounds), then press it fully **B** (a shutter click sounds).

When disappears, the image has been recorded.

- Still images are recorded on the hard disk in the default setting.

- You can check the free hard disk space by touching  (HOME) →  (MANAGE HDD/MEMORY) →  [INFO].
- If the ACCESS lamp is lit or flashing after recording is finished, it means data is still being written onto the hard disk or “Memory Stick Duo.” Do not apply shock or vibration to your camcorder, and do not remove the battery or AC Adaptor.
- You can capture up to 3 still images by pressing PHOTO during movie recording (DCR-SR200/SR300).
- The maximum continuous recordable time is approximately 13 hours.
- When a movie file exceeds 2 GB, the next movie file is created automatically.
- The maximum recordable time are followings (with recording mode [SP]);
DCR-SR42/SR62:
approx. 10 hours and 50 minutes
DCR-SR82:
approx. 21 hours and 40 minutes
DCR-SR200/SR300:
approx. 14 hours and 30 minutes

To record still images on a “Memory Stick Duo”

You can change the recording media of still images to a “Memory Stick Duo.”

You can use only a “Memory Stick Duo” marked with MEMORY STICK DUO or MEMORY STICK PRO DUO.

■ Inserting/ejecting a “Memory Stick Duo”

Open the LCD panel, then insert the “Memory Stick Duo” into the Memory Stick Duo slot in the right direction until it clicks.

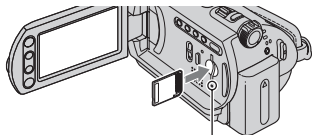



ACCESS lamp
 (“Memory Stick Duo”)

To eject a “Memory Stick Duo,” open the LCD panel, lightly push the “Memory Stick Duo” in once.

- When the ACCESS lamp is lit or flashing, your camcorder is reading/writing data. Do not shake or knock your camcorder, turn the power off, eject the “Memory Stick Duo,” or remove the battery pack. Otherwise, image data may be damaged.
- If you insert the “Memory Stick Duo” into the slot in the wrong direction, the “Memory Stick Duo,” the “Memory Stick Duo” slot, or image data may be damaged.
- The numbers of recordable still images on the “Memory Stick Duo” (1GB) are followings (with the default setting of the image size as shown in ());
DCR-SR42: 5,900 ([VGA (0.3M)])
DCR-SR62/SR82: 1,800 ([1.0M])
DCR-SR200: 480 ([4.0M])
DCR-SR300: 315 ([6.1M])
- All numbers measured when using a “Memory Stick Duo” made by Sony Corporation. The number of recordable images varies depending on the recording environment.
- The number of recordable images varies depending on the image quality or the image size. For details, see “Handycam Handbook” (PDF).

■ To change the recording media of still images

- ① Touch  (OPTION) →  tab → [STILL MEDIA].
- ② Select the media in which you want to save still images, then touch [OK].
Your camcorder returns to recording standby mode.

On Easy Handycam operation

By pressing the EASY button, nearly all settings on the camcorder will be automatically operated so that you can perform recording or playing back operation without detailed settings. During Easy Handycam operation, **EASY** appears on the LCD screen. To cancel Easy Handycam operation, press EASY again.

- You cannot use some buttons/functions during Easy Handycam operation.

Playback

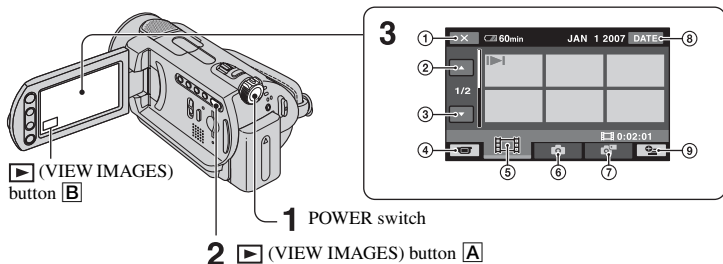

- ① Returns to the recording screen
- ② Previous 6 images
- ③ Next 6 images
- ④ Returns to the recording screen
- ⑤ Displays movies
- ⑥ Displays still images on the hard disk
- ⑦ Displays still images on a "Memory Stick Duo"
- ⑧ Searches for images by date
- ⑨ (OPTION)

1 Turn the **POWER** switch to turn on your camcorder.

2 Press (**VIEW IMAGES**) **[A]** (or **[B]**) button.

The **VISUAL INDEX** screen appears on the LCD screen. (It may take some time to display the thumbnails.)

3 Start playback.

Movies



Touch the tab, and the movie to be played back.

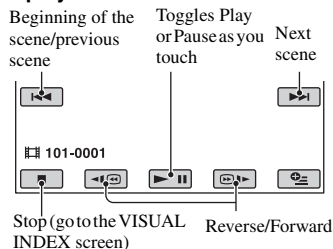





Still Images

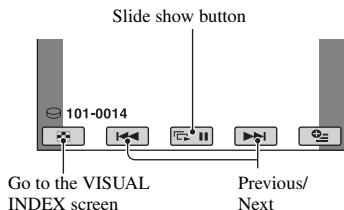







Touch the , or tab, and the still image to be played back.



To adjust the sound volume of movies

When playing back a movie, touch  (OPTION) →  tab → [VOLUME], then adjust the volume with  / .

- When playback from the selected movie reaches the last movie, the screen returns to the VISUAL INDEX screen.
- Touch  /  during pause to play back movie slowly.
- One touch of  /  makes the reverse/fast forward approximately 5 times faster, 2 touches makes it approximately 10 times faster, 3 touches makes it approximately 30 times faster, and 4 touches makes it approximately 60 times faster.
-  appears with the image on each of the tab that was lastly played back/recorded ( for the still image) last time. When you touch a movie marked with , you can play it back from the point you have stopped previously.

Parts and functions used for the camcorder

DCR-SR42/SR62/SR82

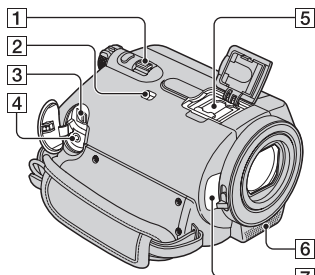

DCR-SR200/SR300

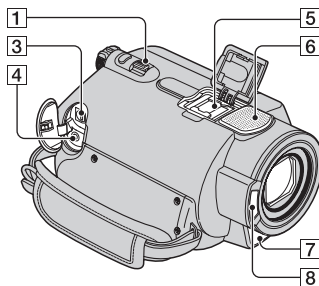

DCR-SR42/SR62/SR82

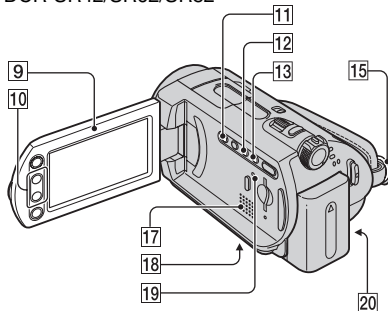

DCR-SR200/SR300

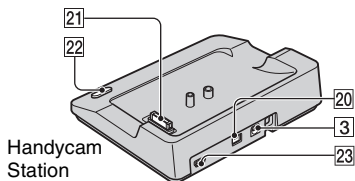
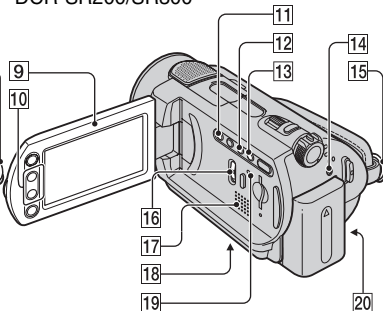

Handycam Station

Recording

1 Power zoom lever

To use zoom, move the power zoom lever. Move the power zoom lever slightly for a slower zoom. Move it further for a faster zoom.

2 NIGHTSHOT PLUS switch*1

To record in dark places, set the NIGHTSHOT PLUS switch to ON. ( appears.)

6 Built-in microphone

Records sound.
Sound picked up by the built-in microphone is converted to 5.1ch surround sound and recorded.*2

7 Remote sensor*3

Receive the signal from the Remote Commander.

8 Flash*2

Flashes when using the flash.

9 LCD screen

To record in mirror mode, open the LCD screen 90 degrees to the camcorder (1), then rotate it 180 degrees to the lens side (2).

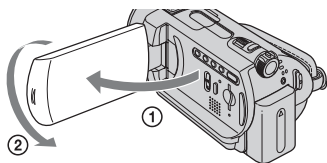

10 Zoom buttons

Press for zooming in/out.

11 BACK LIGHT button*4

To adjust the exposure for backlit subjects, press BACK LIGHT to display . To cancel the back light function, press BACK LIGHT again.

12 DISP/BATT INFO button

You can switch the screen display when you press while the power is set to on. When you press while the power is set to OFF (CHG), you can check the remaining battery.

13 EASY button

See page 16.

14 ⚡ (flash) button*2

You can select the settings for the flash.

15 Shoulder belt hook

Attach the shoulder belt (optional).

16 NIGHTSHOT switch*2

To record in dark places, set the NIGHTSHOT switch to ON. ( appears.)

18 Tripod receptacle (Bottom surface)

Attach the tripod (optional: the length of the screw must be less than 5.5 mm (7/32 in.)) to the tripod receptacle using a tripod screw.

19 RESET button

To initialize the settings (Reset), press RESET to initialize all the settings, including settings for date and time.

Playback

1 Power zoom lever

10 Zoom buttons

You can magnify still images from about 1.1 to 5 times the original size (Playback zoom).

- When you touch the screen during playback zoom, the point you touched will be displayed in the center of the displayed frame.

13 EASY button

See page 16.

17 Speaker

Sound comes out from the speaker while playing back.

Connecting to other devices

3 A/V OUT jack

Connect with the A/V connecting cable.

4 REMOTE jack*3

Connect other optional accessories.

5 Active Interface Shoe *3

The Active Interface Shoe supplies power to optional accessories such as a video light, a flash, or a microphone. The accessory can be turned on or off as you operate the POWER switch on your camcorder.

20 DC IN jack

21 Interface connector

22 DISC BURN button

Create a DVD by connecting the camcorder to a computer. For details, see “Handycam Handbook” (PDF).

23 (USB) jack

Connect with the USB cable.

*1 DCR-SR42/SR62/SR82

*2 DCR-SR200/SR300

*3 Except for DCR-SR42

*4 For DCR-SR42, the position of the buttons differ from the illustration.

Indicators displayed during recording/playback

Recording movies

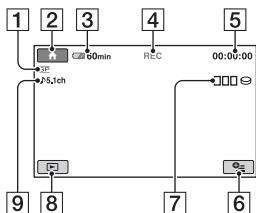

Viewing movies

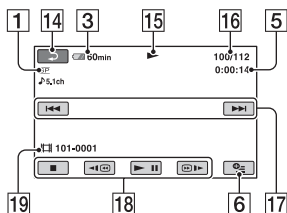

- 1** Recording mode (HQ / SP / LP)
- 2** HOME button
- 3** Remaining battery (approx.)
- 4** Recording status ([STBY] (standby) or [REC] (recording))
- 5** Counter (hour/minute/second)
- 6** OPTION button
- 7** Dual Rec (DCR-SR200/SR300)
- 8** VIEW IMAGES button
- 9** 5.1ch surround recording (DCR-SR200/SR300)

- 10** Quality ([FINE] / [STD])
- 11** Image size

- 12** Appears while a still image is being saved.

Recording still images

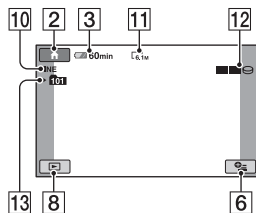

Viewing still images

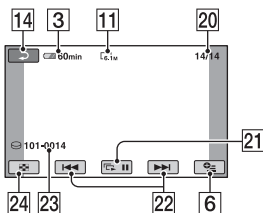

- 13** Recording folder
Displays only during the recording media of still images is a "Memory Stick Duo."

- 14** Return button
- 15** Playback mode
- 16** Current movie number/Number of total movies
- 17** Previous/Next button
- 18** Video operation buttons
- 19** Data file name

- 20** Current still image number/Number of recorded still images
- 21** Slide show button
- 22** Previous/Next button
- 23** Data file name
- 24** VISUAL INDEX button

Indicators when you made changes

Following indicators appear during recording/playback to indicate the settings of your camcorder.

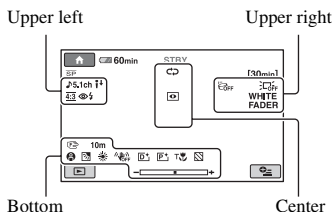

Upper left

Indicator	Meaning
	5.1ch surround recording/playback*1
	Self-timer recording
	Flash
	MICREF LEVEL low
	WIDE SELECT*2
	WIDE SELECT*3

Upper right

Indicator	Meaning
	FADER
	LCD backlight off
	Drop sensor off
	Drop sensor activated

Center

Indicator	Meaning
	Slide show set
	NightShot plus*4 NightShot*1
	Super NightShot plus*4 Super NightShot*1
	Color Slow Shutter

Indicator	Meaning
	PictBridge connecting
	Warning

Bottom

Indicator	Meaning
	Picture effect
	Digital effect
	Manual focus
	SCENE SELECTION
	Backlight
	White balance
	SteadyShot off
	EXPOSURE/ SPOT METER
	TELE MACRO
	ZEBRA*1

*1 DCR-SR200/SR300

*2 DCR-SR42

*3 DCR-SR62/SR82/SR200/SR300

*4 DCR-SR42/SR62/SR82

- The recording date and time is recorded automatically on the hard disk and "Memory Stick Duo." They are not displayed while recording. However, you can check them as [DATA CODE] during playback.

Saving images

Recorded images are stored on the internal hard disk of your camcorder. Due to the limited capacity of the internal hard disk, make sure that you save the image data to some type of external media such as a DVD-R or a computer.

You can save the images recorded on the camcorder as described below.

Saving images using a computer

By using the software on the supplied CD-ROM, you can save images on a DVD or the hard disk of a computer. For details, see “Handycam Handbook” (PDF).

Creating a DVD with One Touch (One Touch Disc Burn)

You can save images recorded on the camcorder directly to a DVD with ease.

Saving images on a computer

You can save images recorded on the camcorder on the hard disk of a computer.

Creating a DVD with selected images



You can save images imported to your computer on a DVD. You can also edit those images.

Saving images by connecting your camcorder to other devices



You can dub images to VCR or DVD/HDD devices. For details, see “Handycam Handbook” (PDF).

Deleting images



Deleting the images on the hard disk

1 On the  (HOME MENU), touch  (OTHERS) → [DELETE].

2 Touch  [DELETE].

3 Touch  [DELETE] (movies) or  [DELETE] (still images), according to the type of image you want to delete, then touch the image to be deleted.

The selected image is marked with ✓.

4 Touch  [OK] → [YES] →  [OK].

To delete all movies or still images at one time

In step **3**, touch  [DELETE ALL] or  [DELETE ALL] → [YES] → [YES] →  [OK].



To delete the still images in the “Memory Stick Duo”

① In step **2**, touch  [DELETE].

② Touch  [DELETE], then touch the still image to be deleted.

The selected still image is marked with ✓.

③ Touch  [OK] → [YES] →  [OK].

• To delete all still images on the “Memory Stick Duo,” in step **2**, touch  [DELETE ALL] → [YES] → [YES] →  [OK].

Playing the image on a TV

Connect your camcorder to the input jack of TV or VCR using A/V connecting cable **1** (supplied) or A/V connecting cable with S VIDEO **2** (optional). For details, see “Handycam Handbook” (PDF).

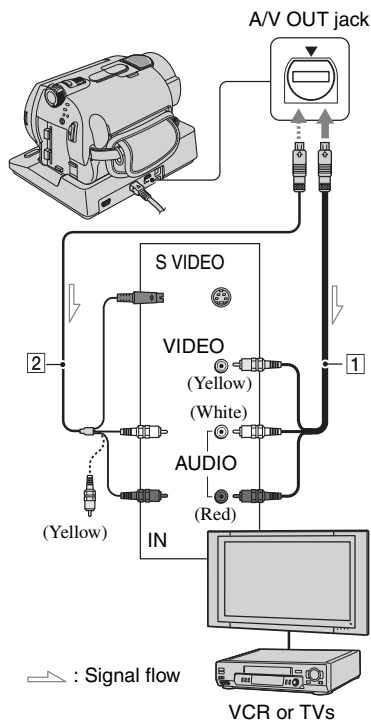

- You can dub the images recorded on the camcorder to VCR or DVD/HDD recorders. For details, see “Handycam Handbook” (PDF).

Performing with a computer

In the supplied CD-ROM, “Handycam Handbook” (PDF) and “Picture Motion Browser” (Software) are contained.

On the advanced use of your camcorder or how to use connecting to your computer, see “Handycam Handbook” (PDF).

By using “Picture Motion Browser,” you can enjoy the following operations:

- Creating a DVD with One Touch
- Importing images to a computer
- Editing the imported images
- Creating a DVD

Install the above on a computer by following the steps below.

Viewing “Handycam Handbook” (PDF)

To view “Handycam Handbook,” you need to install Adobe Reader on your computer.

■ For Windows user

- ① Turn on the computer.
- ② Place the CD-ROM (supplied) in the disc drive of your computer.
The select screen for installation appears.



- ③ Click [Handycam Handbook].
The installation screen for “Handycam Handbook” appears.

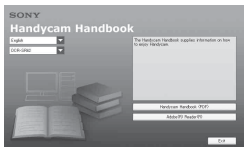

- ④ Select desired language and select the model name of your Handycam, then click [Handycam Handbook (PDF)].
Installation starts. When the installation

is completed, the short-cut icon of “Handycam Handbook” appears on the desktop of your computer.

- The model name of your Handycam is printed on its bottom surface.

- ⑤ Click [Exit] → [Exit], then remove the CD-ROM from the disc drive of your computer.

■ For Macintosh user

- ① Turn on the computer.
- ② Place the CD-ROM (supplied) in the disc drive of your computer.
- ③ Open the [Handbook] folder in the CD-ROM, double-click the [US] folder and then drag-and-drop the “Handbook.pdf” on the computer.

After having the software installed, double-click “Handbook.pdf”, you can view the handbook.

Installing the supplied software

- The supplied software is not compatible with Macintosh.

■ System requirements

When using the supplied software, you need the following system requirements below.

OS: Microsoft Windows 2000 Professional, Windows XP Home Edition, Windows XP Professional, or Windows XP Media Center Edition

Standard installation is required.

Operation is not assured if the above OS has been upgraded or in a multi-boot environment.

CPU: Intel Pentium III 1 GHz or faster

Application: DirectX 9.0c or later (This product is based on DirectX technology. It is necessary to have DirectX installed.)

Sound system: Direct Sound compatible sound card

Memory: 256 MB or more

Hard disk: Available free hard disk space for installation required: Approximately 600 MB (for creating a DVD, 5 GB or more may be required)

Display: DirectX 7 or later-compatible video card, Minimum 1024 × 768 dots, High Color (16 bit color)

Others:  USB port (this must be provided as standard), Disc drive that can burn DVDs (CD-ROM drive required for software installation)

- Even in a computer environment where the operations are guaranteed, frames may be dropped from movies, resulting in uneven playback. However, imported images and images on a DVD created subsequently will not be affected.
- Operations are not guaranteed, even on computers fulfilling the above system requirements.
- Picture Motion Browser does not support 5.1ch surround sound reproduction. The sound is reproduced in 2ch sound.
- If you use a Notebook computer, connect it to the AC Adaptor as the power source. Otherwise, the software will not work properly due to the power saving function of the computer.

■ Installing software

You need to install the software to your Windows computer **before connecting your camcorder to the computer**. The installation is required only for the first time. Provide the camcorder and the Handycam Station, and a USB cable beforehand. Contents to be installed and procedures may differ depending on your OS.

- ① Confirm that your camcorder is not connected to the computer.
- ② Turn on the computer.
 - Log on as Administrators for installation.
 - Close all applications running on the computer before installing the software.

- ③ Place the supplied CD-ROM in the disc drive of your computer. The installation screen appears.



If the screen does not appear

- ① Click [Start], then click [My Computer]. (For Windows 2000, double-click [My Computer].)
- ② Double-click [SONYPICUTIL (E:)] (CD-ROM) (disc drive).*
 - * Drive names (such as (E:)) may vary depending on the computer.
- ④ Click [Install].
- ⑤ Select the language for the application to be installed, then click [Next].
- ⑥ Check your area and country/region, then click [Next].
 - The software is set up for your selected country/region.
- ⑦ Read [License Agreement], select [I accept the terms of the license agreement] when you agree, then click [Next].
- ⑧ Set the camcorder onto the Handycam Station, then turn the POWER switch to turn on.
- ⑨ Connect the Handycam Station to your computer using the supplied USB cable, then click [Next] on the connection confirmation screen.

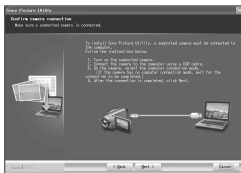

Even if a screen prompting you to restart your computer appears, you do not need to restart it at this time. Restart your computer after completing the installation.

- ⑩ Follow the on-screen instructions to install the software.
Depending on the computer, you may need to install third party software (shown below). If the installation screen appears, follow the instructions to install the required software.

– Windows Media Format 9 Series Runtime
(Windows 2000 only)
Software required to create a DVD

– Microsoft DirectX 9.0c
Software required to handle movies

Restart the computer if required to complete the installation.

The short-cut icons, such as [] (Picture Motion Browser), appear on the desktop.

- ⑪ Remove the CD-ROM from the disc drive of your computer.

- For disconnecting the USB cable, see “Handycam Handbook” (PDF).



After you install the software, a shortcut icon for the customers registration website is created on the desktop.

- Once you register on the website, you can get secure and useful customer support.
<http://www.sony.net/registration/di/>

- For the information about Picture Motion Browser, visit the following URL:
<http://www.sony.net/support-disoft/>

Performing various functions - “ HOME” and “ OPTION”

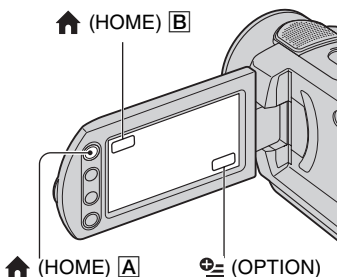



Using the HOME MENU

You can change the recording functions and the operating settings for your convenience. For details, see “Handycam Handbook” (PDF).

1 Turn on your camcorder, then press  (HOME) [A] (or [B]).



2 Touch the desired setup item.

3 Follow the guide on the screen for further operation.

- If the item is not on the screen, touch  to change the page.
- To hide the HOME MENU screen, touch [].
- You cannot select or activate simultaneously the grayed items in the current recording/playback situation.

To see the explanation of the function of each item on the HOME MENU (HELP)

- ① Press  (HOME).

- ② Touch  (HELP).
The bottom of the  (HELP) button turns orange.



- ③ Touch the item you want to know the content.
When you touch an item, its explanation appears on the screen.
To apply the option, touch [YES].

Using the OPTION MENU

The OPTION MENU appears just like the pop-up window that appears when you right-click the mouse on a computer. Various functions are displayed in the context of the operation. For details, see “Handycam Handbook” (PDF).

- 1** While using your camcorder, touch  (OPTION) on the screen.

- 2** Touch the desired item.

- 3** Change the setting, then touch .

- When the item you want is not on the screen, touch another tab. If you cannot find the item anywhere, the function does not work under the situation.
- The tabs and items that appear on the screen depend on the recording/playback status of your camcorder at the time.
- Some items appear without a tab.
- The OPTION MENU cannot be used during Easy Handycam operation (p.16).

Items of the HOME MENU



(CAMERA) category



MOVIE
PHOTO
SMTH SLW REC*1





(VIEW IMAGES) category



VISUAL INDEX
PLAYLIST



(OTHERS) category

DELETE
[ DELETE], [ DELETE]



EDIT
[ DELETE], [ DELETE],
[DIVIDE], [COPY]

PLAYLIST EDIT
[ ERASE], [ ERASE ALL], [ MOVE], [ ADD], [ ADD by date]

PRINT
[ PRINT], [ PRINT]

COMPUTER
[ COMPUTER], [ COMPUTER], [DISC BURN]

(MANAGE HDD/MEMORY) category

 FORMAT
 FORMAT
 INFO

(SETTINGS) category

MOVIE SETTINGS



[REC MODE], [NIGHTSHOT LIGHT], [WIDE SELECT]^{*2}, [DIGITAL ZOOM], [STEADYSHOT], [AUTO SLW SHUTTR], [GUIDEFAME]^{*1}, [ZEBRA]^{*1}, [ REMAINING], [FLASH LEVEL]^{*1}, [REDEYE REDUC]^{*1}

PHOTO SETTINGS

[ IMAGE SIZE]^{*3*4}, [ QUALITY], [FILE NO.], [NIGHTSHOT LIGHT], [STEADYSHOT]^{*5}, [GUIDEFAME]^{*1}, [ZEBRA]^{*1}, [FLASH LEVEL]^{*3}, [REDEYE REDUC]^{*3}, [STILL MEDIA]^{*4}

VIEW IMAGES SET

[DATA CODE], [ DISPLAY]

SOUND/DISP SET^{*6}

[VOLUME]^{*4}, [BEEP]^{*4}, [LCD BRIGHT], [LCD BL LEVEL], [LCD COLOR]

OUTPUT SETTINGS

[TV TYPE], [DISP OUTPUT]

CLOCK/ LANG

[CLOCK SET]^{*4}, [AREA SET], [DST SET]/[SUMMERTIME], [ LANGUAGE SET]^{*4}

GENERAL SET

[DEMO MODE], [CALIBRATION], [A.SHUT OFF], [REMOTE CTRL]^{*3}, [DROP SENSOR]

^{*1} DCR-SR200/SR300

^{*2} DCR-SR42

^{*3} DCR-SR62/SR82/SR200/SR300

^{*4} You can set the item during Easy Handycam operation (p.16).

^{*5} DCR-SR300

^{*6} [SOUND SETTINGS] (during Easy Handycam operation (p.16))

Items of the OPTION MENU

Items you can set only on the OPTION MENU will be described below.

tab

[FOCUS], [SPOT FOCUS], [TELE MACRO], [EXPOSURE], [SPOT METER], [SCENE SELECTION], [WHITE BAL.], [COLOR SLOW SHTR], [S. NIGHTSHOT PLS]^{*1}, [SUPER NIGHTSHOT]^{*2}

tab

[FADER], [D.EFFECT], [PICT.EFFECT]

tab

[MICREF LEVEL], [SELF-TIMER], [FLASH MODE]^{*3}, [TIMING]^{*2}, [RECORD SOUND]^{*2}

– (A tab depends on the situation)

[SLIDE SHOW], [SLIDE SHOW SET]

– (No tab)

[COPIES], [DATE/TIME], [SIZE]

^{*1} DCR-SR42/SR62/SR82

^{*2} DCR-SR200/SR300

^{*3} DCR-SR62/SR82

Troubleshooting

If you run into any problems using your camcorder, use the following table to troubleshoot the problem. If the problem persists, disconnect the power source and contact your Sony dealer.

Notes before sending your camcorder for repair

- Your camcorder may be required to initialize or change the current hard disk of the camcorder, depending on the problem. In the event of this, the data stored on the hard disk will be deleted. Be sure to save the data on the internal hard disk (see “Handycam Handbook” (PDF)) on other media (backup) before sending your camcorder for repair. We will not compensate you for any loss of hard disk data.
- During repair, we may check a minimum amount of data stored on the hard disk in order to investigate the problem. However, your Sony dealer will neither copy nor retain your data.

The power does not turn on.

- Attach a charged battery pack to the camcorder (p.11).
- Connect the plug of the AC Adaptor to the wall outlet (p.11).
- Set the camcorder onto the Handycam Station securely (p.11).

The camcorder does not operate even when the power is set to on.

- It takes a few seconds for your camcorder to be ready to shoot after the power is turned on. This is not a malfunction.
- Disconnect the AC Adaptor from the wall outlet or remove the battery pack, then reconnect it after about 1 minute. If the functions still do not work, press the RESET button (p.20) using a sharp-pointed object. (If you press the RESET button, all settings, including the clock setting, are reset.)
- The temperature of your camcorder is extremely high. Turn off your camcorder and leave it for a while in a cool place.
- The temperature of your camcorder is extremely low. Turn off the camcorder

and take it to a warm place. Leave the camcorder there for a while, then turn on the camcorder.

Buttons do not work.

- During Easy Handycam operation, available buttons/functions are limited. Cancel Easy Handycam operation. For details on Easy Handycam operation, refer to “Handycam Handbook” (PDF).

Your camcorder gets warm.

- This is because the power has been turned on for a long time. This is not a malfunction.

The power abruptly turns off.

- When approximately 5 minutes have elapsed while you do not operate your camcorder, the camcorder is automatically turned off (A.SHUT OFF). Change the setting of [A.SHUT OFF], or turn on the power again, or use the AC Adaptor.
- Charge the battery pack (p.11).

Pressing START/STOP or PHOTO does not record images.

- The playback screen is displayed. Set your camcorder to recording standby (p.15).
- Your camcorder is recording the image you have just shot on the hard disk. You cannot make new recording during this period.
- The hard disk of the camcorder is full. Delete unnecessary images (p.24).
- Total number of movies or still images exceeds the recordable capacity of your camcorder. Delete unnecessary images (p.24).

The recording stops.

- The temperature of your camcorder is extremely high/low. Turn off your camcorder and leave it for a while in a cool/warm place.

Warning indicators

Menu items are grayed out.

- There are some functions you cannot activate simultaneously. For details, see “Handycam Handbook” (PDF).

Lights appear on the screen even if the lens cover is closed (DCR-SR42/SR62/SR82).

- When you turn on your camcorder while the lens cover is closed, lights through gaps of the lens cover may appear on the screen. This is not a malfunction.

Self-diagnosis display/Warning indicators

If indicators appear on the LCD screen, check the following.

Some symptoms you can fix by yourself. If the problem persists even after you have tried a couple of times, contact your Sony dealer or local authorized Sony service facility.

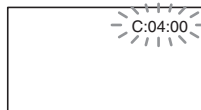

C:(or E:) □□:□□ (Self-diagnosis display)

C:04:□□

- The battery pack is not an “InfoLITHIUM” battery pack. Use an “InfoLITHIUM” battery pack (p.11).
- Connect the DC plug of the AC Adaptor to the DC IN jack of the Handycam Station or your camcorder securely (p.11).

C:13:□□ / C:32:□□

- Remove the power source. Reconnect it and operate your camcorder again.
- Turn on your camcorder again.

E:20:□□ / E:31:□□ / E:61:□□ / E:62:□□ / E:91:□□ / E:94:□□

- A malfunction that you cannot service has occurred. Contact your Sony dealer or local authorized Sony service facility. Inform them of the 5-digit code, which starts from “E.”

101-0001 (Warning indicator pertaining to files)

Slow flashing

- The file is damaged.
- The file is unreadable.

 **(Warning on the hard disk of the camcorder)***

Fast flashing

- An error may have occurred with the hard disk drive in your camcorder.

 **(Warning on the hard disk of the camcorder)***

Fast flashing

- The hard disk of the camcorder is fully recorded.
- An error may have occurred with the hard disk drive in your camcorder.

 **(Battery level warning)**

Slow flashing

- The battery pack is nearly used up.
- Depending on the operating environment or battery conditions,  may flash, even if there are approximately 20 minutes remaining.

 **(High temperature warning)**

Slow flashing

- The temperature of your camcorder is getting higher. Turn off your camcorder and leave it for a while in a cool place.

Fast flashing*

- The temperature of your camcorder is extremely high. Turn off your camcorder and leave it for a while in a cool place.

 **(Low temperature warning)***

Fast flashing

- The temperature of your camcorder is extremely low. Make the camcorder warm.

 **(Warning indicator pertaining to “Memory Stick Duo”)**



- No “Memory Stick Duo” is inserted (p.16).

 **(Warning indicators pertaining to “Memory Stick Duo” formatting)***

- The “Memory Stick Duo” is damaged.
- The “Memory Stick Duo” is not formatted correctly.

 **(Warning indicator pertaining to incompatible “Memory Stick Duo”)***

- An incompatible “Memory Stick Duo” is inserted.

  **(Warning indicator pertaining to the write-protect of the “Memory Stick Duo”)***

- The write-protect tab on the “Memory Stick Duo” is set to lock.
- Access to the “Memory Stick Duo” was restricted on another device.

 **(Warning indicator pertaining to the flash)**

Fast flashing

- There is something wrong with the flash.

 **(Warning indicator pertaining to camera-shake warning)**

- The amount of lights is not sufficient, so camera-shake easily occurs. Use the flash.
- The camcorder is unsteady, so camera-shake easily occurs. Hold the camcorder steady with both hands and record the image. However, note that the camera-shake warning indicator does not disappear.

* You hear a melody when the warning indicators appear on the screen.

Precautions

On use and care

- Do not use or store the camcorder and accessories in the following locations:
 - Anywhere extremely hot, cold or humid. Never leave them exposed to temperatures above 60°C (140°F), such as under direct sunlight, near heaters or in a car parked in the sun. They may malfunction or become deformed.
 - Near strong magnetic fields or mechanical vibration. The camcorder may malfunction.
 - Near strong radio waves or radiation. The camcorder may not be able to record properly.
 - Near AM receivers and video equipment. Noise may occur.
 - On a sandy beach or anywhere dusty. If sand or dust gets in your camcorder, it may malfunction. Sometimes this malfunction cannot be repaired.
 - Near windows or outdoors, where the LCD screen or the lens may be exposed to direct sunlight. This damages the inside of the LCD screen.
- Operate your camcorder on DC 6.8 V/7.2 V (battery pack) or DC 8.4 V (AC Adaptor).
- For DC or AC operation, use the accessories recommended in these operating instructions.
- Do not let your camcorder get wet, for example, from rain or sea water. If your camcorder gets wet, it may malfunction. Sometimes this malfunction cannot be repaired.
- If any solid object or liquid gets inside the casing, unplug your camcorder and have it checked by a Sony dealer before operating it any further.
- Avoid rough handling, disassembling, modifying, physical shock, or impact such as hammering, dropping or stepping on the product. Be particularly careful of the lens.
- Keep the POWER switch setting to OFF (CHG) when you are not using your camcorder.
- Do not wrap your camcorder with a towel, for example, and operate it. Doing so might cause heat to build up inside.
- When disconnecting the power cord, pull it by the plug and not the cord.
- Do not damage the power cord such as by placing anything heavy on it.
- Keep metal contacts clean.

- Keep the Remote Commander and button-type battery out of children's reach. If the battery is accidentally swallowed, consult a doctor immediately (DCR-SR62/SR82/SR200/SR300).
- If the battery electrolytic liquid has leaked:
 - consult your local authorized Sony service facility.
 - wash off any liquid that may have contacted your skin.
 - if any liquid gets in your eyes, wash with plenty of water and consult a doctor.

■ When not using your camcorder for a long time

- Periodically turn it on and let it run such as by playing back or recording images for about 3 minutes.
- Use up the battery pack completely before storing it.

LCD screen

- Do not exert excessive pressure on the LCD screen, as it may cause damage.
- If your camcorder is used in a cold place, a residual image may appear on the LCD screen. This is not a malfunction.
- While using your camcorder, the back of the LCD screen may heat up. This is not a malfunction.

■ To clean the LCD screen

If fingerprints or dust make the LCD screen dirty, it is recommended you use a soft cloth to clean it. When you use the LCD Cleaning Kit (optional), do not apply the cleaning liquid directly to the LCD screen. Use cleaning paper moistened with the liquid.

On handling the casing

- If the casing is soiled, clean the camcorder body with a soft cloth lightly moistened with water, and then wipe the casing with a dry soft cloth.
- Avoid the following to avoid damage to the finish:
 - Using chemicals such as thinner, benzene, alcohol, chemical cloths, repellent, insecticide and sunscreen.
 - Handling the camcorder with above substances on your hands.
 - Leaving the casing in contact with rubber or vinyl objects for a long period of time.

Specifications

About care and storage of the lens

- Wipe the surface of the lens clean with a soft cloth in the following instances:
 - When there are fingerprints on the lens surface.
 - In hot or humid locations
 - When the lens is exposed to salty air such as at the seaside.
- Store in a well-ventilated location subject to little dirt or dust.
- To prevent mold, periodically clean the lens as described above. It is recommended that you operate your camcorder about once a month to keep it in optimum state for a long time.

On charging the pre-installed rechargeable battery

Your camcorder has a pre-installed rechargeable battery to retain the date, time, and other settings even when the POWER switch is set to OFF (CHG). The pre-installed rechargeable battery is always charged while your camcorder is connected to the wall outlet via the AC Adaptor or while the battery pack is attached. The rechargeable battery will be fully discharged in **about 3 months** if you do not use your camcorder at all. Use your camcorder after charging the pre-installed rechargeable battery.

However, even if the pre-installed rechargeable battery is not charged, the camcorder operation will not be affected as long as you are not recording the date.

■ Procedures

Connect your camcorder to a wall outlet using the supplied AC Adaptor, and leave it with the POWER switch set to OFF (CHG) for more than 24 hours.

System

Video compression format
MPEG2/JPEG (Still images)

Audio compression format
DCR-SR42/SR62/SR82
Dolby Digital 2ch
Dolby Digital Stereo Creator
DCR-SR200/SR300
Dolby Digital 2/5.1ch
Dolby Digital 5.1 Creator

Video signal
NTSC color, EIA standards

Hard Disk
DCR-SR42/SR62
30 GB
DCR-SR82
60 GB
DCR-SR200/SR300
40 GB
When measuring media capacity, 1GB equals 1 billion bytes, a portion of which is used for data management.

Recording format
Movie
MPEG2-PS
Still image
Exif *1 Ver.2.2

Recording time
DCR-SR42/SR62
HQ: Approx. 440 min
SP: Approx. 650 min
LP: Approx. 1 250 min
DCR-SR82
HQ: Approx. 880 min
SP: Approx. 1 300 min
LP: Approx. 2 510 min
DCR-SR200/SR300
HQ: Approx. 570 min
SP: Approx. 870 min
LP: Approx. 1 680 min

Recordable images/cuts
Movie: 9 999
Still image: 9 999

Image device
DCR-SR42
3.0 mm (1/6 type) CCD (Charge Coupled Device)
Gross:
Approx. 680 000 pixels
Effective (Movie):
Approx. 340 000 pixels

Effective (Still):
Approx. 340 000 pixels
DCR-SR62/SR82
3.0 mm (1/6 type) CCD (Charge Coupled Device)
Gross:
Approx. 1 070 000 pixels
Effective (Movie, 16:9)
Approx. 670 000 pixels
Effective (Movie, 4:3)
Approx. 690 000 pixels
Effective (Still, 4:3)
Approx. 1 000 000 pixels
Effective (Still, 16:9)
Approx. 750 000 pixels
DCR-SR200
5.9 mm (1/3 type) CMOS sensor
Recording pixels (still image, 4:3):
Max. 4.0 mega (2 304 × 1 728) pixels*²
Gross:
Approx. 2 100 000 pixels
Effective (Movie, 16:9)
Approx. 1 430 000 pixels
Effective (Movie, 4:3)
Approx. 1 080 000 pixels
Effective (Still, 4:3)
Approx. 1 990 000 pixels
Effective (Still, 16:9)
Approx. 1 490 000 pixels
DCR-SR300
6.3 mm (1/2.9 type) CMOS sensor
Recording pixels (still image, 4:3):
Max. 6.1 mega (2 848 × 2 136) pixels*²
Gross:
Approx. 3 200 000 pixels
Effective (Movie, 16:9)
Approx. 2 280 000 pixels
Effective (Movie, 4:3)
Approx. 1 710 000 pixels
Effective (Still, 4:3)
Approx. 3 040 000 pixels
Effective (Still, 16:9)
Approx. 2 280 000 pixels

Lens

DCR-SR42
Carl Zeiss Vario-Tessar
Optical:40 ×, Digital:80 ×, 2 000 ×
Filter diameter: 30 mm (1 3/16 in.)
DCR-SR62/SR82
Carl Zeiss Vario-Tessar
Optical:25 ×, Digital:50 ×, 2 000 ×
Filter diameter: 30 mm (1 3/16 in.)
DCR-SR200
Carl Zeiss Vario-Sonnar T*
Optical:10 ×, Digital:20 ×, 80 ×
Filter diameter: 37 mm (1 1/2 in.)

DCR-SR300
Carl Zeiss Vario-Sonnar T*
Optical:10 ×, Digital:20 ×
Filter diameter: 37 mm (1 1/2 in.)

Focal length

DCR-SR42
F=1.8 - 4.1
f=1.9 - 76.0 mm (3/32 - 3 in.)
When converted to a 35 mm still camera
For movies:
36 - 1 440 mm (1 7/16 - 56 3/4 in.)
For still images:
36 - 1 440 mm (1 7/16 - 56 3/4 in.)
DCR-SR62/SR82
F=1.8 - 3.2
f=2.5 - 62.5 mm (1/8 - 2 1/2 in.)
When converted to a 35 mm still camera
For movies:
41 - 1 189 mm (1 5/8 - 46 7/8 in.) (16:9)*³
43 - 1 075 mm (1 3/4 - 42 3/8 in.) (4:3)
For still images:
36 - 900 mm (1 7/16 - 35 1/2 in.) (4:3)
39 - 975 mm (1 9/16 - 38 1/2 in.) (16:9)
DCR-SR200
F=1.8 - 2.9
f=5.1 - 51 mm (7/32 - 2 1/8 in.)
When converted to a 35 mm still camera
For movies*³:
41.3 - 485 mm (1 11/16 - 19 1/8 in.) (16:9)
50.5 - 594 mm (2 - 23 1/2 in.) (4:3)
For still images:
37 - 370 mm (1 1/2 - 14 5/8 in.) (4:3)
40.4 - 404 mm (1 5/8 - 16 in.) (16:9)
DCR-SR300
F=1.8 - 2.9
f=5.4 - 54 mm (7/32 - 2 1/8 in.)
When converted to a 35 mm still camera
For movies:
40 - 400 mm (1 5/8 - 15 3/4 in.) (16:9)
49 - 490 mm (1 15/16 - 19 3/8 in.) (4:3)
For still images:
37 - 370 mm (1 1/2 - 14 5/8 in.) (4:3)
40 - 400 mm (1 5/8 - 15 3/4 in.) (16:9)

Color temperature

[AUTO], [ONE PUSH], [INDOOR] (3 200 K),
[OUTDOOR] (5 800 K)

Minimum illumination

DCR-SR42
3 lx (lux) (when [AUTO SLW SHUTTR] is set to [ON], Shutter speed 1/30 second)
0 lx (lux) (during NightShot plus function)
DCR-SR62/SR82
4 lx (lux) (when [AUTO SLW SHUTTR] is set to [ON], Shutter speed 1/30 second)
0 lx (lux) (during NightShot plus function)

DCR-SR200/SR300

1.5 lx (lux) (when [AUTO SLW SHUTTR] is set to [ON], Shutter speed 1/30 second)
0 lx (lux) (during NightShot function)

- *1 “Exif” is a file format for still images, established by the JEITA (Japan Electronics and Information Technology Industries Association). Files in this format can have additional information such as your camcorder’s setting information at the time of recording.
 - *2 The unique pixel array of Sony’s ClearVid CMOS Sensor and image processing system (new Enhanced Imaging Processor) allows still image resolution equivalent to the sizes described.
 - *3 In 16:9 mode, the focal length figures are actual figures resulting from wide angle pixel readout.
- Manufactured under license from Dolby Laboratories.

Input/Output connectors

Audio/Video output

10-pin connector

Video signal: 1 Vp-p, 75 Ω (ohms)

Luminance signal: 1 Vp-p, 75 Ω (ohms)

Chrominance signal: 0.286 Vp-p, 75 Ω (ohms)

Audio signal: 327 mV (at load impedance

47 kΩ (kilohms)), Output impedance less than

2.2 kΩ (kilohms)

USB output jack

mini-B

REMOTE jack (except for DCR-SR42)

Stereo mini-minijack (Ø 2.5 mm)

LCD screen

Picture

DCR-SR42

6.2 cm (2.5 type)

DCR-SR62/SR82/SR200/SR300

6.9 cm (2.7 type, aspect ratio 16:9)

Total number of pixels

DCR-SR42/SR62/SR82

123 200 (560 × 220)

DCR-SR200/SR300

211 200 (960 × 220)

General

Power requirements

6.8 V/7.2 V (battery pack)

8.4 V (AC Adaptor)

Average power consumption

During camera recording with normal brightness.

DCR-SR42

2.6 W

DCR-SR62/SR82

3.0 W

DCR-SR200

3.7 W

DCR-SR300

4.3 W

Operating temperature

0°C to +40°C (32°F to 104°F)

Storage temperature

-20°C to +60°C (-4°F to +140°F)

Dimensions (Approx.)

DCR-SR42/SR62/SR82

73 × 72 × 109 mm (2 7/8 × 2 7/8 × 4 3/8 in.)

(w×h×d) including the projecting parts

73 × 72 × 115 mm (2 7/8 × 2 7/8 × 4 5/8 in.)

(w×h×d) including the projecting parts with

supplied battery pack NP-FH40 attached

DCR-SR200/SR300

76 × 78 × 128 mm (3 × 3 1/8 × 5 1/8 in.)

(w×h×d) including the projecting parts

76 × 78 × 149 mm (3 × 3 1/8 × 5 7/8 in.)

(w×h×d) including the projecting parts with

supplied battery pack NP-FH60 attached

Mass (Approx.)

DCR-SR42

335 g (11 oz) main unit only

380 g (13 oz) including the NP-FH40

rechargeable battery pack

DCR-SR62

350 g (12 oz) main unit only

395 g (14 oz) including the NP-FH40

rechargeable battery pack

DCR-SR82

360 g (12 oz) main unit only

405 g (14 oz) including the NP-FH40

rechargeable battery pack

DCR-SR200

455 g (1 lb) main unit only

535 g (1 lb 2 oz) including the NP-FH60

rechargeable battery pack

DCR-SR300

480 g (1 lb 1 oz) main unit only

560 g (1 lb 3 oz) including the NP-FH60

rechargeable battery pack

Supplied accessories

See page 9.

Handycam Station DCRA-C171

Input/Output connectors

Audio/Video output

10 pin connector
Video signal: 1 Vp-p, 75 Ω (ohms)
Luminance signal: 1 Vp-p, 75 Ω (ohms)
Chrominance signal: 0.286 Vp-p, 75 Ω (ohms)
Audio signal: 327 mV (at load impedance
47 k Ω (kilohms)), Output impedance less than
2.2 k Ω (kilohms)

USB jack

mini-B

AC Adaptor AC-L200/L200B

Power requirements

AC 100 - 240 V, 50/60 Hz

Current consumption

0.35 - 0.18 A

Power consumption

18 W

Output voltage

DC 8.4 V*

Operating temperature

0°C to + 40°C (32°F to 104°F)

Storage temperature

-20°C to + 60°C (-4°F to + 140°F)

Dimensions (Approx.)

48 × 29 × 81 mm (1 15/16 × 1 3/16 × 3 1/4
in.)(w×h×d) excluding the projecting parts

Mass (Approx.)

170 g (6.0 oz) excluding the power cord

* See at the label of AC Adaptor for other specifications.

Rechargeable battery pack

NP-FH40 (DCR-SR42/SR62/SR82)

Maximum output voltage

DC 8.4 V

Output voltage

DC 7.2 V

Capacity

4.9 wh (680 mAh)

Dimensions (Approx.)

31.8 × 18.5 × 45.0 mm
(1 5/16 × 3/4 × 1 13/16 in.)(w×h×d)

Mass (Approx.)

45 g (1.6 oz)

Operating temperature

0°C to + 40°C (32°F to 104°F)

Type

Li-ion

NP-FH60 (DCR-SR200/SR300)

Maximum output voltage

DC 8.4 V

Output voltage

DC 7.2 V

Capacity

7.2 wh (1 000 mAh)

Dimensions (Approx.)

31.8 × 33.3 × 45.0 mm
(1 5/16 × 1 5/16 × 1 13/16 in.)(w×h×d)

Mass (Approx.)

80 g (2.9 oz)

Operating temperature

0°C to + 40°C (32°F to 104°F)

Type

Li-ion

Design and specifications are subject to change without notice.

On trademarks

- “Handycam” and **HANDYCAM** are registered trademarks of Sony Corporation.
- “Memory Stick,”  “Memory Stick Duo,” **MEMORY STICK DUO**, “Memory Stick PRO Duo,” **MEMORY STICK PRO DUO**, “MagicGate,” **MAGIC GATE**, “MagicGate Memory Stick” and “MagicGate Memory Stick Duo” are trademarks of Sony Corporation.
- “InfoLITHIUM” is a trademark of Sony Corporation.
- DVD-R, DVD+R DL, DVD-RW, and DVD+RW logo are trademarks.
- Dolby and the double-D symbol are trademarks of Dolby Laboratories.
- Dolby Digital 5.1 Creator is a trademark of Dolby Laboratories.
- Microsoft, Windows, and Windows Media are trademarks or registered trademarks of U.S. Microsoft Corporation in the U.S. and other countries.
- Macintosh and Mac OS are registered trademarks of Apple Computer, Inc. in the U.S. and other countries.
- Intel, Intel Core, and Pentium are trademarks or registered trademarks of Intel Corporation or its subsidiaries in the United States and other countries.
- Adobe, the Adobe logo, and Adobe Acrobat are either registered trademarks or trademarks of Adobe Systems Incorporated in the United States and/or other countries.

All other product names mentioned herein may be the trademarks or registered trademarks of their respective companies. Furthermore, TM and [®] are not mentioned in each case in this manual.

Additional information on this product and answers to frequently asked questions can be found at our Customer Support Website.

<http://www.sony.net/>



Printed on 70% or more recycled paper
using VOC (Volatile Organic Compound)-
free vegetable oil based ink.

Printed in Japan



3098548110