

SONY

3-278-987-12(1)

Digital HD Video Camera Recorder

HANDYCAM

Operating Guide

HDR-HC9

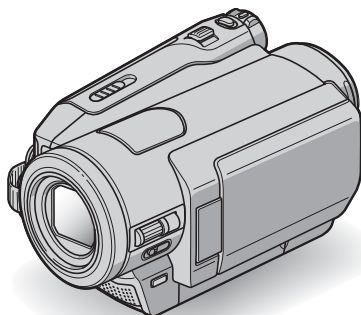

 Enjoying pictures with high definition quality **10**

Getting Started **12**

 Recording/
Playback **21**

Using the Menu **39**

Dubbing/Editing **64**

Using a Computer **73**

Troubleshooting **78**

Additional Information **90**

Quick Reference **103**

Spanish Quick Guide/
Guía rápida en español **115**

HDV

Mini DV Digital Video Cassette

 MEMORY STICK™

 InfoLITHIUM™

 H SERIES

HDMI

HDV 1080i

WARNING

To reduce fire or shock hazard, do not expose the unit to rain or moisture.

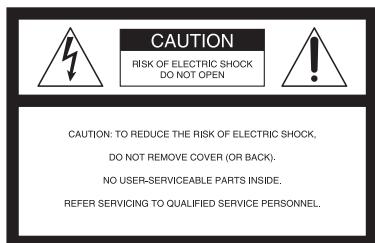

This symbol is intended to alert the user to the presence of uninsulated "dangerous voltage" within the product's enclosure that may be of sufficient magnitude to constitute a risk of electric shock to persons.



This symbol is intended to alert the user to the presence of important operating and maintenance (servicing) instructions in the literature accompanying the appliance.

IMPORTANT SAFEGUARDS

For your protection, please read these safety instructions completely before operating the appliance, and keep this manual for future reference.

Carefully observe all warnings, precautions and instructions on the appliance, or the one described in the operating instructions and adhere to them.

Use

Power Sources

This set should be operated only from the type of power source indicated on the marking label. If you are not sure of the type of electrical power supplied to your home, consult your dealer or local power company. For those sets designed to operate from battery power, or other sources, refer to the operating instructions.

Polarization

This set may be equipped with a polarized ac power cord plug (a plug having one blade wider than the other).

This plug will fit into the power outlet only one way. This is a safety feature. If you are unable to insert the plug fully into the outlet, try reversing the plug. If the plug should still fail to fit, contact your electrician to have a suitable outlet installed. Do not defeat the safety purpose of the polarized plug by forcing it in.

Overloading

Do not overload wall outlets, extension cords or convenience receptacles beyond their capacity, since this can result in fire or electric shock.

Object and Liquid Entry

Never push objects of any kind into the set through openings as they may touch dangerous voltage points or short out parts that could result in a fire or electric shock. Never spill liquid of any kind on the set.

Attachments

Do not use attachments not recommended by the manufacturer, as they may cause hazards.

Cleaning

Unplug the set from the wall outlet before cleaning or polishing it. Do not use liquid cleaners or aerosol cleaners. Use a cloth lightly dampened with water for cleaning the exterior of the set.

Installation

Water and Moisture

Do not use power-line operated sets near water – for example, near a bathtub, washbowl, kitchen sink, or laundry tub, in a wet basement, or near a swimming pool, etc.

Power-Cord Protection

Route the power cord so that it is not likely to be walked on or pinched by items placed upon or against them, paying particular attention to the plugs, receptacles, and the point where the cord exits from the appliance.

Accessories

Do not place the set on an unstable cart, stand, tripod, bracket, or table. The set may fall, causing serious injury to a child or an adult, and serious damage to the set. Use only a cart, stand, tripod, bracket, or table recommended by the manufacturer.

Ventilation

The slots and openings in the cabinet are provided for necessary ventilation. To ensure reliable operation of the set, and to protect it from overheating, these slots and openings must never be blocked or covered.

- Never cover the slots and openings with a cloth or other materials.
- Never block the slots and openings by placing the set on a bed, sofa, rug, or other similar surface.
- Never place the set in a confined space, such as a bookcase, or built-in cabinet, unless proper ventilation is provided.
- Do not place the set near or over a radiator or heat register, or where it is exposed to direct sunlight.

Lightning

For added protection for this set during a lightning storm, or when it is left unattended and unused for

long periods of time, unplug it from the wall outlet and disconnect the antenna or cable system. This will prevent damage to the set due to lightning and power-line surges.

Service

Damage Requiring Service

Unplug the set from the wall outlet and refer servicing to qualified service personnel under the following conditions:

- When the power cord or plug is damaged or frayed.
- If liquid has been spilled or objects have fallen into the set.
- If the set has been exposed to rain or water.
- If the set has been subject to excessive shock by being dropped, or the cabinet has been damaged.
- If the set does not operate normally when following the operating instructions. Adjust only those controls that are specified in the operating instructions. Improper adjustment of other controls may result in damage and will often require extensive work by a qualified technician to restore the set to normal operation.
- When the set exhibits a distinct change in performance – this indicates a need for service.

Servicing

Do not attempt to service the set yourself as opening or removing covers may expose you to dangerous voltage or other hazards.

Refer all servicing to qualified service personnel.

Replacement parts

When replacement parts are required, be sure the service technician has used replacement parts specified by the manufacturer that have the same characteristics as the original parts.

Unauthorized substitutions may result in fire, electric shock, or other hazards.

Safety Check

Upon completion of any service or repairs to the set, ask the service technician to perform routine safety checks (as specified by the manufacturer) to determine that the set is in safe operating condition.

Read this first

Before operating the unit, please read this manual thoroughly, and retain it for future reference.

WARNING

Do not expose the batteries to excessive heat such as sunshine, fire or the like.

Excessive sound pressure from earphones and headphones can cause hearing loss.

CAUTION

Replace the battery with the specified type only. Otherwise, fire or injury may result.

For customers in the U.S.A. and CANADA

RECYCLING LITHIUM-ION BATTERIES

Lithium-Ion batteries are recyclable.

You can help preserve our environment by returning your used rechargeable batteries to the collection and recycling location nearest you.

For more information regarding recycling of rechargeable batteries, call toll free 1-800-822-8837, or visit <http://www.rbrcc.org/>

Caution: Do not handle damaged or leaking Lithium-Ion batteries.

Battery pack

This device complies with Part 15 of the FCC Rules. Operation is subject to the following two conditions:

(1) This device may not cause harmful interference, and (2) this device must accept any interference received, including interference that may cause undesired operation.

This Class B digital apparatus complies with Canadian ICES-003.



Owner's Record

The model and serial numbers are located on the bottom. Record the serial number in the space provided below. Refer to these numbers whenever you call your Sony dealer regarding this product.

Model No. HDR-HC9

Serial No.

Model No. AC-

Serial No.

For customers in the U.S.A.

If you have any questions about this product, you may call:
Sony Customer Information Center 1-800-222-SONY (7669).

The number below is for the FCC related matters only.

Regulatory Information

Declaration of Conformity

Trade Name: SONY

Model No.: HDR-HC9

Responsible Party: Sony Electronics Inc.

Address: 16530 Via Esprillo, San Diego, CA 92127 U.S.A.

Telephone number: 858-942-2230

This device complies with Part 15 of the FCC Rules.

Operation is subject to the following two conditions:

(1) This device may not cause harmful interference, and (2) this device must accept any interference received, including interference that may cause undesired operation.

Notes

HDR-HC9 is to be used with AC Adaptor Model AC-L200/L200B.

CAUTION

You are cautioned that any changes or modifications not expressly approved in this manual could void your authority to operate this equipment.

Note

This equipment has been tested and found to comply with the limits for a Class B digital device, pursuant to Part 15 of the FCC Rules.

These limits are designed to provide reasonable protection against harmful interference in a residential installation. This equipment generates, uses, and can radiate radio frequency energy and, if not installed and used in accordance with the instructions, may cause harmful interference to radio communications.

However, there is no guarantee that interference will not occur in a particular installation. If this equipment does cause harmful interference to radio or television reception, which can be determined by turning the equipment off and on, the user is encouraged to try to correct the interference by one or more of the following measures:

- Reorient or relocate the receiving antenna.
- Increase the separation between the equipment and receiver.
- Connect the equipment into an outlet on a circuit different from that to which the receiver is connected.
- Consult the dealer or an experienced radio/TV technician for help.

The supplied interface cable must be used with the equipment in order to comply with the limits for a digital device pursuant to Subpart B of Part 15 of FCC Rules.

For the State of California, USA only

Perchlorate Material - special handling may apply, See

www.dtsc.ca.gov/hazardouswaste/perchlorate

Perchlorate Material: Lithium battery contains perchlorate.

Notes on use

Your camcorder is supplied with two kinds of manuals

- “Operating Guide” (This manual)
- “First Step Guide” for using your camcorder while connected to a computer (stored on the supplied CD-ROM)

Type of cassette you can use in your camcorder

You can use mini DV cassettes marked with . Your camcorder is not compatible with the Cassette Memory function (p. 91).

Types of “Memory Stick” you can use in your camcorder

You can use “Memory Stick” that have the logo shown below (p. 92).

- MEMORY STICK DUO (“Memory Stick Duo”)
- MEMORY STICK PRO DUO (“Memory Stick PRO Duo”)
- MEMORY STICK PRO-HG DUO (“Memory Stick PRO-HG Duo”)

“Memory Stick Duo”
(This size can be used with your camcorder.)



“Memory Stick”
(You cannot use with your camcorder.)



- You cannot use any type of memory card except “Memory Stick Duo.”
- “Memory Stick PRO Duo” can be used only with “Memory Stick PRO” compatible equipment.

Read this first (Continued)

- Do not attach a label or the like on a “Memory Stick Duo” or a Memory Stick Duo adaptor.

When using a “Memory Stick Duo” with “Memory Stick” compatible equipment

Be sure to insert the “Memory Stick Duo” into the Memory Stick Duo Adaptor.

Memory Stick Duo Adaptor



Using the camcorder

- Do not hold the camcorder by the following parts.

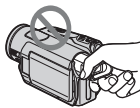

Viewfinder



LCD panel

- The camcorder is not dustproof, dripproof or waterproof.
See “On using your camcorder” (p. 96).
- When connecting your camcorder to another device with communication cables, be sure to insert the connector plug in the correct way.
Pushing the plug forcibly into the terminal will damage the terminal and may result in a malfunction of your camcorder.

About menu items, LCD panel, viewfinder, and lens

- A menu item that is grayed out is not available under the current recording or playback conditions.
- The LCD screen and the viewfinder are manufactured using extremely high-precision technology, so over 99.99% of the pixels are operational for effective use. However, there may be some tiny

black points and/or bright points (white, red, blue, or green in color) that appear constantly on the LCD screen and the viewfinder. These points are normal results of the manufacturing process and do not affect the recording in any way.

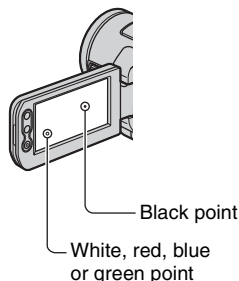

- Exposing the LCD screen, the viewfinder, or the lens to direct sunlight for long periods of time may cause malfunctions.
- Do not aim at the sun. Doing so might cause your camcorder to malfunction.
Take pictures of the sun only in low light conditions, such as at dusk.

About changing the language setting

The on-screen displays in each local language are used for illustrating the operating procedures. Change the screen language before using your camcorder if necessary (p. 17).

On recording

- Before starting to record, test the recording function to make sure the picture and sound are recorded without any problems.
- Compensation for the contents of recordings cannot be provided, even if recording or playback is not possible due to a malfunction of the camcorder, storage media, etc.
- TV color systems differ depending on the country/region. To view your recordings

on a TV, you need an NTSC system-based TV.

- Television programs, films, video tapes, and other materials may be copyrighted. Unauthorized recording of such materials may be contrary to the copyright laws.

On playing back HDV tapes on other devices

You cannot play back a tape recorded in the HDV format on DV format video cameras or on mini DV players (The screen appears blue).

Check the contents of tapes by playing them back on this camcorder prior to playing them back on other devices.

About this manual

- The images of the LCD screen and the viewfinder used in this manual for illustration purposes are captured using a digital still camera, and therefore may appear different.
- Design and specifications of recording media and other accessories are subject to change without notice.

About the Carl Zeiss lens

Your camcorder is equipped with a Carl Zeiss lens, which was developed jointly by Carl Zeiss, in Germany, and Sony Corporation, and produces superior images. It adopts the MTF measurement system for video cameras and offers a quality typical of a Carl Zeiss lens. Also, the lens for your camcorder is T*₂-coated to suppress unwanted reflections and faithfully reproduce colors.

MTF= Modulation Transfer Function
The number value indicates the amount of light from a subject coming into the lens.

Table of Contents

Note on the icons used in this manual

 Features available for the HDV format only

 Features available for the DV format only

IMPORTANT SAFEGUARDS	2
Read this first	4
Notes on use	5



Enjoying pictures with high definition quality

Trying out the HDV format!	10
Viewing video recorded in the HDV format!	11

Getting Started

Step 1: Checking supplied items	12
Step 2: Charging the battery pack	13
Step 3: Turning the power on and setting the date and time	16
Step 4: Making setting adjustments before recording	18
Step 5: Inserting a tape or a "Memory Stick Duo"	19





Recording/Playback

Easy Recording/Playback (Easy Handycam)	21
Recording	23
Zooming	25
Recording high quality still images during tape recording (Dual Rec)	25
Controlling the image settings manually with the CAM CTRL dial	26
Using the flash	26
Recording in dark places (NightShot)	27
Adjusting the exposure for backlit subjects	27
Recording in mirror mode	27

Playback	28
Using PB zoom	30
Using the guide functions (USAGE GUIDE)	31
Searching for the starting point	32
Searching for the last scene of the most recent recording (END SEARCH)	32
Reviewing the most recently recorded scenes (Rec review)	32
Searching quickly for a desired scene (Zero set memory)	32
Searching for a scene by date of recording (Date search)	33
Playing the picture on a TV	34
Selecting the appropriate connection method (CCONNECT GUIDE)	34
Connecting to a high definition TV	35
Connecting to a 16:9 (wide) or 4:3 TV	36

Using the Menu

<i>Using the menu items</i>	39
Menu items	40
 CAMERA SET menu	42
Settings to adjust your camcorder to the recording conditions	
 MEMORY SET menu	49
Settings for the "Memory Stick Duo"	
 PICT.APPLI. menu	52
Special effects on pictures or additional functions on recording/playback	
 EDIT/PLAY menu	55
Settings for editing or playing back in various modes	
 STANDARD SET menu	56
Settings while recording on a tape or other basic settings	
 TIME/LANGU. menu	62
Customizing Personal Menu	62

Dubbing/Editing

Dubbing to VCR or DVD/HDD recorders	64
Recording pictures from a VCR, etc.	67
Dubbing pictures from a tape to a “Memory Stick Duo”	69
Deleting recorded pictures from the “Memory Stick Duo”	69
Marking images on the “Memory Stick Duo” with specific information (Print mark/Image protection)	70
Printing recorded images (PictBridge compliant printer)	71

Using a Computer

What you can do with Windows computer	73
Installing the “First Step Guide” and software	75
Viewing “First Step Guide”	77
Using a Macintosh computer	77

Troubleshooting

Troubleshooting	78
Warning indicators and messages	87

Additional Information

Using your camcorder abroad	90
Maintenance and precautions	91
Usable cassette tapes	91
About the “Memory Stick”	92
About the “InfoLITHIUM” battery pack	93
About i.LINK	95
About x.v.Color	96
On using your camcorder	96
Specifications	99

Quick Reference

Identifying parts and controls	103
Indicators displayed during recording/playback	107
Index	111

Spanish Quick Guide/ Guía rápida en español 115

Trying out the HDV format!

Shooting in the HDV format

High image quality

Being HDV format compliant, your camcorder is ready to shoot crystal clear, high-definition images.

? What is the HDV format?

The HDV format is a video format for shooting and playing back high definition images on popular DV standard cassette tapes.

- **Your camcorder adopts the HDV1080i specification, which utilizes 1,080 effective scanning lines, within the HDV standards,** and records pictures at the image bit rate of about 25 Mbps.



1,080 effective scanning lines

- These operating instructions refer to the HDV1080i specification as HDV format unless there is a need to specify.

? Why shoot in the HDV format?

With the global standard moving to the digital video format, you can record important moments in HDV format to keep high quality images for the future.

Your camcorder's down convert function converts pictures in HDV format to SD (standard definition) image quality for viewing on older wide TV formats, and on 4:3 aspect ratio TVs when a high definition TV set is not available. This provides an easy path to HDV format video.

- The down convert function converts HDV format video to DV for playback or editing when your camcorder is connected to a TV or VCR that is not HDV1080i compliant. The resulting image is displayed in SD (standard definition).

Viewing video recorded in the HDV format!



Viewing on a high definition TV (p. 34)

Pictures recorded in the HDV format can be played back as crisp HD (high definition) pictures on a high definition TV.

- For details on HDV1080i compliant TVs, see page 34.

Viewing on a 16:9 (wide)/4:3 TV (p. 36)

Your camcorder can down convert video recorded in the HDV format to SD (standard definition) image quality for playback on a conventional TV.

Dubbing to VCR or DVD/HDD recorders (p. 64)

Connecting to an HDV1080i device

A supplied i.LINK cable allows you to copy pictures in HD (high definition) image quality.

Connecting to an HDV1080i non-compliant device

Your camcorder can down convert HDV format video to SD (standard definition) image quality to enable copying.

Connecting to a computer (p. 73)

Using the supplied software, you can import movies from a tape or still images from a “Memory Stick Duo” to the computer. You can also edit the imported movies and create a DVD-video in SD (standard definition) image quality.

Step 1: Checking supplied items

Make sure that you have following items supplied with your camcorder. The number in the parentheses indicates the number of that item supplied.

AC Adaptor (1) (p. 13)

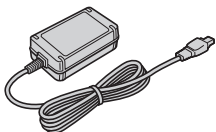

Power cord (Mains lead) (1) (p. 13)

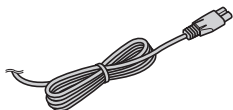

Wireless Remote Commander (1) (p. 106)



A button-type lithium battery is already installed.

A/V connecting cable (1) (p. 34, 64)



Component video cable (1) (p. 34)

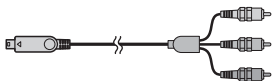

i.LINK cable (1) (p. 34, 64, 67, 75)



USB cable (1) (p. 71)

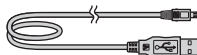

Rechargeable battery pack NP-FH60 (1) (p. 13, 93)

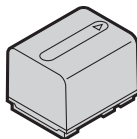

Lens hood (1) (p. 105)

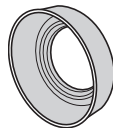

Remove the lens hood when you use the flash, Nightshot or SuperNightshot, or its shadow will appear in the picture.

CD-ROM "Handycam Application Software" (1) (p. 75)

Operating Guide (This manual) (1)

Step 2: Charging the battery pack

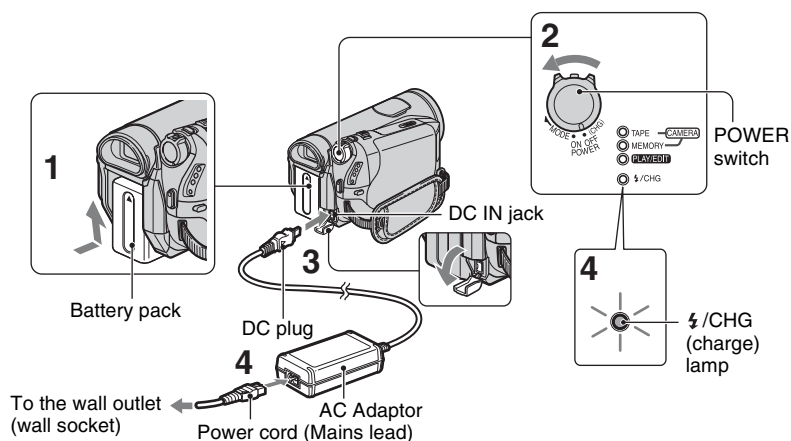

You can charge the “InfoLITHIUM” battery pack (H series) (p. 93) after attaching it to your camcorder.

Notes

- You cannot attach any “InfoLITHIUM” battery pack other than the H series to your camcorder.

1 Attach the battery pack to your camcorder.

Attach the battery pack by sliding it in the direction of the arrow until it clicks.

2 Slide the POWER switch to OFF (CHG) (the default setting).

3 Connect the AC Adaptor to the DC IN jack of your camcorder. Be sure that the ▲ mark on the DC plug is facing to the ▲ mark on your camcorder.

4 Connect the power cord (mains lead) to the AC Adaptor and the wall outlet (wall socket).

The ⚡/CHG (charge) lamp lights up and charging starts. The ⚡/CHG (charge) lamp turns off when the battery is fully charged.

Notes

- Disconnect the AC Adaptor from the DC IN jack holding both the camcorder and the DC plug.

Tips

- You can operate your camcorder connected to a power source such as a wall outlet (wall socket) as shown in the illustration. The battery pack will not lose its charge in this case.

Step2: Charging the battery pack (Continued)

To remove the battery pack

Slide the POWER switch to OFF (CHG).
Slide the BATT (battery release) lever and remove the battery pack.

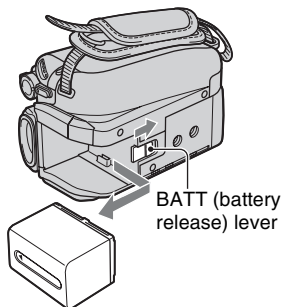

When storing the battery pack

Fully discharge the battery before storing it for an extended period (p. 94).

To check the remaining battery (Battery Info)

Set the POWER switch to OFF (CHG), then press DISPLAY/BATT INFO.

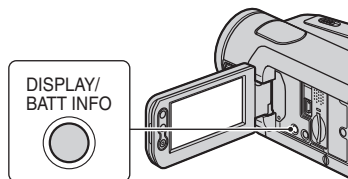

After a while, the approximate recordable time and battery information appear for about 7 seconds. You can view the battery information for up to 20 seconds by pressing DISPLAY/BATT INFO again while the information is displayed.

Remaining battery (approx.)

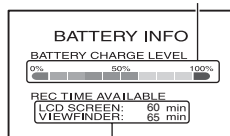

Recording capacity (approx.)

You can check the remaining battery charge on the LCD screen.

Indicator	Status
	Sufficient power remaining
	Battery low, recording/playback will stop soon.
	Replace the battery with a fully charged one, or charge the battery.

Charging time

Approximate time (min.) required when you fully charge a fully discharged battery pack.

Battery pack	Charging time
NP-FH50	135
NP-FH60 (supplied)	135
NP-FH70	170
NP-FH100	390

Recording time

Approximate time (min.) available when you use a fully charged battery pack.

Battery pack	Continuous recording time		Typical recording time*		
	HDV	DV	HDV	DV	
Recording Format	HDV	DV	HDV	DV	
	NP-FH50	70	70	40	40
		70	75	40	40
		75	80	40	45

Battery pack	Continuous recording time		Typical recording time*	
	HDV	DV	HDV	DV
Recording Format				
NP-FH60 (supplied)	90	95	50	50
	95	100	50	55
	100	105	55	55
NP-FH70	150	155	80	85
	155	165	85	90
	160	170	85	90
NP-FH100	345	365	185	195
	365	385	195	210
	375	395	205	215

* Typical recording time shows the time when you repeat recording start/stop, turning the power on/off and zooming.

Notes

- All times measured under the following conditions:
Top: When the LCD backlight turns on.
Middle: When the LCD backlight turns off.
Bottom: Recording with the viewfinder while the LCD panel is closed.

Playing time

Approximate time (min.) available when you use a fully charged battery pack.

Battery pack	LCD panel opened*		LCD panel closed	
	HDV	DV	HDV	DV
Recorded Format				
NP-FH50	105	115	120	130
NP-FH60 (supplied)	140	150	160	170
NP-FH70	230	245	255	280
NP-FH100	525	565	590	635

* When the LCD backlight turns on.

On the battery pack

- Before changing the battery pack, slide the POWER switch to OFF (CHG).

- The  /CHG (charge) lamp flashes during charging, or Battery Info (p. 14) will not be correctly displayed under the following conditions.
 - The battery pack is not attached correctly.
 - The battery pack is damaged.
 - The battery pack is worn-out (for Battery Info only).
- The power will not be supplied from the battery as long as the AC Adaptor is connected to the DC IN jack of your camcorder, even when the power cord (mains lead) is disconnected from the wall outlet (wall socket).
- When attaching an optional video light, it is recommended that you use an NP-FH70 or NP-FH100 battery pack.

On the charging/recording/playback time

- Times measured with the camcorder at 25 °C (77 °F) (10 to 30 °C (50 °F to 86 °F) is recommended).
- The recording and playback time will be shorter when you use your camcorder in low temperatures.
- The recording and playback time will be shorter depending on the conditions under which you use your camcorder.

On the AC Adaptor

- Use the nearby wall outlet (wall socket) when using the AC Adaptor. Disconnect the AC Adaptor from the wall outlet (wall socket) immediately if any malfunction occurs while using your camcorder.
- Do not use the AC Adaptor placed in a narrow space, such as between a wall and furniture.
- Do not short-circuit the DC plug of the AC Adaptor or battery terminal with any metallic objects. This may cause a malfunction.
- Even if your camcorder is turned off, AC power (house current) is still supplied to it while connected to the wall outlet (wall socket) via the AC Adaptor.

Step 3: Turning the power on and setting the date and time

Set the date and time when using this camcorder for the first time. If you do not set the date and time, the [CLOCK SET] screen appears every time you turn on your camcorder or change the POWER switch position.

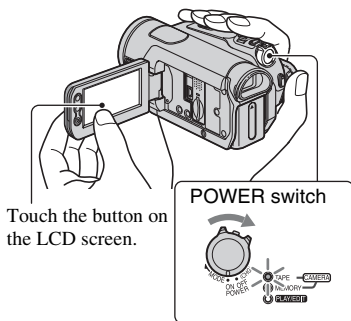

Touch the button on the LCD screen.

POWER switch

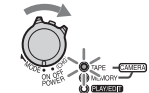

- 1 While pressing the green button, slide the POWER switch in the direction of the arrow to turn on the respective lamp.

CAMERA-TAPE: To record on a tape.

CAMERA-MEMORY: To record on a "Memory Stick Duo."

PLAY/EDIT: To play or edit pictures.

The [CLOCK SET] screen appears.

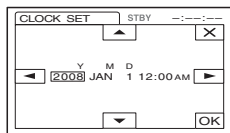

- 2 Set [Y] (year) with \uparrow/\downarrow .

You can set any year up to the year 2079.

- 3 Move to [M] (month) with \rightarrow , then set with \uparrow/\downarrow .

- 4 Move to [D] (day) with \rightarrow , then set with \uparrow/\downarrow and repeat for the hour and minute.

For midnight, set it to 12:00 AM.

For midday, set it to 12:00 PM.

- 5 Make sure the date and time settings are correct, then touch OK .

The clock starts.

To turn off the power

Slide the POWER switch to OFF (CHG).

To reset the date and time

You can set the desired date and time by touching P-MENU \rightarrow \uparrow/\downarrow \rightarrow [CLOCK SET] (p. 39).

Notes

- If you do not use your camcorder for **about 3 months**, the built-in rechargeable battery gets discharged and the date and time settings may be cleared from the memory. In that case, charge the rechargeable battery and then set the date and time again (p. 99).
- At the time of purchase, the power is set to turn off automatically if you leave your camcorder without any operation attempted for approximately 5 minutes, to save battery power ([A.SHUT OFF], p. 61).

Tips

- The date and time are not displayed while recording, but they are automatically recorded on the tape, and can be displayed during playback (see page 60 for [DATA CODE] (During Easy Handycam operation, you can set only [DATE/TIME])).

- The lens cover opens automatically when the POWER switch is set to CAMERA-TAPE or CAMERA-MEMORY.
- If the buttons on the touch panel do not work correctly, adjust the touch panel (CALIBRATION) (p. 98).

Changing the language setting

You can change the on-screen displays to show messages in a specified language.

Touch [P-MENU] → [MENU] →  (TIME/LANGU.) → [LANGUAGE], then select the desired language.

Step 4: Making setting adjustments before recording

The LCD panel

Open the LCD panel 90 degrees to the camcorder (①), then rotate it to the best angle to record or play (②).

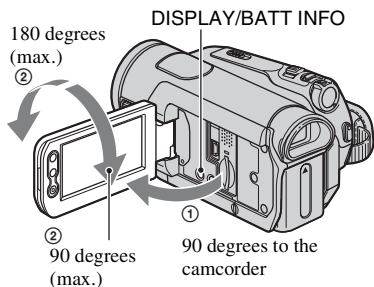

To turn off the LCD backlight to make the battery last longer

Press and hold DISPLAY/BATT INFO for a few seconds until LCD_{OFF} appears. This setting is practical when you use your camcorder in bright conditions or where you want to save battery power. The recorded picture will not be affected by the setting. To turn on the LCD backlight, press and hold DISPLAY/BATT INFO for a few seconds until LCD_{OFF} disappears.

Notes

- Do not press the buttons on the LCD panel accidentally when you open or adjust the LCD panel.

Tips

- If you rotate the LCD panel 180 degrees to the lens side, you can close the LCD panel with the LCD screen facing out. This is convenient during playback operations.
- See [LCD/VF SET] - [LCD BRIGHT] (p. 58) to adjust the brightness of the LCD screen.
- Press DISPLAY/BATT INFO to toggle the screen indicators (such as Battery Info) on or off.

The viewfinder

You can view pictures using the viewfinder to avoid wearing down the battery, or when the picture seen on the LCD screen is poor.

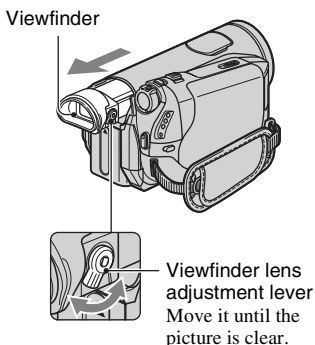

Tips

- You can adjust the brightness of the viewfinder backlight by selecting [LCD/VF SET] - [VF B.LIGHT] (p. 58).

The grip belt

Fasten the grip belt and hold your camcorder correctly.

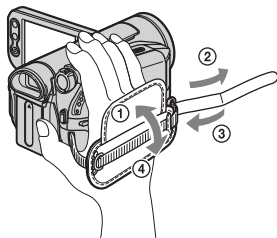

Step 5: Inserting a tape or a “Memory Stick Duo”

Cassette tape

You can use mini DV **Mini DV** cassettes only (p. 91).

Notes

- The recordable time varies depending on [RECORD MODE] (p. 57). **DV**

- 1 Slide and hold the **OPEN/EJECT** lever in the direction of the arrow and open the lid.

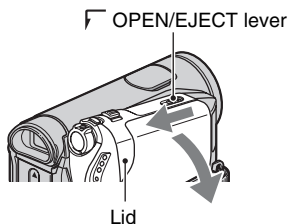

The cassette compartment automatically comes out and opens up.

- 2 Insert a cassette with its window facing outwards, then press **[PUSH]**.

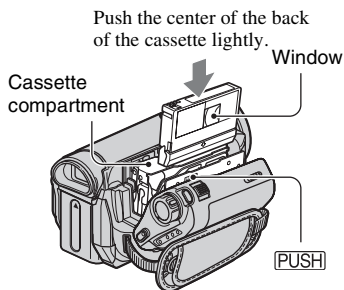

The cassette compartment automatically slides back in.

- 3 Close the lid.

To eject the cassette

Open the lid following the same procedure as described in step 1 and remove the cassette.

Notes

- Do not force the cassette compartment closed by pressing the portion marked **[DO NOT PUSH]** while it is sliding in. It may cause a malfunction.

“Memory Stick Duo”

You can use “Memory Stick” that have the logo shown below (p. 92).

- MEMORY STICK DUO (“Memory Stick Duo”)
- MEMORY STICK PRO DUO (“Memory Stick PRO Duo”)
- MEMORY STICK PRO-HG DUO (“Memory Stick PRO-HG Duo”)

Tips

- The number and time of recordable pictures vary depending on the image quality or the image size. For details, see page 49.

- 1 Open the LCD panel.

- 2 Insert the “Memory Stick Duo” into the Memory Stick Duo slot in the right direction until it clicks.

Step 5: Inserting a tape or a “Memory Stick Duo” (Continued)

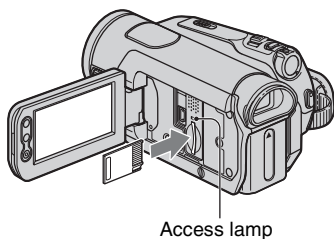

To eject a “Memory Stick Duo”

Lightly push the “Memory Stick Duo” in once.

🔌 Notes

- When the access lamp is lit or flashing, your camcorder is reading/writing data. Do not shake or knock your camcorder, turn the power off, eject the “Memory Stick Duo,” or remove the battery pack. Otherwise, image data may be damaged.
- If you force the “Memory Stick Duo” into the slot in the wrong direction, the “Memory Stick Duo,” the Memory Stick Duo slot, or image data may be damaged.
- When inserting or ejecting the “Memory Stick Duo,” be careful that the “Memory Stick Duo” does not pop out and drop.



Easy Recording/Playback (Easy Handycam)

With this Easy Handycam operation, most of the camera settings are automatically optimally adjusted, which frees you from detailed adjustments. The screen font size increases for easy viewing.

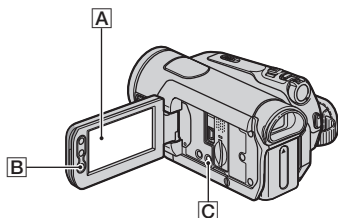

E If the POWER switch is set to OFF (CHG), slide it while pressing the green button.

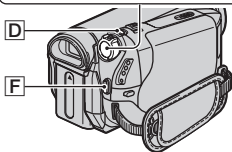

Movies



- Slide the POWER switch **E** to turn on the CAMERA-TAPE lamp.

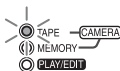

- Press EASY **C**.

EASY **EASY** appears on the screen



A.

- Press START/STOP **F** or **B** to start recording.

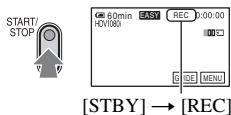

To stop recording, press **F** or **B** again.

Still images



- Slide the POWER switch **E** to turn on the CAMERA-MEMORY lamp.



- Press EASY **C**.

EASY **EASY** appears on the screen



A.

- Press PHOTO **D** to record.*

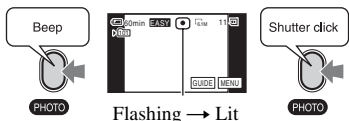

Press and hold lightly to adjust the focus. Press fully to record.

* Still images are recorded in [FINE] quality on a "Memory Stick Duo."

Playing back movies/still images

Slide the **POWER** switch **[E]** to turn on the **PLAY/EDIT** lamp. Touch the buttons on the touch panel **[A]** as follows.



Movies

Touch **[<<CB]** to rewind, then touch **[▶▶]** to start playback.

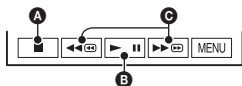

- A** Stop
- B** Play/Pause toggles
- C** Rewind/Fast forward

Still images

Touch **[MEMORY]** → **[−/ +]** to select a picture.

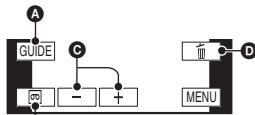

- A** GUIDE (p. 31)
- B** Tape playback
- C** Previous/Next
- D** Delete (p. 69)

■ To cancel Easy Handycam operation

Press **EASY** **[C]** again. **[EASY]** disappears from the screen.

■ Adjustable menu settings during Easy Handycam operation

Touch **[MENU]** to display adjustable menu settings. See page 39 for details on settings.

- Almost all the settings return to their default settings automatically (p. 40).
- **[P-MENU]** is not displayed during Easy Handycam operation.
- Cancel Easy Handycam operation if you want to add any effects or settings to the images.

■ Unavailable buttons during Easy Handycam

During Easy Handycam operation, the following buttons/dial are unavailable. [Invalid during Easy Handycam operation] may appear if operations not available during Easy Handycam are attempted.

- **[LAMP]** (back light) button (p. 27)
- Pressing and holding **[DISPLAY/BATT INFO]** button (p. 18)
- **[CAM CTRL]** dial (p. 26)
- **[MANUAL]** button (p. 26)

Recording

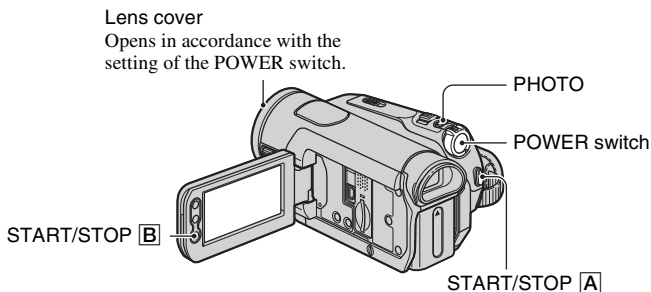

Recording movies



Movies are recorded on a tape.

- 1 Slide the POWER switch in the direction of the arrow repeatedly to turn on the CAMERA-TAPE lamp.

If the POWER switch is set to OFF (CHG), slide it while pressing the green button.

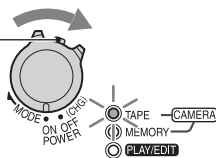

- 2 Press START/STOP [A] (or [B]).

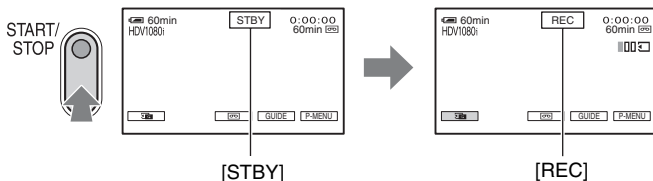

To stop recording, press START/STOP [A] (or [B]) again.

Tips

- The pictures are recorded in the HDV format in the default setting (p. 57).

To record high quality still images during tape recording (Dual Rec)

See page 25 for details.

Recording still images



Still images are recorded on the “Memory Stick Duo.”

- 1 Slide the **POWER** switch in the direction of the arrow repeatedly to turn on the **CAMERA-MEMORY** lamp.

If the **POWER** switch is set to **OFF (CHG)**, slide it while pressing the green button.

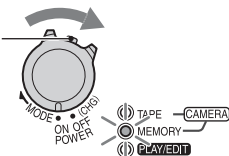

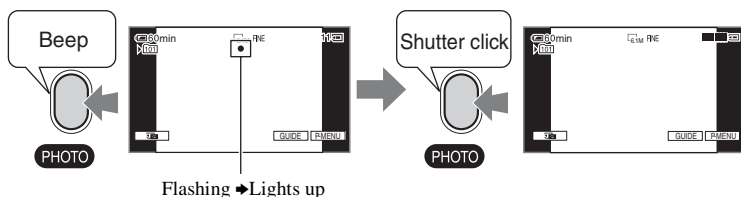

- 2 Press and hold **PHOTO** lightly to adjust the focus, then press it fully to record.



A shutter sound is heard. When  disappears, the image has been recorded.

To check the latest recording on a “Memory Stick Duo”

Touch . To delete the picture, touch  → [YES].

Tips

- See page 49 for the image quality, image size and the number of recordable pictures.

Zooming

You can magnify images to 10 times the original size with the power zoom lever or the zoom buttons on the LCD panel.

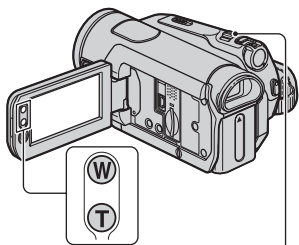

Power zoom lever

Wider range of view: (Wide angle)

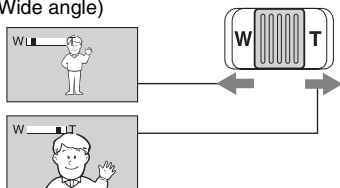

Close view: (Telephoto)

Move the power zoom lever slightly for a slower zoom. Move it further for a faster zoom.

Notes

- Be sure to keep your finger on the power zoom lever. If you move your finger off the power zoom lever, the operation sound of the power zoom lever may also be recorded.
- You cannot change the zoom speed with the zoom buttons on the LCD panel.
- The minimum possible distance between camcorder and subject while maintaining sharp focus is about 1 cm (about 13/32 in.) for wide angle and about 80 cm (about 2 5/8 feet) for telephoto.

Tips

- You can set [DIGITAL ZOOM] (p. 48) if you want to zoom to a level greater than 10 x.

Recording high quality still images during tape recording (Dual Rec)

You can record high quality still images on the “Memory Stick Duo” during tape recording.

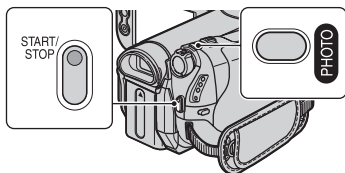

- ① Slide the POWER switch to turn on the CAMERA-TAPE lamp, then press START/STOP to start tape recording.
- ② Press PHOTO fully.

For each separate time tape recording, up to 3 still images can be recorded.



Orange color boxes indicate the number of recorded images. When recording is finished, the color changes to orange.

- ③ Press START/STOP to stop tape recording. Stored still images appear one by one, and the images are stored onto the “Memory Stick Duo.” When  disappears, the image has been recorded.

Notes

- Do not eject the “Memory Stick Duo” before tape recording is finished and the still images are stored on the “Memory Stick Duo.”
- You cannot use the flash during Dual Rec.

Tips

- During the standby mode, still images will be stored in the same way as when the POWER switch is set to CAMERA-MEMORY. You can use the flash.

Recording (Continued)

- When the POWER switch is set to CAMERA-TAPE, still images will be recorded at image size 4.6M in the HDV format, 3.4M (4:3) or 4.6M (16:9) in the DV format.

Controlling the image settings manually with the CAM CTRL dial

It is useful to assign a frequently used menu item to the CAM CTRL dial.

The following is an example of the procedure when the [FOCUS] setting is assigned (the default setting).

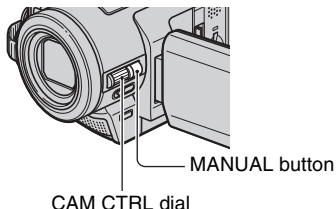

- ① Press the MANUAL button to activate the manual adjustment mode.
The setting mode switches between automatic and manual every time you press the MANUAL button.
- ② Rotate the CAM CTRL dial to adjust the focus manually.

Menu items that can be assigned

- [FOCUS] (p. 45)
- [EXPOSURE] (p. 43)
- [SHUTTR SPEED] (p. 44)
- [AE SHIFT] (p. 45)
- [WB SHIFT] (p. 45)

To assign the menu items to the CAM CTRL dial

- ① Press and hold the MANUAL button for several seconds.
The [DIAL SET] screen appears.

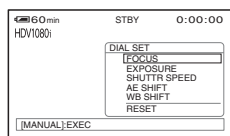

- ② Rotate the CAM CTRL dial and select a menu item to be assigned.
- ③ Press the MANUAL button.

Notes

- The menu item settings done before will be retained even if you set other menu item settings after that. If [EXPOSURE] is set after [AE SHIFT] is set manually, [EXPOSURE] will override [AE SHIFT].
- If you select [RESET] in step ②, all the settings set manually return to the default setting.

Tips

- During playback, you can adjust the volume using the CAM CTRL dial.
- You can also assign menu items using [DIAL SET] (p. 49).

Using the flash

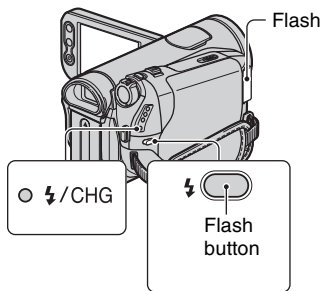

Press the ⚡ (flash) button repeatedly to select an appropriate setting.

No indication (Auto flash): Automatically flashes when there is insufficient ambient light.



⚡ (Forced flash): Always uses the flash regardless of the surrounding brightness.



Ⓜ (No flash): Records without flash.

⚡ Notes

- Remove the lens hood when you use the flash, or its shadow will appear in the picture.
- The recommended distance to the subject when using the built-in flash is 0.3 to 2.5 m (1 to 8 feet).
- Remove any dust from the surface of the flash lamp before using it. Flash effect may be impaired if heat discoloration or dust obscures the lamp.
- The $\frac{1}{2}$ /CHG (charge) lamp flickers when charging the flash, and remains lit when the flash charge is ready. (In [STBY] of the CAMERA-TAPE mode, it takes a while to fully charge the flash.)
- You cannot use the flash during tape recording.
- If you use the flash in bright places such as when shooting a backlit subject, the flash may not be effective.

💡 Tips

- You can change the brightness of the flash by setting [FLASH LEVEL], or you can prevent the redeye by setting [REDEYE REDUC], in [FLASH SET] (p. 46).

Recording in dark places (NightShot)

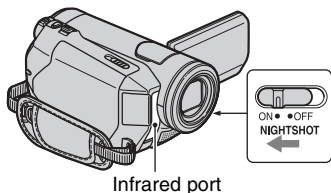

Set the NIGHTSHOT switch to ON (👁) and ["NIGHTSHOT"] appear).

⚡ Notes

- The NightShot and Super NightShot functions use infrared light. Therefore, do not cover the infrared port with your fingers or other objects and remove the conversion lens (optional) and the lens hood.

- Adjust the focus manually ([FOCUS], p. 45) when it is hard to focus automatically.
- Do not use these functions in bright places. This may cause a malfunction.

💡 Tips

- To record an image brighter, use Super NightShot function (p. 47). To record an image more faithful to the original colors, use Color Slow Shutter function (p. 47).

Adjusting the exposure for backlit subjects

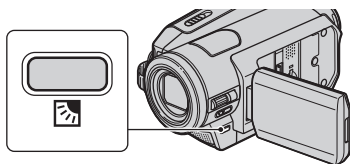

To adjust the exposure for backlit subjects, press (back light) to display . To cancel the backlight function, press (back light) again.

Recording in mirror mode

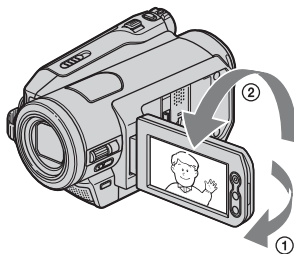

Open the LCD panel 90 degrees to the camcorder (①), then rotate it 180 degrees to the lens side (②).

💡 Tips

- A mirror-image of the subject appears on the LCD screen, but the picture will be normal when recorded.

Playback

Slide the **POWER** switch in the direction of the arrow repeatedly to turn on the **PLAY/EDIT** lamp.

If the **POWER** switch is set to **OFF (CHG)**, slide it while pressing the green button.

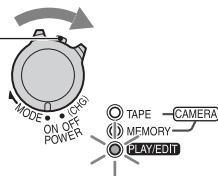

Playing movies



Touch to rewind to the desired scene, then touch to start playback.

Toggles Play or Pause as you touch*

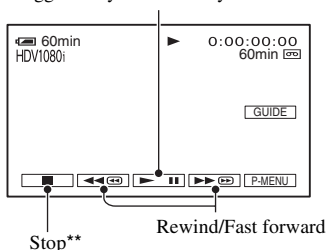

* Playback automatically stops if pause is engaged for more than 3 minutes.

** **MEMORY** is displayed instead of when a "Memory Stick Duo" with recorded images is inserted and a tape is not being played.

To adjust the sound volume

Rotate the **CAM CTRL** dial to adjust the volume manually (p. 26).

Tips

- You can also adjust the volume from the menu (p. 58).

To search for a scene during playback

Touch and hold / during playback (Picture Search), or / while fast forwarding or rewinding the tape (Skip Scan).

Tips

- You can play back in various modes ([] VAR.SPD PB], p. 55).

Viewing still images



Touch **MEMORY**.

The most recently recorded image is displayed.

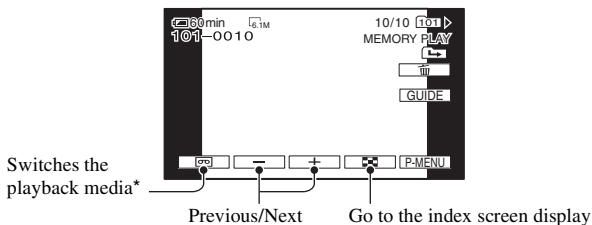

* **MEMORY** is displayed on the tape playback screen.

To display pictures on a “Memory Stick Duo” on the Index screen

Touch . Touch one of the pictures to back to the single display mode.

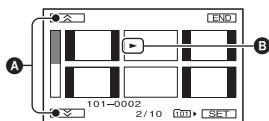

- A** Previous/Next 6 pictures
- B** The picture displayed before switching to the index screen

To view pictures in other folders, touch → **SET** → **[PB FOLDER]**, select a folder with /, then touch **OK** (p. 51).

Using PB zoom

You can magnify images from about 1.1 to 5 times (from about 1.5 to 5 times in still images) the original size.

Magnification can be adjusted with the power zoom lever or the zoom buttons on the LCD panel.

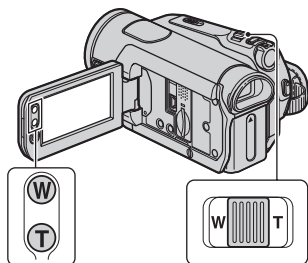

- ① Play back the picture you want to magnify.
- ② Magnify the picture with T (Telephoto).
- ③ Touch the screen at the point you want to display in the center of the displayed frame.
- ④ Adjust the magnification with W (Wide angle)/T (Telephoto).

To cancel, touch [END].

Using the guide functions (USAGE GUIDE)

You can easily select the desired setting screens by using the guide functions (USAGE GUIDE).

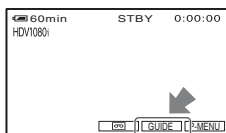

Your camcorder has 4 guide functions as shown below.

SHOOT GUIDE:	Takes you to the setting screens related to recording.
CONNECT GUIDE:	Recommends the appropriate connection method for your device. For details, see page 34.
USEFUL GUIDE:	Takes you to the setting screens related to the basic operations.
DISP GUIDE:	Enables you to check the meaning of each indicator that appears on the LCD screen. See page 110 for details.

Unavailable settings during Easy Handycam

During Easy Handycam operation, some items are unavailable. If an attempted setting is not available, but still desired, touch [SET] to display an on-screen instruction. Follow the instruction to cancel Easy Handycam operation and then select the setting.



💡 Tips

- If [SET] is not displayed in step 3, follow the instruction on the screen.

1 Touch [GUIDE].

2 Select the desired item.

e.g., to record night views

Touch [SHOOT GUIDE] → [SELECT SCENE] → / to display [To keep the mood of a night view].

3 Touch [SET].

The desired setting screen appears.

Adjust the settings according to your purpose.

Searching for the starting point

Searching for the last scene of the most recent recording (END SEARCH)

END SEARCH will not work once you eject the cassette after you have recorded on the tape.

Make sure that the CAMERA-TAPE lamp lights up (p. 23).

Touch  → .

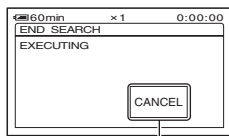

Touch here to cancel the operation.

The last scene of the most recent recording is played back for about 5 seconds, and the camcorder enters the standby mode at the point where the last recording has finished.

Notes

- END SEARCH will not work correctly when there is a blank section between recorded sections on the tape.

Tips

- You can also select [END SEARCH] from the menu. When the PLAY/EDIT lamp lights up, select the [END SEARCH] short-cut in Personal Menu (p. 39).

Reviewing the most recently recorded scenes (Rec review)

You can view about 2 seconds of the scene recorded just before you stopped the tape.

Make sure that the CAMERA-TAPE lamp lights up (p. 23).

Touch  → .

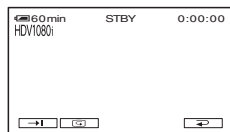

The last 2 seconds (approx.) of the most recently recorded scene are played back. Then, your camcorder is set to standby.

Searching quickly for a desired scene (Zero set memory)

Slide the POWER switch repeatedly to turn on the PLAY/EDIT lamp, then operate the Remote Commander (p. 28).

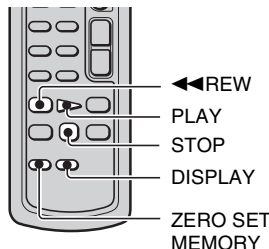

1 During playback, press ZERO SET MEMORY on the Remote Commander at a point you want to locate later on.

The tape counter is reset to "0:00:00" and **→0+** appears on the screen.

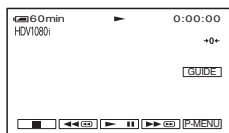

If the tape counter is not displayed, press DISPLAY.

2 Press STOP when you want to stop playback.

3 Press ◀◀REW.

The tape stops automatically when the tape counter reaches "0:00:00."

The tape counter returns to the time code display, and the zero set memory display disappears.

4 Press PLAY.

Playback starts from the point designated "0:00:00" on the tape counter.

To cancel the operation

Press ZERO SET MEMORY again before rewinding.

⚙ Notes

- There may be a discrepancy of several seconds between the time code and the tape counter.

- Zero set memory will not function correctly if there is a blank section between recorded sections on the tape.

Searching for a scene by date of recording (Date search)

You can locate the point where the recording date changes.

Slide the POWER switch repeatedly to turn on the PLAY/EDIT lamp (p. 28).

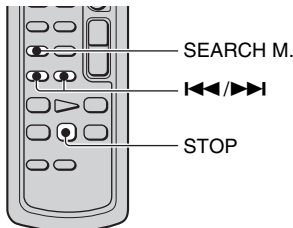

1 Press SEARCH M. on the Remote Commander.

2 Press ◀◀ (Previous)/▶▶ (Next) to select a recording date.

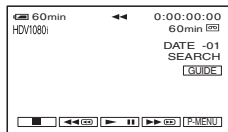

To cancel the operation

Press STOP.

⚙ Notes

- The Date search will not function correctly when there is a blank section between recorded sections on the tape.

Playing the picture on a TV

Connection methods and image quality differ depending on what type of TV is connected and connectors used.

Use the supplied AC Adaptor as the power source (p. 13).

Refer also to the instruction manuals supplied with the device to be connected.

Notes

- Make all menu settings on your camcorder before connecting. The TV may not recognize the video signal properly if the [VCR HDV/DV] or [i.LINK CONV] setting is changed after the TV and your camcorder were connected with an i.LINK cable.
- Pictures recorded in the DV format are played back as SD (standard definition) images regardless of the connection.
- When recording, set [X.V.COLOR] to [ON] to play back on an x.v.Color-compliant TV (p. 49). Some settings may need to be adjusted on the TV when playing back.

Jacks on your camcorder

Open the jack cover in the direction of the arrow and connect the cable.

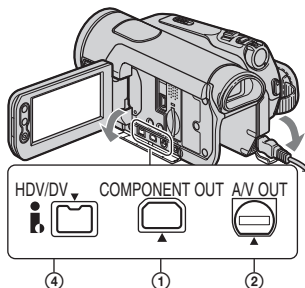

Lift up the bottom of the jack cover, then rotate in the direction of the arrow.

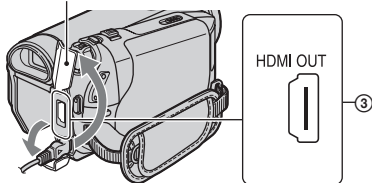

Selecting the appropriate connection method (CNECT GUIDE)

Your camcorder helps you select the appropriate connection for your device. The output setting of your camcorder is then set automatically.

1 Touch [GUIDE].

2 Touch [CNECT GUIDE].

3 Connect your camcorder and TV according to the instructions on the LCD screen.

An example of connecting to a high definition TV

- 1 Touch [TV] → [HD TV].
- 2 Select the TV input jacks with [←]/[→], then touch [OK].
- 3 Check the output setting details, then touch [OK].
- 4 Connect your camcorder and TV, referring to the picture on the screen. Touch [HINT] and refer also to the precautions on connecting.
- 5 Touch [OK] → [END].

Tips

- To return to the previous question, touch [↶].

Connecting to a high definition TV

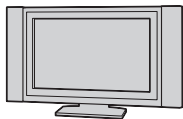

HD (high definition) image quality

- An HDV formatted picture is played back as it is (HD image quality).
- A DV formatted picture is played back as it is (SD image quality).

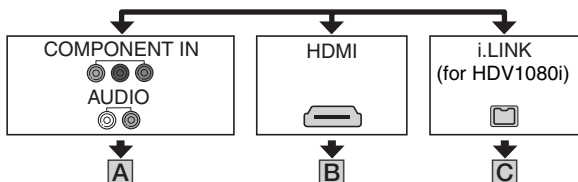

: Signal flow, () : Reference pages

Type	Camcorder	Cable	TV	Menu Setting
------	-----------	-------	----	--------------

A



①
Component video cable (supplied)

COMPONENT VIDEO IN

(STANDARD SET)
 [VCR HDV/DV] →
 [AUTO] (56)
 [COMPONENT] →
 [1080i/480i] (59)



②
A/V connecting cable (supplied)

AUDIO

- An A/V connecting cable is also needed to output audio signals. Connect the white and red plugs of the A/V connecting cable to the audio input jack of your TV.

Playing the picture on a TV (Continued)

↗ : Signal flow, () : Reference pages

Type	Camcorder	Cable	TV	Menu Setting
------	-----------	-------	----	--------------

B

③



HDMI cable (optional)



HDMI IN



(STANDARD SET)
[VCR HDV/DV] →
[AUTO] (56)

- Use an HDMI cable with the HDMI logo (on the front cover).
- Pictures in the DV format are not output from the HDMI OUT jack, if copyright protection signals are recorded in the pictures.
- DV format pictures input to the camcorder via i.LINK cable (p. 67) cannot be output.
- Your TVs may not function correctly (e.g., no sound or image). Do not connect the HDMI OUT jack of your camcorder and HDMI OUT jack of an external device with the HDMI cable. This may cause a malfunction.

C

④



i.LINK cable (supplied)



i.LINK



(STANDARD SET)
[VCR HDV/DV] →
[AUTO] (56)
[i.LINK CONV] →
[OFF] (59)

- Your TV needs to have an i.LINK jack compatible with HDV1080i specification. For details, confirm the specifications of your TV.
- If your TV is not compatible with HDV1080i specification, connect your camcorder and TV with the supplied component video cable and A/V connecting cable as illustrated in **A**.
- The TV needs to be set so that it recognizes that the camcorder is connected. See the instruction manuals supplied with your TV.

Connecting to a 16:9 (wide) or 4:3 TV

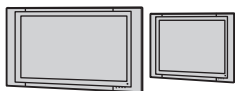

SD (standard definition) image quality

- An HDV formatted picture is down converted to DV format (SD image quality) and played back.
- A DV formatted picture is played back as it is (SD image quality).

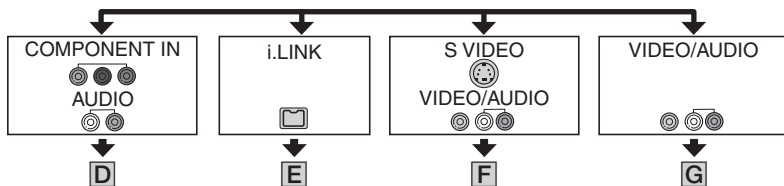









To set the aspect ratio according to the connected TV (16:9/4:3)

Change the [TV TYPE] setting to match your TV (p. 59).

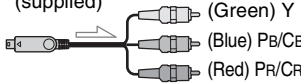

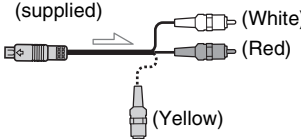

Notes

- When you play back a tape recorded in the DV format on a 4:3 TV not compatible with the 16:9 signal, set [WIDE SELECT] to [4:3] on your camcorder when recording a picture (p. 57).

 : Signal flow, () : Reference pages

Type	Camcorder	Cable	TV	Menu Setting
D		<p>Component video cable (supplied)</p>  <p>(Green) Y (Blue) PB/Cb (Red) PR/Cr</p>	<p>COMPONENT VIDEO IN</p> 	<p> (STANDARD SET) [VCR HDV/DV] → [AUTO] (56) [COMPONENT] → [480i] (59) [TV TYPE] → [16:9]/[4:3] (59)</p>
		<p>A/V connecting cable (supplied)</p>  <p>(White) (Red) (Yellow)</p>	<p>AUDIO</p> 	







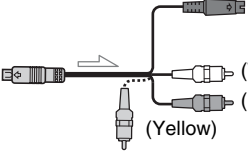
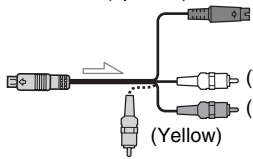

- A/V connecting cable is also needed to output audio signals. Connect the white and red plugs of the A/V connecting cable to the audio input jack of your TV.

E		<p>i.LINK cable (supplied)</p> 	<p>i.LINK</p> 	<p> (STANDARD SET) [VCR HDV/DV] → [AUTO] (56) [i.LINK CONV] → [ON HDV → DV] (59)</p>
----------	--	---	--	---

- The TV needs to be set so that it recognizes that the camcorder is connected. See the instruction manuals supplied with your TV.

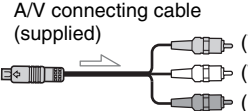
Playing the picture on a TV (Continued)

↗ : Signal flow, () : Reference pages

Type	Camcorder	Cable	TV	Menu Setting
F		A/V connecting cable with S VIDEO (optional) 	S VIDEO  VIDEO  AUDIO 	(STANDARD SET) [VCR HDV/DV] → [AUTO] (56) [TV TYPE] → [16:9]/[4:3] (59)
G		A/V connecting cable (supplied) 	(Yellow) VIDEO  (White) VIDEO  (Red) AUDIO 	(STANDARD SET) [VCR HDV/DV] → [AUTO] (56) [TV TYPE] → [16:9]/[4:3] (59)

- When connecting only an S VIDEO plug (S VIDEO channel), audio signals are not output. To output audio signals, connect the white and red plugs of the A/V connecting cable with an S VIDEO cable to the audio input jack of your TV.
- This connection produces higher resolution pictures compared with the A/V connecting cable (Type **G**).

When connecting to your TV via a VCR

Select one of the connecting methods on page 64, according to the input jack of the VCR. Connect your camcorder to the LINE IN input on the VCR using the A/V connecting cable. Set the input selector on the VCR to LINE (VIDEO 1, VIDEO 2, etc.).

When your TV is monaural (When your TV has only one audio input jack)

Connect the yellow plug of the A/V connecting cable to the video input jack and connect the white (left channel) or the red (right channel) plug to the audio input jack of your TV or VCR.

On "PhotoTV HD"

This camcorder is compatible with the "PhotoTV HD" standard. "PhotoTV HD" allows for highly-detailed, photo-like depiction of subtle textures and colors. By

connecting Sony's PhotoTV HD-compatible devices using an HDMI cable* or component video cable**, a whole new world of photos can be enjoyed in breathtaking full HD quality.

* The TV will automatically switch to the appropriate mode when displaying photos.

** Setup of the TV will be necessary.

Please refer to the instruction manual of your PhotoTV HD-compatible TV for details.

Tips

- The HDMI (High Definition Multimedia Interface) is an interface to send both video/ audio signals. Connecting HDMI OUT jack and external device with a cable supplies high quality images and digital audio.
- If you connect your camcorder to your TV using more than one type of cable to output images from a jack other than the i.LINK jack, the order of priority of the output signals is as follows: HDMI → component video → S VIDEO → audio/video.
- See page 95 for the details of i.LINK.

Using the menu items

- 1** Slide the **POWER** switch in the direction of the arrow repeatedly to turn on the respective lamp.

CAMERA-TAPE lamp:  settings on a tape

CAMERA-MEMORY lamp:  settings on a "Memory Stick Duo"

PLAY/EDIT lamp: settings for viewing/editing

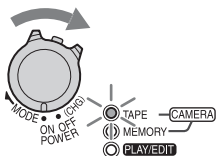

- 2** Touch the LCD screen to select the menu item.

Unavailable items will be grayed out.

■ To use the short-cuts of Personal Menu



On Personal Menu, short-cuts for frequently used menu items are added.

💡 Tips

- You can customize Personal Menu as you like (p. 62).

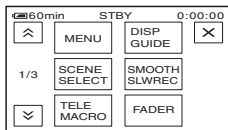
- ① Touch **P-MENU**.





- ② Touch the desired item.
If the desired item is not displayed on the screen, touch / until the item is displayed.
- ③ Select the desired setting, then touch **OK**.

■ To use menu items

You can customize menu items that are not added to Personal Menu.

- ① Touch **P-MENU** → [MENU].
- ② Select the desired menu.

Touch / to select the item, then touch **OK** (The process in step ③ is the same as that in step ②).

- ③ Select the desired item.
- ④ Customize the item.

After finishing the settings, touch **OK** →  (close) to hide the menu screen.

If you decide not to change the setting, touch  to return to the previous screen.

■ To use menu items during Easy Handycam operation

P-MENU is not displayed during Easy Handycam operation. Touch [MENU] to display the menu index screen.

Menu items



Available menu items (●) vary depending on which lamp is lit. During Easy Handycam operation, the setting is set automatically as shown in the following list.

Position of lamp: **TAPE** **MEMORY** **PLAY/EDIT** **Easy Handycam**

CAMERA SET menu (p. 42)

SCENE SELECT	●	●	—	AUTO
SPOT MTR-FCS	●	●	—	—
SPOT METER	●	●	—	—
EXPOSURE	●	●	—	AUTO
WHITE BAL.	●	●	—	AUTO
SHARPNESS	●	●	—	—
SHUTTR SPEED	●	●	—	AUTO
AUTOSLW SHTR	●	—	—	ON
AE SHIFT	●	●	—	OFF
CAMERA COLOR	●	●	—	—
WB SHIFT	●	●	—	OFF
SPOT FOCUS	●	●	—	AUTO
FOCUS	●	●	—	AUTO
TELE MACRO	●	●	—	OFF
PEAKING	●	●	—	OFF
FLASH SET	●	●	—	½*/OFF
SUPER NS	●	—	—	OFF
NS LIGHT	●	●	—	ON
COLOR SLOW S	●	●	—	OFF
ZEBRA	●	●	—	OFF
HISTOGRAM	●	●	—	OFF
SELF-TIMER	●	●	—	●*2
DIGITAL ZOOM	●	—	—	OFF
STEADYSHOT	●	●	—	ON
CONV.LENS	●	●	—	—*1
DIAL SET	●	●	—	—
X.V.COLOR	●	—	—	—*1

MEMORY SET menu (p. 49)



STILL SET	—	●	●	FINE/●*1
 ALL ERASE	—	—	●	●
 FORMAT	—	●	●	—
FILE NO.	—	●	●	—*1
NEW FOLDER	—	●	●	—
REC FOLDER	—	●	●	—*1
PB FOLDER	—	—	●	—*1

PICT.APPLI. menu (p. 52)

FADER	●	—	—	OFF
INT.REC-STL	—	●	—	OFF
SLIDE SHOW	—	—	●	—
D.EFFECT	●	—	●	OFF
PICT.EFFECT	●	—	●	OFF

	Position of lamp:	TAPE	MEMORY	PLAY/EDIT	Easy Handycam
SMTH SLW REC		●	–	–	–
PictBridge PRINT		–	–	●	–
USB SELECT		–	–	●	–
DEMO MODE		●	–	–	ON

EDIT/PLAY menu (p. 55)

 VAR.SPD PB	–	–	●	–
 REC CTRL	–	–	●	–
END SEARCH	●	–	●	–

STANDARD SET menu (p. 56)

VCR HDV/DV	–	–	●	AUTO
REC FORMAT	●	–	–	●*1
DV SET DV	●	–	●	SP*1/16:9 WIDE*1/ 16b*1/ _ *1
VOLUME	●	●	●	●*1*3
MIC LEVEL	●	–	–	AUTO
LCD/VF SET	●	●	●	– /NORMAL/ – / NORMAL
COMPONENT	●	●	●	1080i/480i*1
i.LINK CONV	●	–	●	OFF*1
TV TYPE	●	●	●	16:9*1
DISP GUIDE	●	●	●	●
STATUS CHECK	●	–	●	–
GUIDEFAME	●	●	–	OFF
CENTER MARKR	●	●	–	OFF
COLOR BAR	●	–	–	OFF
DATA CODE	–	–	●	●
 REMAINING	●	–	●	AUTO
REMOTE CTRL	●	●	●	ON
REC LAMP	●	●	–	ON
BEEP	●	●	●	●*1
DISP OUTPUT	●	●	●	LCD PANEL
MENU ROTATE	●	●	●	–
A.SHUT OFF	●	●	●	5min
CALIBRATION	–	–	●	–
QUICK REC HDV1080i	●	–	–	OFF

TIME/LANGU. menu (p. 62)

CLOCK SET	●	●	●	●*1
WORLD TIME	●	●	●	_ *1
LANGUAGE	●	●	●	_ *1

*1 The setting value before entering Easy Handycam operation will be retained.

*2 Cannot be operated in the CAMERA-TAPE mode.

*3 Available only when the POWER switch is set to PLAY/EDIT.

CAMERA SET menu

Settings to adjust your camcorder to the recording conditions

The default settings are marked with ►.
The indicators in parentheses appear when the items are selected.

See page 39 for details on selecting menu items.

SCENE SELECT

You can record pictures effectively in various situations with the [SCENE SELECT] function.

► AUTO

Select to automatically record pictures effectively without the [SCENE SELECT] function.

TWILIGHT* (☾)

Select to maintain the darkening atmosphere of the distant surroundings in twilight scenes.



TWILIT PORTRT (Twilight portrait) (☾)

Select to photograph people and background using the flash when recording still images.



CANDLE (🕯)

Select to maintain the dim atmosphere of a candlelit scene.



SUNRSE SUNSET (Sunrise and sunset)* (☀)

Select to maintain the atmosphere of situations such as sunsets and sunrises.



FIREWORKS* (🎆)

Select to record all the splendor of fireworks.



LANDSCAPE* (🏞)

Select to shoot distant subjects clearly. This setting also prevents your camcorder from focusing on glass or metal mesh in windows between the camcorder and the subject.



PORTRAIT (Soft portrait) (👤)

Select to bring out the subject such as people or flowers while creating a soft background.



SPOTLIGHT** (🎤)

Select to prevent people's faces from appearing excessively white when subjects are lit by strong light.



BEACH** (🏖)

Select to prevent people's faces from appearing dark in strong light or reflected light, such as at a beach in midsummer.



SNOW** (❄)

Select this when shooting in very bright, white conditions, such as on a ski slope; otherwise picture may appear too dark.



- * Adjusted to focus on subjects farther away only.
- ** Adjusted not to focus on subjects a short distance away.

Notes

- If you set [SCENE SELECT], the settings of [SHUTTR SPEED] and [WHITE BAL.] are canceled.

SPOT MTR·FCS (Spot Meter & Spot Focus)

You can adjust the brightness and the focus of a picture at the same time.

You can use the functions [SPOT METER] (p. 43) and [SPOT FOCUS] (p. 45) at the same time.

- 1 Touch the point on the screen where you want to adjust and fix the exposure and the focus.

←→ and  appear.



- 2 Touch [END].

To return the setting to automatic exposure and focus, touch [AUTO]→[END].

Notes

- If you set [SPOT MTR·FCS], [EXPOSURE] and [FOCUS] are automatically set to [MANUAL].

SPOT METER (Flexible spot meter)

You can adjust and fix the exposure to the subject, so that it is recorded in suitable brightness even when there is strong contrast between the subject and the background, such as subjects in the spotlight on stage.

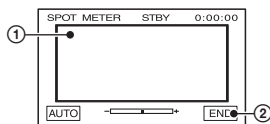

- 1 Touch the point where you want to fix and adjust the exposure on the screen.

←→ appears.

- 2 Touch [END].

To return the setting to automatic exposure, touch [AUTO] → [END].

Notes

- If you set [SPOT METER], [EXPOSURE] is automatically set to [MANUAL].

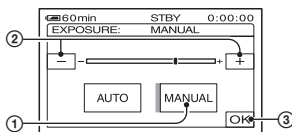

EXPOSURE

You can fix the brightness of a picture manually. Adjust the brightness when the subject is much brighter or darker than the background.



- 1 Touch [MANUAL].

←→ appears.

- 2 Adjust the exposure by touching  / .

- 3 Touch [OK].

To return the setting to automatic exposure, touch [AUTO] → [OK].

Tips

- You can also adjust the setting manually using the CAM CTRL dial (p. 26).

WHITE BAL. (White balance)

You can adjust the color balance to the brightness of the recording environment.

▶ AUTO

The white balance is adjusted automatically.

OUTDOOR (☀)

The white balance is appropriately adjusted for the following recording conditions:

- Outdoors
- Night views, neon signs and fireworks
- Sunrise or sunset
- Under daylight fluorescent lamps

INDOOR (☾)

The white balance is appropriately adjusted for the following recording conditions:

- Indoors
- At party scenes or studios where the lighting conditions change quickly
- Under video lamps in a studio, or under sodium lamps or incandescent-like color lamps

ONE PUSH (📷)

The white balance will be adjusted according to the ambient light.

- ① Touch [ONE PUSH].
- ② Frame a white object such as a piece of paper, to fill the screen under the same lighting conditions as you will shoot the subject.
- ③ Touch [📷].
📷 flashes quickly. When the white balance has been adjusted and stored in the memory, the indicator stops flashing.

🔊 Notes

- Set [WHITE BAL.] to [AUTO] or adjust the color in [ONE PUSH] under white or cool white fluorescent lamps.
- When you select [ONE PUSH], keep framing white objects while 📷 is flashing quickly.
- 📷 flashes slowly if [ONE PUSH] could not be set.
- When [ONE PUSH] was selected, if 📷 keeps flashing after touching [OK], set [WHITE BAL.] to [AUTO].
- If you set [WHITE BAL.], [SCENE SELECT] returns to [AUTO].

💡 Tips

- If you have changed the battery pack while [AUTO] was selected, or taken your camcorder outdoors after inside use (or vice versa), select [AUTO] and aim your camcorder at a nearby white object for about 10 seconds for better color balance adjustment.
- When the white balance has been set with [ONE PUSH], if you change the [SCENE SELECT] settings, or bring your camcorder outdoors from inside the house, or vice versa, you need to redo the [ONE PUSH] procedure to readjust the white balance.

SHARPNESS

You can adjust the sharpness of the image outline with / . appears when the sharpness is anything other than the default setting.



SHUTTR SPEED

You can manually adjust and fix the shutter speed for your convenience. Depending on the shutter speed, you can make the subject look still, or emphasize movement of the subject.

▶ AUTO

Select to adjust the shutter speed automatically.

MANUAL (S)

Adjust the shutter speed using / .

You can select a shutter speed between 1/4 and 1/10000 second when the POWER switch is set to CAMERA-TAPE, and between 1/4 and 1/500 second when the POWER switch is set to CAMERA-MEMORY.



Notes

- When the shutter speed is set between 1/725 to 1/10000 second, still images cannot be recorded.
- For example, if you select 1/100 second, [100] appears on the screen.
- At a slow shutter speed, automatic focus may be lost. Adjust the focus manually, using a tripod, etc.
- When recording under a discharge tube such as a fluorescent lamp, sodium lamp or mercury lamp, horizontal bands may appear in the screen depending on the shutter speed.

Tips

- You can also adjust the setting manually using the CAM CTRL dial (p. 26).

AUTOSLW SHTR (Auto slow shutter)

When you set [AUTOSLW SHTR] to [ON], the shutter speed is slowed down automatically to 1/30 second in dark places.

AE SHIFT

You can adjust the exposure using $\boxed{-}$ (dark)/ $\boxed{+}$ (bright). **AS** and the setting value appear when [AE SHIFT] is anything other than the default setting.

Tips

- Touch $\boxed{+}$ if the subject is white or the backlight is bright, or touch $\boxed{-}$ if the subject is black or the light is dim.
- You can adjust the automatic exposure level to brighter or darker when [EXPOSURE] is set to [AUTO].
- You can also adjust the setting manually using the CAM CTRL dial (p. 26).

CAMERA COLOR

You can adjust the color intensity with $\boxed{-}$ / $\boxed{+}$. **C** appears when [CAMERA COLOR] is anything other than the default setting.

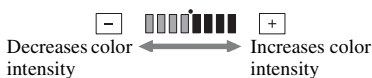

Decreases color intensity

Increases color intensity

WB SHIFT (White Balance Shift)

You can adjust the white balance to the desired setting using $\boxed{-}$ / $\boxed{+}$. **WS** and the setting value appear when [WB SHIFT] is anything other than the default setting.

Tips

- When the white balance is set to a lower value, pictures appear bluish, and when set to a higher value, pictures appear reddish.
- You can also adjust the setting manually using the CAM CTRL dial (p. 26).

SPOT FOCUS

You can select and adjust the focal point to a subject not located in the center of the screen.

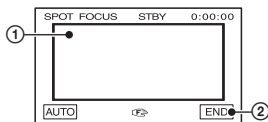

- ① Touch the subject on the screen.

CF appears.

- ② Touch [END].

To adjust the focus automatically, touch [AUTO] → [END].







Notes

- If you set [SPOT FOCUS], [FOCUS] is automatically set to [MANUAL].

FOCUS

You can adjust the focus manually. You can select this function also when you want to focus on a certain subject intentionally.



- ① Touch [MANUAL].
 appears.
- ② Touch  (focusing on close subjects)/
 (focusing on distant subjects) to
 sharpen the focus.  appears when the
 focus cannot be adjusted any closer, and  appears
 when the focus cannot be adjusted farther away.
 If you touch , ∞ appears, and you
 can adjust the focus to infinity.
- ③ Touch [OK].

To adjust the focus automatically, touch
 [AUTO] → [OK].

Notes

- The minimum possible distance between camcorder and subject while maintaining sharp focus is about 1 cm (about 13/32 in.) for wide angle and about 80 cm (about 2 5/8 feet) for telephoto.

Tips

- It is easier to focus on the subject by moving the power zoom lever towards T (telephoto) to adjust the focus, then towards W (wide angle) to adjust the zoom for recording. When you want to record a subject at close range, move the power zoom lever to W (wide angle), then adjust the focus.
- You can also adjust the focus manually using the CAM CTRL dial (p. 26).

TELE MACRO

This is useful to shoot small subjects, such as flowers or insects. You can blur out backgrounds and the subject stands out clearer.

When you set [TELE MACRO] to [ON] () , the zoom (p. 25) moves to the top of the T (Telephoto) side automatically and allows for recording subjects at a close distance down to about 45 cm (17 3/4 in.).



To cancel, touch [OFF], or zoom to wide-angle (W side).

Notes

- When recording a distant subject, focusing may be difficult and can take some time.
- Adjust the focus manually ([FOCUS], p. 45) when it is hard to focus automatically.

PEAKING

The outline of the subject on the screen is enhanced for easier focusing. You can set the outline color displayed on the screen during peaking. If you change the default setting, ^{PEAK}_{NO} is displayed on the screen.

▶ OFF

Do not set this function.

WHITE

Makes the outline color white.

RED

Makes the outline color red.

YELLOW

Makes the outline color yellow.

Tips

- The peaking is not recorded on the tape.

FLASH SET

You can set this function when you use the built-in flash or an external flash (optional) that is compatible with your camcorder.

■ FLASH LEVEL

HIGH(++)

Makes the flash level higher.

▶ NORMAL(±)

LOW(±-)

Makes the flash level lower.



REDEYE REDUC

You can prevent redden by activating the flash before recording.

Set [REDEYE REDUC] to [ON], then press the  (flash) button (p. 26) repeatedly to select a setting.

 (Auto redden reduction): Pre-flashes to reduce redden before the flash automatically flashes when there is insufficient ambient light.



  (Forced redden reduction): Always uses the flash and the redden reducing pre-flash.



 (No flash): Records without flash.

Notes

- The redden reduction may not produce the desired effect due to individual differences and other conditions.

SUPER NS (Super NightShot)

The picture will be recorded at a maximum of 16 times the sensitivity of NightShot recording if you set [SUPER NS] to [ON] while the NIGHTSHOT switch (p. 27) is also set to ON.

 and ["SUPER NIGHTSHOT"] appear on the screen.

To return to the normal setting, set [SUPER NS] to [OFF], or set the NIGHTSHOT switch to OFF.

Notes

- Do not use NightShot/[SUPER NS] in bright places. This may cause a malfunction.
- Do not cover the infrared port with your fingers or other objects (p. 105).
- Remove the conversion lens (optional) and the lens hood.
- Adjust the focus manually ([FOCUS], p. 45) when it is hard to focus automatically.
- The shutter speed of your camcorder changes depending on the brightness. The motion of the picture may slow down in this case.

NS LIGHT (NightShot Light)

When using either the NightShot (p. 27) or [SUPER NS] (p. 47) function to record, you can record clearer pictures by setting [NS LIGHT], which emits infrared light (invisible), to [ON] (the default setting).

Notes

- Do not cover the infrared port with your fingers or other objects (p. 105).
- Remove the conversion lens (optional) and the lens hood.
- The maximum shooting distance using [NS LIGHT] is about 3 m (10 feet).

COLOR SLOW S (Color Slow Shutter)

When you set [COLOR SLOW S] to [ON], you can record an image brighter in color even in dark places.

 and [COLOR SLOW SHUTTER] appear on the screen.

To cancel [COLOR SLOW S], touch [OFF].

Notes

- Adjust the focus manually ([FOCUS], p. 45) when it is hard to focus automatically.
- The shutter speed of your camcorder changes depending on the brightness. The motion of the picture may slow down at this time.

ZEBRA

Diagonal stripes appear in portions of the screen where brightness is at a preset level. This is useful as a guide when adjusting the brightness. When you change the default setting,  is displayed. The zebra pattern is not recorded.

► OFF

The zebra pattern is not displayed.

70

The zebra pattern appears at a screen brightness level of about 70 IRE.

100

The zebra pattern appears at a screen brightness level of about 100 IRE or higher.

Notes

- Portions of the screen where brightness is about 100 IRE or higher may appear overexposed.

Tips

- IRE represents the screen brightness.

HISTOGRAM

When you set [HISTOGRAM] to [ON], the [HISTOGRAM] (a graph to display a distribution of tones in your picture) window appears on the screen.

This item is useful when you adjust exposure. You can adjust the [EXPOSURE] or [AE SHIFT] checking the [HISTOGRAM] window. The [HISTOGRAM] will not be recorded on a tape or “Memory Stick Duo.”

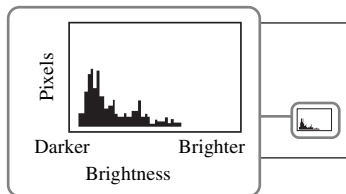

Tips

- The left area on the graph shows the darker areas of the picture while the right area shows the brighter areas.

SELF-TIMER

A still image is recorded after about 10 seconds.

Press PHOTO when [SELF-TIMER] is set to [ON] and ☺ appears.

To cancel the count down, touch [RESET].

To cancel the self-timer, select [OFF].

Tips

- You can also operate by pressing PHOTO on the Remote Commander (p. 106).

DIGITAL ZOOM

You can select the maximum zoom level in case you want to zoom to a level greater than 10 × (the default setting) while recording on a tape. Note that the image quality decreases when you are using the digital zoom.

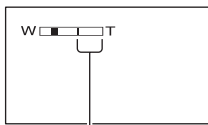

The right side of the bar shows the digital zooming factor. The zooming zone appears when you select the zooming level.

OFF

Up to 10 × zoom is performed optically.

20 ×

Up to 10 × zoom is performed optically, and after that, up to 20 × zoom is performed digitally.

STEADYSHOT

You can compensate for camera shake (The default setting is [ON]). Set [STEADYSHOT] to [OFF] (🚫) when using a tripod (optional), then the image becomes natural.

CONV.LENS

When using an optional conversion lens, use this function to record using the optimum compensation for camera shake for each lens.

▶ OFF

Select this when the conversion lens (optional) is not used.

WIDE CONV. (B_W)

Select this to use the wide conversion lens (optional).

TELE CONV. (B_T)

Select this to use the tele conversion lens (optional).

DIAL SET

You can select a menu item to assign to the CAM CTRL dial. For details, see page 26.

X.V.COLOR HDV1080i

When recording, set to [ON] to capture wider range of colors. Various colors such as the brilliant color of flowers and turquoise blue of the sea can be more faithfully reproduced.

⚙ Notes

- Set [X.V.COLOR] to [ON] only when the recorded content will be played back on an x.v.Color-compliant TV.
- If the movie recorded with this function [ON] is played back on a non-x.v.Color-compliant TV, the color may not be reproduced correctly.
- [X.V.COLOR] cannot be set to [ON] when:
 - Recording in DV format
 - A movie is being recorded.

MEMORY SET menu

Settings for the “Memory Stick Duo”

The default settings are marked with ▶. The indicators in parentheses appear when the items are selected.

See page 39 for details on selecting menu items.

STILL SET

■ QUALITY

▶ FINE (FINE)

Records still images at the fine image quality level.

STANDARD (STD)

Records still images at the standard image quality level.

⚙ Notes

- Image quality is automatically fixed to [FINE] during Easy Handycam operation.

■ IMAGE SIZE

▶ 6.1M (6.1M)

Records still images clearly.

4.6M (4.6M)

Records still images clearly in the 16:9 (wide) ratio.

3.1M (3.1M)

Allows you to record more still images in relatively clear quality.

VGA (0.3M) (LVGA)





Allows for the maximum number of images to be recorded.

⚙ Notes



- [ IMAGE SIZE] can be set only when the POWER switch is set to CAMERA-MEMORY.



Capacity of the “Memory Stick Duo” and the number of recordable pictures

When the POWER switch is set to CAMERA-MEMORY



	6.1M 2848 × 2136 	4.6M 2848 × 1602 	3.1M 2048 × 1536 	VGA 640 × 480 
128MB	41 98	55 130	80 185	780 1970
256MB	75 175	95 235	140 335	1400 3550
512MB	150 365	205 485	295 690	2900 7300
1GB	315 740	420 950	610 1400	6000 14500
2GB	630 1500	850 2000	1200 2850	12000 30000
4GB	1250 2950	1650 3950	2400 5600	23500 59500
8GB	2500 6000	3350 8000	4900 11000	48000 115000





When the POWER switch is set to CAMERA-TAPE*

	4.6M 2848 × 1602 	3.4M 2136 × 1602 
128MB	55 130	74 170
256MB	95 235	130 305
512MB	205 485	275 630
1GB	420 950	560 1300
2GB	850 2000	1100 2600
4GB	1650 3950	2250 5200
8GB	3350 8000	4500 10000

*  IMAGE SIZE] is fixed to  4.6M] in HDV or DV format (16:9) and  3.4M] in DV format (4:3).

When the POWER switch is set to PLAY/EDIT*

	1.2M 1440 × 810 	VGA 640 × 480 	0.2M 640 × 360 
128MB	205 490	780 1970	980 1970
256MB	370 890	1400 3550	1750 3550
512MB	770 1800	2900 7300	3650 7300
1GB	1550 3750	6000 14500	7500 14500
2GB	3150 7500	12000 30000	15000 30000
4GB	6300 14500	23500 59500	29500 59500
8GB	12500 30000	48000 115000	60000 115000

*  IMAGE SIZE] is fixed to  1.2M] in HDV format,  0.2M] in DV format (16:9) and  VGA (0.3M)] in DV format (4:3).

Notes

- All numbers measured at the following settings:
Top: [FINE] is selected for image quality.
Bottom: [STANDARD] is selected for image quality.
- When using a “Memory Stick Duo” made by Sony Corporation. The number of pictures you can record varies depending on the recording environment and the recording media.
- The unique pixel array of Sony’s ClearVid CMOS sensor and image processing system (new Enhanced Imaging Processor) allows for still image resolution equivalent to the sizes described.

ALL ERASE

Deletes all the pictures without image protection on a “Memory Stick Duo” or in the selected folder.

- 1 Select [ALL FILES] or [CURRNT FOLDER].

[ALL FILES]: Deletes all the images on the “Memory Stick Duo.”

[CURRNT FOLDER]: Deletes all the images in the selected folder.

- 2 Touch [YES] twice → [X].

Notes

- The folder will not be deleted even when you delete all the pictures in the folder.
- Do not do any of the following while [Erasing all data...] is displayed:
 - Operate the POWER switch/operation buttons.
 - Eject the “Memory Stick Duo.”

FORMAT

The “Memory Stick Duo” has been formatted at the factory, and does not require formatting at purchase.

To execute formatting, touch [YES] twice → [X].

Formatting is completed, and all the images will be deleted.

Notes

- Do not do any of the following while [Formatting...] is displayed:
 - Operate the POWER switch/operation buttons.
 - Eject the “Memory Stick Duo.”
- Formatting erases everything on the “Memory Stick Duo” including protected image data and newly created folders.

FILE NO.

► SERIES

Assigns file numbers in sequence even if the “Memory Stick Duo” is replaced with another one. The file number is reset when a new folder is created or the recording folder is replaced with another.

RESET

Resets the file number to 0001 each time the “Memory Stick Duo” is changed.

NEW FOLDER

You can create a new folder (102MSDCF to 999MSDCF) on a “Memory Stick Duo.” When 9,999 images are stored in the current folder, a new folder is automatically created for storing subsequent images.

Touch [YES] → [X].

Notes

- You cannot delete the created folders using your camcorder. You will have to format the “Memory Stick Duo” (p. 51), or delete them using your computer.
- The number of recordable pictures on a “Memory Stick Duo” may decrease as the number of folders increases.

REC FOLDER (Recording folder)

Select the folder to be used for recording with [▲]/[▼], then touch [OK].

Notes

- As the default setting, pictures are saved in the 101MSDCF folder.
- Once you record a picture in a folder, the same folder will be set as the default folder for playback.

PB FOLDER (Playback folder)

Select the playback folder with [▲]/[▼], then touch [OK].

PICT.APPLI. menu

Special effects on pictures or additional functions on recording/playback

The default settings are marked with ►. The indicators in parentheses appear when the items are selected.

See page 39 for details on selecting menu items.

FADER

You can record a transition with the following effects adding to the interval between scenes.

- 1 Select the desired effect in [STBY] (to fading in) or [REC] (to fading out) mode, then touch [OK].

- 2 Press START/STOP.

The fader indicator stops flashing and disappears when the fade is complete.

To cancel before starting the operation, touch [OFF] in step 1.

Once you press START/STOP, the setting is canceled.



WHITE FADER



BLACK FADER



MOSAIC FADER



MONOTONE

When fading in, the picture gradually changes from black and white to color. When fading out, it gradually changes from color to black and white.

INT.REC-STL (Interval photo recording)

You can record still images on the "Memory Stick Duo" at a selected interval. This function is useful to observe the movement of clouds or the changes in daylight, etc.

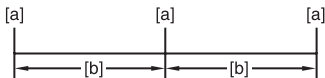

[a]: Recording

[b]: Interval

- 1 Touch [SET] → a desired interval time (1, 5 or 10 minutes) → [OK] → [ON] → [OK] → [X].

- 2 Press PHOTO fully.

stops flashing and the interval still image recording starts.

To cancel [INT.REC-STL], select [OFF].



SLIDE SHOW

Plays back in sequence the images stored on a "Memory Stick Duo," or in a folder (slide show).

- 1 Touch [SET] → [PB FOLDER].
- 2 Select [ALL FILES (a)] or [CURRENT FOLDER (T)], then touch [OK].
If you select [CURRENT FOLDER (T)], all the images in the current playback folder selected in [PB FOLDER] (p. 51) are played back in sequence.
- 3 Touch [REPEAT].
- 4 Select [ON] or [OFF], then [OK].
To repeat the slide show, select [ON] (↺).
To execute the slide show only once, select [OFF].
- 5 Touch [END] → [START].



To cancel [SLIDE SHOW], touch [END].
To pause, touch [PAUSE].

Tips

- You can select the first picture for the slide show with / before touching [START].



D.EFFECT (Digital effect)

You can add digital effects to recording/playback.

- ① Touch the desired effect.
- ② Adjust the effect with /, then touch .

Effect	Items to adjust
CINEMA EFFECT*	No adjustment necessary
STILL	The degree of transparency of the still image you want to superimpose under a movie
FLASH	The interval of frame-by-frame recording/playback
TRAIL	The fade time of the incidental image
OLD MOVIE*	No adjustment necessary

* Available during tape recording only.

- ③ Touch .
 appears.

To cancel [D.EFFECT], touch [OFF].

▶ OFF

Does not use [D.EFFECT] setting.

CINEMA EFFECT (Cinematic effect)

You can add a cinematic atmosphere to pictures by adjusting the image quality.

STILL

Records/plays back a movie while superimposing it on a still image memorized by touching [STILL].



FLASH (flash motion)

Records/plays back a movie with a serial-still-image effect (strobe effect).



TRAIL

When recording/playback, trailing after images are left in the picture.

OLD MOVIE

Adds an old movie effect with a sepia hue to pictures.

Notes

- You cannot change to another digital effect while recording pictures on a tape with [CINEMA EFFECT] selected.
- Effects added to the playback pictures are not output via the  HDV/DV Interface (i.LINK). Only the original pictures can be output.
- While using [D.EFFECT], you cannot use the review button for still images on the “Memory Stick Duo” .
- If you set [CINEMA EFFECT], [SPOT METER] and [EXPOSURE] return to [AUTO].
- You cannot add special effects to pictures from devices connected to your camcorder.

Tips

- You can save pictures edited using special effects on a “Memory Stick Duo” (p. 69) or record them on VCR or DVD/HDD recorders (p. 64).

PICT.EFFECT (Picture effect)

You can add special effects to a picture during recording or playback.  appears.

▶ OFF

Does not use [PICT.EFFECT] setting.

SKINTONE*

Makes skin texture look more smoother and more appealing.

NEG.ART



The color and brightness are reversed.

SEPIA

Pictures appear in sepia.

B&W (Black and white)

Pictures appear in black and white.

SOLARIZE



Pictures appear as an illustration with strong contrast.

PASTEL*



Pictures appear as a pale pastel drawing.

MOSAIC*



Pictures appear mosaic-patterned.

* Available during tape recording only.

🔊 Notes

- Effects added to the playback pictures are not output via the , HDV/DV Interface (i.LINK). Only the original pictures can be output.
- You cannot add special effects to pictures from devices connected to your camcorder.

💡 Tips

- You can save pictures edited using special effects on a “Memory Stick Duo” (p. 69) or record them on VCR or DVD/HDD recorders (p. 64).

SMTH SLW REC (Smooth slow recording)

Fast moving subjects and actions, which cannot be captured under general shooting conditions, can be shot in smooth moving slow-motion for about 3 seconds. This is useful to shoot fast actions such as a golf or tennis swing.

Press START/STOP on the [SMTH SLW REC] screen.

A 3 second-movie (approx.) is recorded as a 12 second slow-motion movie.

[Recording-...] disappears, when recording is finished.

Touch  to set the following.

– [TIMING]

Select the recording start point from the time START/STOP is pressed (The default setting is [3sec AFTER]).

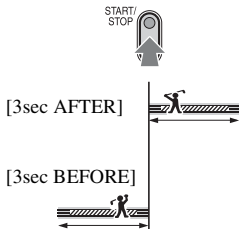

– [RECORD SOUND]

If you set to [ON] () , you can record additional dialog, etc. to the slow-motion movie (The default setting is [OFF]).

Sounds are recorded while [Recording-...] is displayed.

🔊 Notes

- Sounds cannot be recorded while shooting a 3 second-movie (approx.).

- The image quality of [SMTH SLW REC] is somewhat less than normal recording.

To cancel [SMTH SLW REC], select [END].

PictBridge PRINT

See page 71.

USB SELECT

You can connect the camcorder to a personal computer with a USB cable and import pictures to the computer. You can also connect the camcorder to a PictBridge compatible printer using this function. Refer to “First Step Guide” on the supplied CD-ROM for details.

▶ Memory Stick

Select this to view pictures on a “Memory Stick Duo” on the computer or to import them to the computer.

PictBridge PRINT

Select this when you connect the camcorder to a PictBridge compatible printer to print out directly (p. 71).

DEMO MODE

The default setting is [ON], allowing you to view the demonstration about 10 minutes after you have removed both a cassette and a “Memory Stick Duo” from your camcorder, and slide the POWER switch to turn on the CAMERA-TAPE lamp.

Tips

- The demonstration will be suspended in situations such as those described below.
 - When you touch the screen during the demonstration (The demonstration starts again after about 10 minutes).
 - When a cassette or a “Memory Stick Duo” is inserted.
 - When the POWER switch is set to other than CAMERA-TAPE.

EDIT/PLAY menu







Settings for editing or playing back in various modes

See page 39 for details on selecting menu items.

VAR.SPD PB (Various speed playback)

You can play back in various modes while viewing movies.

- ① Touch the following buttons during playback.

To	Touch
change the playback direction*	 (frame)
play back slowly**	 To reverse direction:  (frame) → 
play back frame by frame	 (frame) during playback pause. To reverse direction:  (frame) during frame playback.

* Horizontal lines may appear at the top, bottom, or in the center of the screen. This is not a malfunction.

**Pictures output from the  HDV/DV Interface (i.LINK) cannot be played back smoothly in slow mode.

- ② Touch  → .

To return to the normal playback mode, touch  (Play/Pause) twice (once from frame playback).

Notes

- You will not hear the recorded sound. You may see mosaic-like images of the previously played picture.
- Pictures in the HDV format are not output from the  HDV/DV Interface (i.LINK) when they are paused or played back in any mode other than normal playback mode.
- Pictures in the HDV format may appear distorted during:

- Picture search
- Reverse playback
- Playing back slowly to the reverse direction and playing back frame by frame to the reverse direction are not available in HDV format.

 **REC CTRL**
(Movie recording control)

See page 67.

END SEARCH

EXEC

The most recently recorded picture is played back for about 5 seconds and then stops automatically.

CANCEL

Stops [END SEARCH].

 **Notes**

- [END SEARCH] will not work once you eject the cassette after you have recorded on the tape.

 **STANDARD SET**
menu

Settings while recording on a tape or other basic settings

The default settings are marked with . The indicators in parentheses appear when the items are selected.

See page 39 for details on selecting menu items.

VCR HDV/DV

Select the playback signal. Normally select [AUTO].

When your camcorder is connected to another device using an i.LINK cable, select the signal to input/output from the  HDV/DV Interface (i.LINK). The selected signal is recorded or played back.

 **AUTO**

Switches the signals between HDV and DV format automatically when playing back a tape.

With an i.LINK connection, switches the signals between HDV and DV formats automatically, and inputs/outputs from the  HDV/DV Interface (i.LINK).

HDV

Plays back only the portions recorded in HDV format.

With an i.LINK connection, inputs/outputs only HDV formatted signals from the  HDV/DV Interface (i.LINK), and records/plays back. You can also select this when connecting the camcorder to a computer, etc.

DV

Plays back only the portions recorded in DV format.

With an i.LINK connection, inputs/outputs only DV formatted signals from the  HDV/DV Interface (i.LINK), and records/plays back. You can also select this when connecting the camcorder to a computer, etc.

Notes

- Disconnect the i.LINK cable before changing the [VCR HDV/DV] setting. Otherwise, the connected device, such as a VCR, may not be able to recognize the video signal from your camcorder.
- When [AUTO] is selected, if the signal switches between HDV and DV formats, the picture and sound are interrupted temporarily.
- When [i.LINK CONV] is set to [ON HDV → DV], pictures are output as follows:
 - at [AUTO], an HDV signal is converted to the DV format and output; a DV signal is output as it is.
 - at [HDV], an HDV signal is converted to the DV format and output; a DV signal is not output.
 - at [DV], a DV signal is output as it is; an HDV signal is not output.

REC FORMAT

You can select a recording format.

▶ HDV1080i (HDV1080i)

Records in the HDV1080i specification.

DV (DV)

Records in the DV format.

Notes

- If you output the recording picture using an i.LINK cable, set [i.LINK CONV] accordingly.

DV SET DV

The following functions are available when recording in DV format.

■ [WIDE SELECT] REC MODE (Recording mode)

▶ SP (SP)

Records in the SP (Standard Play) mode on a cassette.

LP (LP)

Increases the recording time to 1.5 times the SP mode (Long Play).

Notes

- If you record in the LP mode, pictures may appear mosaic-like or sound may be interrupted when you play back the tape on other camcorders or VCRs.
- When you mix recordings in the SP mode and in the LP mode on one tape, the playback picture may be distorted or the time code may not be written properly between the scenes.

■ [WIDE SELECT]

You can select the aspect ratio according to the TV connected when recording. Refer also to the instruction manuals supplied with your TV.

▶ 16:9 WIDE

Records pictures in the full screen for a 16:9 (wide) TV screen.

4:3 (4:3)

Records pictures in the full screen for a 4:3 TV screen.

Notes

- Set [TV TYPE] correctly according to the TV connected for playback (p. 59).

■ [WIDE SELECT] AUDIO MODE

▶ 12BIT

Records in the 12-bit mode (2 stereo sounds).

16BIT (16b)

Records in the 16-bit mode (1 stereo sound with high quality).

Notes

- When recording in the HDV format, sound is automatically recorded in [16BIT] mode.

■ [WIDE SELECT] AUDIO MIX

During tape playback, you can monitor the sound recorded by other camcorders using audio dubbing or 4ch microphone recording.

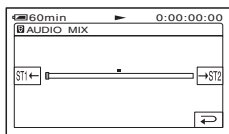

Touch **[ST1+]**/**[+ST2]** to adjust the balance of the original sound (ST1) and the sound recorded afterwards (ST2), then touch **[OK]**.

Notes

- The original sound (ST1) is output at the default setting.

VOLUME

Touch **[−]**/**[+]** to adjust the volume (p. 28).

Tips

- You can also adjust the setting using the CAM CTRL dial (p. 26).

MIC LEVEL

You can adjust the recording sound level manually.

AUTO

Select to adjust the recording sound level automatically.

MANUAL

Touch **[−]**/**[+]** to adjust the recording sound level during recording or standby. The recording sound level adjustment bars appear on the screen. The recording sound level increases as the bar goes to the right. The recording level meter appears when the recording sound level is other than default setting.

Notes

- Use headphones to monitor the sound when adjusting it.

LCD/VF SET

The recorded picture will not be affected by this operation.

LCD BRIGHT

You can adjust the brightness of the LCD screen.

- Adjust the brightness with **[−]**/**[+]**.
- Touch **[OK]**.

LCD BL LEVEL

You can adjust the brightness of the LCD screen's backlight.

NORMAL

Standard brightness.

BRIGHT

Brightens the LCD screen.

Notes

- When you connect your camcorder to outside power sources, [BRIGHT] is automatically selected for the setting.
- When you select [BRIGHT], battery life is slightly reduced during recording.

LCD COLOR

You can adjust the color on the LCD screen with **[−]**/**[+]**.



Low intensity

High intensity

VF B.LIGHT

You can adjust the brightness of the viewfinder.

NORMAL

Standard brightness.

BRIGHT

Brightens the viewfinder screen.

Notes

- When you connect your camcorder to outside power sources, [BRIGHT] is automatically selected for the setting.
- When you select [BRIGHT], battery life is slightly reduced during recording.

COMPONENT

Select [COMPONENT] when connecting your camcorder to a TV with the component input jack.

480i

Select when connecting your camcorder to a TV with the component input jack.

▶ 1080i/480i

Select when connecting your camcorder to a TV that has the component input jack and is capable of displaying the 1080i signal.

i.LINK CONV

Signals in HDV format are converted to DV format, and pictures are output in DV format from the  HDV/DV Interface (i.LINK).

▶ OFF

Outputs the pictures from the  HDV/DV Interface (i.LINK) in accordance with the settings in [REC FORMAT] and [VCR HDV/DV].

ON HDV → DV

Pictures in HDV format are converted to DV format, and pictures in DV format are output in DV format.

Notes

- For input signal via an i.LINK connection, see [VCR HDV/DV] (p. 56).
- Disconnect the i.LINK cable before setting [i.LINK CONV]. Otherwise, the connected video device may not be able to recognize the video signal from your camcorder.

TV TYPE

You need to convert the signal depending on the TV connected when playing back the picture. The recorded pictures are played back as following illustrations.

▶ 16:9

Select to view your pictures on a 16:9 (wide) TV.

16:9 (wide)
pictures



4:3 pictures



4:3

Select to view your pictures on a 4:3 standard TV.

16:9 (wide)
pictures



4:3 pictures



Notes

- When you connect your camcorder to a TV compatible with the ID-1 system, and play back the tape, set [TV TYPE] to [16:9]. The TV automatically switches the aspect ratio according to the playback picture. Refer also to the manual supplied with your TV.
- When you connect your camcorder to a TV with an i.LINK cable to play back the tape, the setting of [TV TYPE] is invalid.

DISP GUIDE (Display guide)

See page 110.

STATUS CHECK

You can check the setup value of the following items.

- [VCR HDV/DV] (when the POWER switch is set to PLAY/EDIT) (p. 56)
- [COMPONENT] (p. 59)
- [i.LINK CONV] (p. 59)
- [TV TYPE] (p. 59)
- HDMI OUTPUT (p. 103)

GUIDEFAME

You can display the frame and check that the subject is horizontal or vertical by setting [GUIDEFAME] to [ON]. The frame is not recorded. Press DISPLAY/BATT INFO to make the frame disappear.

Tips

- Placing the subject at the cross point of the guide frame makes a balanced composition.

CENTER MARKR

When you set [CENTER MARKR] to [ON], the marker is displayed at the center of the screen so you can identify the center of the screen easily. The marker is not recorded. Press DISPLAY/BATT INFO to make the marker disappear.

COLOR BAR

You can display the color bar or record it on the tape by setting [COLOR BAR] to [ON]. It is convenient to adjust the color on the monitor connected.

DATA CODE

During playback, displays the information (data code) recorded automatically at the time of recording.

▶ OFF

Data code is not displayed.

DATE/TIME

Displays the date and time.

CAMERA DATA (below)

Displays camera setting data.

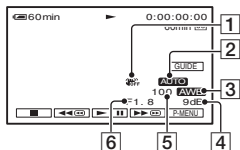

1 SteadyShot off

2 Exposure

3 White balance

4 Gain

5 Shutter speed

6 Aperture value

Notes

- The exposure adjustment value (0EV), a shutter speed, and the aperture value appear when still images on a “Memory Stick Duo” are played back.
- ⚡ appears for a picture recorded using a flash.
- In the DATE/TIME data display, the date and time are displayed in the same area. If you record a picture without setting the clock, [--- --:--] and [--:--:--] will appear.
- During Easy Handycam operation, you can set only [DATE/TIME].

REMAINING

▶ AUTO

Displays the remaining tape indicator for about 8 seconds in situations such as those described below.

- When you set the POWER switch to PLAY/EDIT or CAMERA-TAPE with a cassette inserted.
- When you touch (Play/Pause).

ON

Always displays the remaining tape indicator.

REMOTE CTRL (Remote control)

The default setting is [ON], allowing you to use the supplied Remote Commander (p. 106).

Tips

- Set to [OFF] to prevent your camcorder from responding to a command sent by remote control units of other camcorders or VCRs.

REC LAMP (Recording lamp)

The camera recording lamp will not light up during recording when you set this to [OFF] (The default setting is [ON]).

BEEP

► ON

A beeping sound starts when you start/stop recording, or operate the touch panel.

OFF

Cancels the beeping sound and shutter sound.

DISP OUTPUT (Display output)

► LCD PANEL

Shows displays such as the time code on the LCD screen and in the viewfinder.

V-OUT/PANEL

Shows displays such as the time code on the TV screen, LCD screen, and in the viewfinder.

MENU ROTATE

► NORMAL

Scrolls the menu items downwards by touching .

OPPOSITE

Scrolls the menu items upwards by touching .

A.SHUT OFF (Auto shut off)

► 5min

The camcorder is automatically turned off when you do not operate your camcorder for more than approximately 5 minutes.

NEVER

The camcorder is not automatically turned off.

⚙ Notes

- When you connect your camcorder to a wall outlet (wall socket), [A.SHUT OFF] is automatically set to [NEVER].

CALIBRATION

See page 98.

QUICK REC (Quick recording)

HDV1080i

You can slightly reduce the recording start point time when you start recording by pressing START/STOP. This function is useful to compensate for time lapse at the click of the shutter.

► OFF

Takes more time to reach the recording start point, but a smooth transition can be recorded.

ON (Q.REC)

Slightly reduces the time it takes to start recording when you attempt to record right after you switch on the camcorder (set the POWER switch to CAMERA-TAPE from the OFF (CHG) position), or when you attempt to record when the recording standby mode is canceled.

⚙ Notes

- If [QUICK REC] is set to [ON], the interval between scenes freezes for a moment (editing on your computer is recommended).

💡 Tips

- If the recording standby mode continues more than approximately 3 minutes, the drum will stop rolling, and the standby mode is canceled. This is to protect the tape and to prevent from unnecessarily battery exhausting.



TIME/LANGU. menu

See page 39 for details on selecting menu items.

CLOCK SET

See page 16.

WORLD TIME

When using your camcorder abroad, you can set the time difference by touching  / , the clock will be adjusted in accordance with the time difference.

If you set the time difference to 0, the clock returns to the originally set time.

LANGUAGE

You can select the language to be used on the LCD screen.

- Your camcorder offers [ENG[SIMP]] (simplified English) for when you cannot find your native tongue among the options.

Customizing Personal Menu

You can add desired menu items to any Personal Menu, and customize Personal Menu settings for each POWER lamp position. This is convenient if you add frequently used menu items to Personal Menu.

Adding a menu item

You can add up to 28 menu items for each POWER lamp position. Delete a less important menu item, if you want to add more.

- 1 Touch  → [P-MENU SET UP] → [ADD].

If the desired menu item is not displayed, touch .

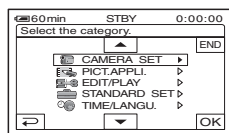

- 2 Touch  to select a menu category, then touch .

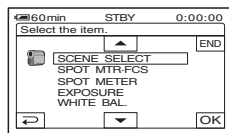

- 3 Touch  to select a menu item, then touch  → [YES] → .

The menu item is added to the end of the list.

Deleting a menu item

- 1 Touch [P-MENU] → [P-MENU SET UP] → [DELETE].

If the desired menu item is not displayed, touch \uparrow/\downarrow .

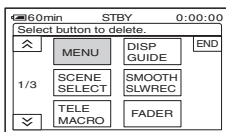

- 2 Touch the menu item that you want to delete.

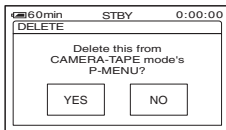

- 3 Touch [YES] → \times .

Notes

- You cannot delete [MENU] and [P-MENU SET UP].

Arranging the order of menu items displayed on Personal Menu

- 1 Touch [P-MENU] → [P-MENU SET UP] → [SORT].

If the desired menu item is not displayed, touch \uparrow/\downarrow .

- 2 Touch the menu item you want to move.

- 3 Touch \uparrow/\downarrow to move the menu item to the desired place.

- 4 Touch [OK].

To sort more items, repeat steps 2 to 4.

- 5 Touch [END] → \times .

Notes

- You cannot move [P-MENU SET UP].

Initializing the Personal Menu settings (Reset)

- Touch [P-MENU] → [P-MENU SET UP] → [RESET] → [YES] → [YES] → \times .

If the desired menu item is not displayed, touch \uparrow/\downarrow .

Dubbing to VCR or DVD/HDD recorders

Connect your camcorder to the wall outlet (wall socket) using the supplied AC Adaptor for this operation (p. 13). Refer also to the instruction manuals supplied with the devices to be connected.

















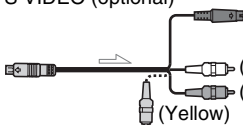

Connecting to external devices

The connection method and the image quality will differ depending on the VCR or DVD/HDD recorders and the connectors used.

⚡ Tips

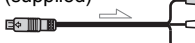
- [CONNECTGUIDE] recommends the appropriate connection method for your device (p. 31).

↗ : Signal flow

Camcorder	Cable	External device
	i.LINK cable (supplied) 	i.LINK  HDV1080i compatible device* → HD quality 
	i.LINK cable (supplied) 	i.LINK  AV device with i.LINK jack → SD quality 
	A/V connecting cable with S VIDEO (optional)  (White) (Red) (Yellow)	S VIDEO  VIDEO  AUDIO  AV device with S VIDEO jack → SD quality 
	A/V connecting cable (supplied)  (Yellow) (White) (Red)	VIDEO  AUDIO  AV device with audio/video jacks** → SD quality 

* An i.LINK jack which is compatible with HDV1080i specification is required. For details, refer to the instruction manuals supplied with the device to be connected.

** When connecting your camcorder to a monaural device, connect the yellow plug of the A/V connecting cable to the video jack on the device, and the white (left channel) or red (right channel) plug to the audio jack on the device.

Notes

- You cannot dub pictures using the HDMI cable.
- Pictures recorded in the DV format are dubbed as SD (standard definition) images, regardless of the connection.

Jacks on your camcorder

Open the jack cover and connect the cable.

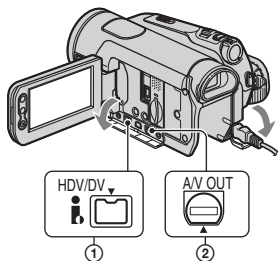

Using an i.LINK cable (supplied)

Select the required settings from the table below and make the menu settings.

Notes

- Disconnect the i.LINK cable before changing these menu settings, otherwise the VCR or DVD/HDD recorders may not correctly identify the video signal.

Recorded format	Dubbing format	Menu setting	
		[VCR HDV/DV]	[i.LINK CONV]
HDV only	HDV* ¹	[AUTO] or HDV	[OFF]
	DV	[AUTO]	[ON HDV → DV]
Mixed HDV and DV	HDV* ¹	[AUTO] or HDV* ²	[OFF]
	DV	[AUTO]* ³	[ON HDV → DV]
DV only	DV	[AUTO] or DV	–

*¹ The VCR or DVD/HDD recorders need to be compliant with HDV1080i specification.

*² Parts recorded in DV format cannot be dubbed.

*³ Parts recorded in both DV and HDV format can be dubbed.

Notes

- When [VCR HDV/DV] is set to [AUTO], and the signal switches between HDV and DV formats, the picture and sound are interrupted temporarily.
- When the player and the recorder are both HDV1080i compatible devices such as HDR-HC9 and are connected with the i.LINK cable, after pausing or stopping and then resuming the recording, the images will be unstable or rough at that point.
- Set [DISP OUTPUT] to [LCD PANEL] (default setting) when connecting with an A/V connecting cable (p. 61).

When connecting with the A/V connecting cable with an S VIDEO (optional)

Connect with S VIDEO jack instead of the video plug (yellow). This connection produces pictures more faithfully. The audio will not be output when you connect with the S VIDEO cable alone.

Dubbing to another device

1 Prepare your camcorder for playback.

Insert the recorded cassette.
Slide the POWER switch to turn on the PLAY/EDIT lamp.

2 When dubbing to the VCR, insert a cassette for recording. When dubbing to the DVD recorder, insert a DVD for recording.

If your recording device has an input selector, set it to the appropriate input (such as video input1 and video input2).

3 Connect your recording device (VCR or DVD/HDD recorder) to your camcorder.



See page 64 for connection details.

4 Start playback on your camcorder, and recording on the recording device.

Refer to the operating instructions supplied with your recording device for details.



5 When dubbing is complete, stop your camcorder and the recording device.

Notes

- When connecting with an A/V connecting cable, set [TV TYPE] according to the playback device (TV, etc.) (p. 59).
- To record the date/time and camera settings data when connected by the A/V connecting cable, display them on the screen (p. 60).
- The following cannot be output via the  HDV/DV interface (i.LINK):
 - Indicators
 - Pictures edited with [PICT.EFFECT] (p. 54) or [D.EFFECT] (p. 53)
 - Titles that are recorded on other camcorders
- Pictures recorded in the HDV format are not output from the  HDV/DV Interface (i.LINK) during playback pause or in any playback mode other than normal playback.
- Note the following when connecting with an i.LINK cable:
 - The recorded picture becomes rough when a picture is paused on your camcorder while recording to a VCR or DVD/HDD recorder.
 - Data codes (date/time/camera settings data) may not be displayed or recorded depending on the device or application.
 - You cannot record the picture and sound separately.

- When dubbing to a DVD recorder from your camcorder through an i.LINK cable, you may not operate your camcorder on your DVD recorder even if its instruction manual says you can.

If you can set the input mode to HDV or DV on your DVD recorder and can input/output pictures, follow the steps in “Dubbing to another device.”

- When you use an i.LINK cable, the video and sound signals are transmitted digitally, producing high quality pictures.
- When an i.LINK cable is connected, the format of the output signal (**HDVout**  or **DVout** ) will be indicated on the LCD screen of your camcorder.

Recording pictures from a VCR, etc.

You can record movies from a VCR on a tape. You can record a scene as a still image on a "Memory Stick Duo." Be sure to insert a cassette or a "Memory Stick Duo" for recording in your camcorder beforehand. You can connect your camcorder to a VCR, etc., or an i.LINK-compatible device using the i.LINK cable.

Connect your camcorder to the wall outlet (wall socket) using the supplied AC Adaptor for this operation (p. 13). Refer also to the instruction manuals supplied with the devices to be connected.

HDV1080i compatible device AV device with i.LINK output jack

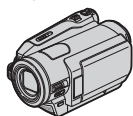

→ HD quality



→ SD quality

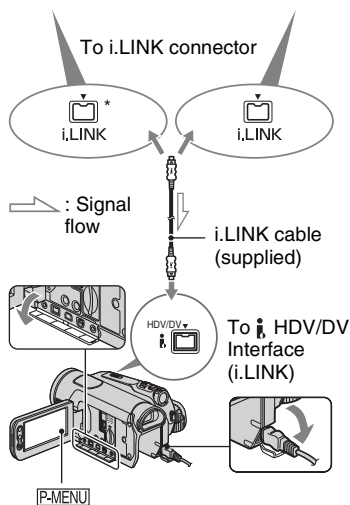

* An i.LINK jack which is compatible with HDV1080i specification is required.

Recording movies

1 Slide the **POWER** switch to turn on the **PLAY/EDIT** lamp.



2 Set the input signal of your camcorder.

Set [VCR HDV/DV] to [AUTO] when recording from an HDV format compatible device.

Set [VCR HDV/DV] to [DV] or [AUTO] when recording from a DV format compatible device (p. 56).

3 Connect your VCR, etc as a player to your camcorder with an i.LINK cable.



Notes

- When an i.LINK cable is connected, the format of the input signal (**HDVIN ** or **DVIN **) will be indicated on the LCD screen of your camcorder (This indicator may appear on the screen of the playback device, however, it will not be recorded).

4 Insert a cassette into the VCR.

5 Operate your camcorder to record movies.

Touch [P-MENU] → [ REC CTRL] → [REC PAUSE].

If the desired item is not displayed on the screen, touch [/] until the item is displayed.

6 Start playing the cassette on your VCR.

The picture played on the connected device appears on the LCD screen of your camcorder.

7 Touch [REC START] at the point you want to start recording.

8 Stop recording.

Touch  (Stop) or [REC PAUSE].

9 Touch → .

Notes

- You cannot record TV programs from the  HDV/DV Interface (i.LINK).
- You can record pictures from DV devices only in the DV format.
- Note the following when connecting with an i.LINK cable:
 - The recorded picture becomes rough when a picture is paused on a VCR while recording to your camcorder.
 - You cannot record the picture and sound separately.
 - If you pause or stop the recording and restart it, the picture may not be recorded smoothly.
- When a 4:3 video signal is input, it appears with black bands on the right and left sides on the screen of your camcorder.

Recording still images

1 Perform steps 1 to 4 in “Recording movies.”

2 Start playing the cassette.

The pictures on the VCR appear on the screen of your camcorder.

3 Press PHOTO lightly at the scene you want to record. Check the image and press it fully.

Dubbing pictures from a tape to a “Memory Stick Duo”



You can record a desired scene onto a “Memory Stick Duo” as a still image, from a movie you recorded on a tape. Make sure you have a recorded tape and a “Memory Stick Duo” inserted into your camcorder.

1 Slide the **POWER** switch repeatedly to turn on the **PLAY/EDIT** lamp.

2 Search and record the scene you want to record.

Touch  (Play) to play back the tape, then press **PHOTO** lightly at the scene you want to record. Check the image and press it fully.

Notes

- The date and time the picture is recorded on the tape and stored on the “Memory Stick Duo” are recorded. On your camcorder, the date and time the picture is recorded on the tape are displayed. Camera setting data recorded on the tape cannot be stored on the “Memory Stick Duo.”
- Still images will be fixed to image size  1.2M] when playing back in the HDV format. Still images will be fixed to image size  0.2M] (16:9) or [VGA (0.3M)] (4:3) when playing back in the DV format (p. 50).
- You cannot record still images while using PB zoom.

Deleting recorded pictures from the “Memory Stick Duo”

1 Slide the **POWER** switch repeatedly to turn on the **PLAY/EDIT** lamp.

2 Touch .

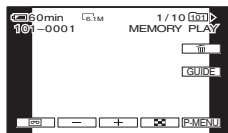



3 Select a picture you want to delete with  / .

4 Touch  → [YES].

Notes

- The pictures cannot be restored once they are deleted.
- Pictures cannot be deleted when a “Memory Stick Duo” with the write-protect tab is set to the write-protect position (p. 91), or when the selected picture is protected (p. 70).

Tips

- To delete all pictures at once, select  ALL ERASE] (p. 51).
- You can delete pictures on the index screen (p. 29). You can easily search for the picture to be deleted by displaying 6 pictures at once. Touch [SET] →  DELETE] → the picture you want to delete →  → [YES].

Marking images on the “Memory Stick Duo” with specific information (Print mark/Image protection)

When you are using a “Memory Stick Duo” with the write-protect tab, make sure the write-protect tab on the “Memory Stick Duo” is not set to the write-protect position (p. 92).

Selecting still images for printing (Print mark)

The DPOF (Digital Print Order Format) standard is used to select images for printing on your camcorder.

By marking images that you want to print out, you do not need to reselect them when you print them out (You cannot specify the number of printouts).

1 Slide the POWER switch repeatedly to turn on the PLAY/EDIT lamp.

2 Touch [MEMORY] →  → [SET] → [PRINT MARK].

3 Touch the image that you want to print out later.

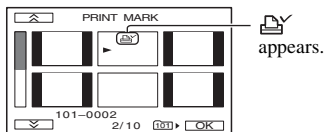

4 Touch [OK] → [END].

Notes

- To cancel Print mark, touch the image again to cancel Print mark in step 3.
- Do not mark images on your camcorder if the “Memory Stick Duo” already has some images with the Print mark put on using other devices.

This may change the information of the images with the Print mark put on using the other device.

Preventing accidental erasure (Image protection)

You can select and mark images to prevent accidental erasure.

1 Slide the POWER switch repeatedly to turn on the PLAY/EDIT lamp.

2 Touch [MEMORY] →  → [SET] → [PROTECT].

3 Touch the image that you want to protect.

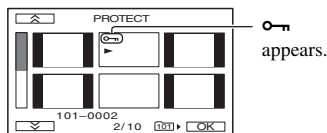

4 Touch [OK] → [END].

Notes

- To cancel image protection, touch the image again to cancel image protection in step 3.

Printing recorded images (PictBridge compliant printer)

You can print out pictures using a PictBridge compliant printer without connecting the camcorder to a computer.

PictBridge

Connect your camcorder to the AC Adaptor to obtain power from the wall outlet (wall socket) (p. 13).

Insert the “Memory Stick Duo” containing still images into your camcorder and turn on the printer.

1 Slide the **POWER** switch repeatedly to turn on the **PLAY/EDIT** lamp.

2 Connect the  (**USB**) jack of your camcorder to the printer using the **USB** cable.

[**USB SELECT**] appears on the screen automatically.

3 Touch [**PictBridge PRINT**].

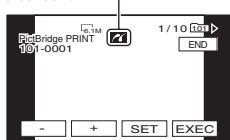

When connection is complete,  (**PictBridge connecting**) appears on the screen.



One of the images stored on the “Memory Stick Duo” will be displayed.

4 Select the image to be printed with  / .

5 Touch [**SET**] → [**COPIES**].

6 Select the number of copies to be printed with  / .

A maximum of 20 copies of the image can be printed.

7 Touch [**OK**] → [**END**].

To print the date/time on the image, touch [**SET**] → [**DATE/TIME**] → [**DATE**] or [**DAY&TIME**] → [**OK**].

8 Touch [**EXEC**] → [**YES**].

When printing is finished, [**Printing...**] disappears and the image selection screen appears again.

To finish printing

Touch [**END**] on the image selection screen.



Notes

- We cannot guarantee the operation of models that are not PictBridge compatible.
- Refer also to the operating instructions for the printer to be used.
- Do not attempt the following operations when  is on the screen. The operations may not be performed properly.
 - Operate the **POWER** switch.
 - Disconnect the **USB** cable from the printer or your camcorder.
 - Remove the “Memory Stick Duo” from your camcorder.
- If the printer stops working, disconnect the **USB** cable, turn the printer off and on again and restart the operation from the beginning.
- Some printers may cut off left, right, top and lower parts of the image. Especially, when the image is recorded with a 16:9 (wide) ratio, left and right parts may be largely cut off.
- Some printer models may not support the date/time printing function. Refer to your printer’s operating instructions for details.

Printing recorded images (Continued)

- We cannot guarantee the printing of images recorded with a device other than your camcorder.

Tips

- PictBridge is an industry standard established by the Camera & Imaging Products Association (CIPA). You can print still images without using a computer by connecting a printer directly to a digital video camera or digital still camera, regardless of model or manufacturer.
- You can also operate by selecting in the following orders:
 - [P-MENU] → [MENU] →  (PICT.APPL.) → [USB SELECT] → [PictBridge PRINT].
 - [P-MENU] → [MENU] →  (PICT.APPL.) → [PictBridge PRINT].

What you can do with Windows computer

When you install the “Picture Motion Browser” on a Windows computer from the supplied CD-ROM, you can enjoy the following operations.

🔊 Notes

- You cannot install the supplied software, “Picture Motion Browser,” on a Macintosh computer.

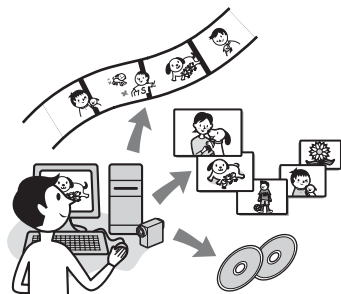

Main functions

■ Importing movies taken with your camcorder

You can import the movies recorded with HD (high definition) image quality as they are.

■ Viewing images imported to a computer

You can manage movies and still images by date and time of shooting, and select movies or still images you want to view as thumbnails. These thumbnails can be enlarged and played in a slide show.

■ Editing pictures imported to a computer

You can edit imported movies and still images on a computer.

■ Creating a disc

You can create a DVD-video with imported movies. The image quality of the disc will be SD (standard definition).

■ Exporting imported movies from a computer to your camcorder

You can send movies which were imported to the computer back to your camcorder in HD (high definition) image quality.

About “First Step Guide”

The “First Step Guide” is an instruction manual you can refer to on your computer. This describes basic operations, from initial hookup of your camcorder and computer and making settings, to general operation the first time you use the software “Picture Motion Browser” stored on the CD-ROM (supplied).

Referring to “Installing the “First Step Guide”” (p. 75), start the “First Step Guide,” then follow the instructions.

About the help function of the software

The Help guide explains all the functions of the software applications. Refer to the Help guide for further detailed operations after reading the “First Step Guide” thoroughly. To display the Help guide, click the [?] mark on the screen.

🔊 Notes

- You also need to make certain settings on your camcorder when importing movies to a computer with commercially available editing software. For details, refer to “First Step Guide.”
- Refer to the following website for the “Picture Motion Browser” customer support.
<http://www.sony.net/support-disoft/>

System requirements

When using “Picture Motion Browser”

OS: Microsoft Windows 2000 Professional SP4, Windows XP SP2* or Windows Vista*
*64-bit editions and Starter (Edition) are not supported.
Standard installation is required.
For processing HD footage, Windows XP SP2 or Windows Vista is required.
Operation is not assured if the above OS has been upgraded or in a multi-boot environment.

CPU: Intel Pentium 4 2.8 GHz CPU or faster (Intel Pentium 4 3.2 GHz or faster, Intel Pentium D, or Intel Core Duo is recommended.)
For processing SD (standard definition) image quality content only, an Intel Pentium III 1 GHz or faster is necessary.

Application: DirectX 9.0c or later (This product is based on DirectX technology. It is necessary to have DirectX installed.)

Sound system: Direct Sound compatible sound card

Memory: 512 MB or more (1 GB or more is recommended.)
For processing SD (standard definition) image quality content only, 256 MB of memory or more is necessary.

Hard disk:
Disc volume required for installation: Approximately 500 MB

Display: Minimum 1,024 × 768 dots

Others: ψ USB port (this must be provided as standard, Hi-Speed USB (USB 2.0 compatible) is recommended), DV Interface (IEEE1394, i.LINK) (to connect via an i.LINK cable), DVD burner (CD-

ROM drive is necessary for installation)

When playing still images recorded on a “Memory Stick Duo” on a computer

OS: Microsoft Windows 2000 Professional SP4, Windows XP SP2* or Windows Vista*
*Except for 64-bit editions.
Standard installation is required.
Operation is not assured if the above OS has been upgraded.

Others: ψ USB port (this must be provided as standard)

⚙ Notes

- Operations are not guaranteed on a computer environment that does not meet the system requirements.
- Operations are not guaranteed on all the recommended environments.
For example, other open or background applications running on currently may limit product performance.
- Even in a computer environment where the operations are guaranteed, frames may be dropped from movies with HD (high definition) image quality, resulting in uneven playback. However, imported images and images on discs created subsequently will not be affected.
- If you use a Notebook PC, connect it to the AC Adaptor as the power source. Otherwise, the software will not work properly due to the power saving function of the PC.

💡 Tips

- If your computer has a Memory Stick slot, insert the “Memory Stick Duo” on which still images are recorded into the Memory Stick Duo Adaptor (optional), then insert it into the Memory Stick slot on your computer to copy still images to the computer.
- When using a “Memory Stick PRO Duo” and your computer is not compatible with it, connect your camcorder with the USB cable instead of using the Memory Stick slot on the computer.

Installing the “First Step Guide” and software

You need to install the “First Step Guide” and software to your Windows computer **before connecting your camcorder to the computer**. The installation is required only for the first time. Contents to be installed and procedures may differ depending on your OS.

💡 Tips

- See page 77 when you use a Macintosh computer.

Installing the “First Step Guide”

1 Confirm that your camcorder is not connected to the computer.

2 Turn on the computer.

🔑 Notes

- Log on as an Administrator for installation.
- Close all applications running on the computer before installing the software.

3 Place the supplied CD-ROM in the disc drive of your computer.

The installation screen appears.



If the screen does not appear

- ① Click [Start], then click [My Computer]. (For Windows 2000, double-click [My Computer].)
- ② Double-click [SONYPICUTIL (E:)] (CD-ROM) (disc drive).*

* Drive names (such as (E:)) may vary depending on the computer.

4 Click [FirstStepGuide].

5 Select the desired language and the model name of your camcorder from the pull-down menu.



6 Click [FirstStepGuide(HTML)].

Installation starts.

When [Save is complete] appears, click [OK] to finish the installation.

To view the “First Step Guide” in PDF

In step 6, click [FirstStepGuide(PDF)].

To install the software “Adobe Reader” to display the PDF file

In step 6, click [Adobe(R) Reader(R)].

Installing the software

1 Perform steps 1 to 3 in “Installing the “First Step Guide”” (p. 75).

2 Click [Install].

3 Select the language for the application to be installed, then click [Next].

4 Check your area and country/region, then click [Next].

The software to be installed will be configured according to your country/region.

5 Read [License Agreement], select [I accept the terms of the license agreement] when you agree, then click [Next].

6 Slide the POWER switch repeatedly to turn on the PLAY/EDIT lamp after the connection confirmation display appears.

7 Connect your camcorder and computer with an i.LINK cable or USB cable.

When connecting with a USB cable, [USB SELECT] appears on the screen of your camcorder. Select [Memory Stick]. Click [Next] after connection is complete.



A message stating that you need to restart may appear, but you do not need to restart at this time. Restart the computer after the installation is complete.

8 Follow the on-screen instructions to install the software.

Depending on the computer, you may need to install third party software (shown below). If the installation screen appears, follow the instructions to install the required software.

- Microsoft DirectX 9.0c-Software required to handle movies
- Windows Media Format 9 Series Runtime (Windows 2000 only)-Software required to create a DVD

Restart the computer if required to complete the installation.

9 Remove the CD-ROM from the disc drive of your computer.

The short-cut icons, such as [Picture Motion Browser] (“Picture Motion Browser”), appear on the desktop.



💡 Tips

- For the information about disconnecting the cable, refer to “First Step Guide.”

Viewing “First Step Guide”

To view “First Step Guide” on your computer, Microsoft Internet Explorer Ver.6.0 or later is recommended. Double-click the short-cut icon for your camcorder’s “First Step Guide” on the desktop.

Tips

- You can also start by selecting [Start] → [Programs] ([All Programs] for Windows XP) → [Sony Picture Utility] → [FirstStepGuide] → Your camcorder’s folder → “First Step Guide” in HTML.
- To view “First Step Guide” in HTML without installing, copy the desired language folder from the [FirstStepGuide] folder on the CD-ROM, and then double-click [Index.html].
- Refer to your camcorder’s “First Step Guide” in PDF (p. 75) in the following cases:
 - When printing the desired topics of “First Step Guide”
 - When “First Step Guide” is not displayed correctly due to the browser setting even in recommended environment.
 - When the HTML version of “First Step Guide” cannot be installed.

Using a Macintosh computer

You can copy the still images from the “Memory Stick Duo” to the Macintosh. Install “First Step Guide” in the supplied CD-ROM.

Notes

- The supplied software “Picture Motion Browser” does not operate on Mac OS.
- You also need to make certain settings on your camcorder when importing movies to a computer with commercially available editing software. For details, refer to “First Step Guide.”

System requirements

To copy still images from a “Memory Stick Duo”

OS: Mac OS 9.1/9.2 or Mac OS X (v10.1/v10.2/v10.3/v10.4).

Others:  USB port (this must be provided as standard)

About “First Step Guide”

The “First Step Guide” is an instruction manual you can refer to on your computer. This describes basic operations, from initial hookup of your camcorder and computer and making settings, to general operation the first time you use the software. Referring to “Installing the “First Step Guide””, start the “First Step Guide,” then follow the instructions.

To install “First Step Guide”

Copy “FirstStepGuide(PDF),” stored in the desired language folder in the [FirstStepGuide] folder, to your computer.

To view “First Step Guide”

Double-click “FirstStepGuide(PDF).” If software to view PDF files is not installed on your computer, download Adobe Reader from their website, below;
<http://www.adobe.com/>

Troubleshooting

If you run into any problems using your camcorder, use the following table to troubleshoot the problem. If the problem persists, disconnect the power source and contact your Sony dealer.

- Overall operations/Easy Handycam/
Remote Commander.....78
- Batteries/Power sources79
- LCD screen/viewfinder79
- Cassette tapes/“Memory Stick Duo”80
- Recording81
- Playback83
- Playing back on TV84
- Dubbing/Editing/Connecting to other
devices84
- Connecting to a computer85
- Functions that cannot be used together
.....85

Overall operations/Easy Handycam/Remote Commander

The power does not turn on.

- Attach a charged battery pack to the camcorder (p. 13).
- Use the AC Adaptor to connect to a wall outlet (wall socket) (p. 13).

The camcorder does not operate even when the power is set to on.

- Disconnect the AC Adaptor from the wall outlet (wall socket) or remove the battery pack, then reconnect it after about 1 minute.
- Press the RESET button (p. 104) using a sharp-pointed object (If you press the RESET button, all settings are reset, except Personal Menu items).

Buttons do not work.

- During Easy Handycam operation, not all buttons are functional (p. 22).

Settings change during Easy Handycam operation.

- During Easy Handycam operation, the settings of the functions that are not displayed on the screen return to their defaults (p. 22, 40).

The menu item settings have changed unexpectedly.

- The following settings return to the default settings automatically when you set the POWER switch to OFF (CHG) for more than 12 hours.
 - backlight
 - [SCENE SELECT]
 - [SPOT MTR-FCS]
 - [SPOT METER]
 - [EXPOSURE]
 - [WHITE BAL.]
 - [SHUTTR SPEED]
 - [SPOT FOCUS]
 - [FOCUS]
 - [ AUDIO MIX] of [DV SET] DV
 - [MIC LEVEL]

The camcorder gets warm.

- The camcorder may get warmer while you use it. This is not a malfunction.

The supplied Remote Commander does not function.

- Set [REMOTE CTRL] to [ON] (p. 60).
- Remove any obstructions between the Remote Commander and the remote sensor.
- Keep strong light sources, such as sunlight or overhead lighting, away from the remote sensor, otherwise the Remote Commander may not function properly.
- Insert a fresh battery in the compartment with its +/- terminals matching those of the compartment (p. 106).

Another VCR malfunctions when you use the supplied Remote Commander.

- Select a commander mode other than VTR 2 for your VCR.
- Cover the sensor of your VCR with black paper.

Batteries/Power sources

The power abruptly turns off.

- When approximately 5 minutes have elapsed while you do not operate your camcorder, the camcorder is automatically turned off (A.SHUT OFF). Change the setting of [A.SHUT OFF] (p. 61), or turn on the power again (p. 16), or use the AC Adaptor.
- Charge the battery pack (p. 13).

The ζ /CHG (charge) lamp does not light while the battery pack is being charged.

- Slide the POWER switch to OFF (CHG) (p. 13).
- Attach the battery pack to the camcorder correctly (p. 13).
- Connect the power cord (mains lead) to the wall outlet (wall socket) properly.
- The battery charge is completed (p. 13).

The ζ /CHG (charge) lamp flashes while the battery pack is being charged.

- Attach the battery pack to the camcorder correctly (p. 13). If the problem persists, disconnect the AC Adaptor from the wall outlet (wall socket) and contact your Sony dealer. The battery pack may be damaged.

The remaining battery time indicator does not indicate the correct time.

- Ambient temperature is too high or too low, or the battery pack has not been charged enough. This is not a malfunction.

- Fully charge the battery again. If the problem persists, the battery may be worn-out. Replace it with a new one (p. 13, 93).
- The indicated time may not be correct in certain circumstances. For example, when you open or close the LCD panel, it takes about 1 minute to display the correct remaining battery time.

The battery pack discharges too quickly.



- Ambient temperature is too high or low, or the battery pack has not been charged enough. This is not a malfunction.
- Fully charge the battery again. If the problem persists, the battery may be worn-out. Replace it with a new one (p. 13, 93).

LCD screen/viewfinder

You cannot turn the LCD backlight off.

- During Easy Handycam operation, you cannot turn the LCD backlight on/off by pressing and holding DISPLAY/BATT INFO (p. 22).

You cannot turn off the indicator.

- You cannot turn off . Touch  to check the warning messages (p. 88).

The buttons do not appear on the touch panel.

- Touch the LCD screen lightly.
- Press DISPLAY/BATT INFO on your camcorder (or DISPLAY on the Remote Commander) (p. 18, 106).

The buttons on the touch panel do not work correctly or do not work at all.

- Adjust the touch panel ([CALIBRATION]) (p. 98).

Troubleshooting (Continued)

Menu items are grayed out.

- You cannot select grayed items in the current recording/playback situation.
- Depending on the functions, you may not be able to use them together (p. 85).

[P-MENU] is not displayed.

- During Easy Handycam operation, not all menu items are functional. Cancel Easy Handycam operation (p. 22).

The picture in the viewfinder is not clear.

- Move the viewfinder lens adjustment lever until the picture appears clearly (p. 18).

The picture in the viewfinder has disappeared.

- Close the LCD panel. The picture is not displayed in the viewfinder when the LCD panel is open (p. 18).

Cassette tapes/"Memory Stick Duo"

The cassette cannot be ejected from the compartment.

- Make sure the power source (battery pack or AC Adaptor) is connected correctly (p. 13).
- Moisture condensation has occurred inside the camcorder (p. 96).

The Cassette Memory indicator or title display does not appear while using a cassette with Cassette Memory.

- This camcorder does not support Cassette Memory, so the indicator does not appear.

The remaining tape indicator is not displayed.

- Set [REMAINING] to [ON] to always display the remaining tape indicator (p. 60).

The cassette is noisier during rewinding or fast-forwarding.

- When using the AC Adaptor, rewind/fast forward speed increases (compared with battery operation) and therefore increases noise. This is not a malfunction.

You cannot operate functions using a "Memory Stick Duo," even if a "Memory Stick Duo" is inserted.

- Slide the POWER switch to turn on the CAMERA-MEMORY or PLAY/EDIT lamp (p. 16).
- If you use a "Memory Stick Duo" formatted on a computer, format it again on your camcorder (p. 51).

You cannot delete the recorded picture on the tape.

- You cannot delete a recorded picture on tape; you can only rewind the tape and record again. The new recording overwrites the existing one.

You cannot delete pictures or format a "Memory Stick Duo."

- Release the lock on the write-protect tab of the "Memory Stick Duo" if there is one (p. 92).
- Cancel image protection on the picture (p. 70).
- The maximum number of pictures that you can delete on the index screen at one time is 100.

Image protection cannot be applied, or you cannot mark pictures for print.

- Release the lock on the write-protect tab of the "Memory Stick Duo" if there is one (p. 92).
- Perform the operation again on the index screen (p. 29, 70).
- The maximum number of pictures you can mark for print is 999.

The data file name is not indicated correctly, or flashes.

- The file is damaged.
- Use the file format compatible with your camcorder (p. 92).

Recording

Refer also to “Cassette tapes/“Memory Stick Duo”” section (p. 80).

The tape does not start when you press START/STOP.

- Slide the POWER switch to turn on the CAMERA-TAPE lamp (p. 23).
- The tape has reached the end. Rewind it, or insert a new cassette.
- Set the write-protect tab to REC or insert a new cassette (p. 91).
- The tape is stuck to the drum due to moisture condensation. Remove the cassette and leave your camcorder for at least 1 hour, then reinsert the cassette (p. 96).

You cannot record on the “Memory Stick Duo.”

- The “Memory Stick Duo” is full. Insert another “Memory Stick Duo” or format the “Memory Stick Duo” (p. 51). Or, delete unnecessary pictures recorded on the “Memory Stick Duo” (p. 69).
- When the POWER switch is set to CAMERA-TAPE, you cannot record still images on the “Memory Stick Duo” with:
 - When [SHUTTR SPEED] is set between 1/725 to 1/10000 second
 - While executing [FADER]
 - [D.EFFECT]
 - [PICT.EFFECT]
 - [SMTH SLW REC]
 - [COLOR BAR]

The recording image view looks different.

- The recording image view may look different depending on the condition of your camcorder. This is not a malfunction.

You cannot record a smooth transition on a tape from the last recorded scene to the next.

- Perform END SEARCH (p. 32).
- Do not remove the cassette (The picture will be recorded continuously without a break even when you turn the power off).
- Do not record pictures in the HDV and DV formats on the same tape.
- Do not record pictures in SP mode and LP mode on the same tape. DV
- Avoid stopping then recording a movie in the LP mode. DV
- When [QUICK REC] is set to [ON], you cannot record a smooth transition (p. 61). HDV1080i

The flash does not work.

- You cannot use the flash during tape recording.
- Even if auto flash or  (Auto redevye reduction) is selected, you cannot use the internal flash with:
 - [TWILIGHT], [CANDLE], [SUNRSE SUNSET], [FIREWORKS], [LANDSCAPE], [SPOTLIGHT], [BEACH] or [SNOW] of [SCENE SELECT]
 - [SPOT MTR-FCS]
 - [SPOT METER]
 - [MANUAL] of [EXPOSURE]

[END SEARCH] does not work.

- Do not eject the cassette after recording (p. 32).
- There is nothing recorded on the cassette.
- There is a blank section between recorded sections of the tape. This is not a malfunction.

[COLOR SLOW S] does not operate correctly.

- [COLOR SLOW S] may not operate correctly in total darkness. Use NightShot or [SUPER NS].
-

You cannot use [SUPER NS].

- The NIGHTSHOT switch is not set to ON (p. 27).
-

The auto focus does not function.

- Set [FOCUS] to [AUTO] (p. 45).
 - The recording conditions are not suitable for auto focus. Adjust the focus manually (p. 45).
-

[STEADYSHOT] does not function.

- Set [STEADYSHOT] to [ON] (p. 48).
-

The backlight function does not function.

- The backlight function does not work during Easy Handycam operation (p. 22).
-

The [FLASH LEVEL] cannot be changed.

- [FLASH LEVEL] (p. 46) cannot be changed during Easy Handycam operation.
-

Tiny spots in white, red, blue, or green appear on the screen.

- The spots appear when the shutter speed is slow or when you are recording in [SUPER NS] or [COLOR SLOW S]. This is not a malfunction.
-

The subjects passing fast by the frame might appear crooked.

- This is called the focal plane phenomenon. This is not a malfunction. Because of the way the image device (CMOS sensor) reads out image signals, the subjects passing in front of the lens rapidly might appear crooked depending on the recording conditions.
-

The color of the picture is not correctly displayed.

- Deactivate the NightShot function (p. 27).
-

The screen picture is bright, and the subject does not appear on the screen.

- Set the NIGHTSHOT switch (p. 27) to OFF, or cancel the backlight function (p. 27).
-

The screen picture is dark, and the subject does not appear on the screen.

- Press and hold DISPLAY/BATT INFO for a few seconds to turn on the backlight (p. 18).
-

Horizontal bands appear.

- This may occur when recording pictures under lighting from a discharge tube, such as a fluorescent lamp, sodium lamp, or mercury lamp. This is not a malfunction.
 - This may be alleviated by adjusting the shutter speed (p. 44).
-

Black bands appear when you record a TV screen or computer screen.

- Adjust [SHUTTR SPEED] (p. 44).
-

Playback

Refer also to “Cassette tapes/“Memory Stick Duo”” section (p. 80).

You cannot play back a tape.

- Slide the POWER switch to turn on the PLAY/EDIT lamp.
- Rewind the tape (p. 28).

You cannot play back in reverse direction.

- Reverse playback is not possible with the tape recorded in the HDV format.

Image data stored on a “Memory Stick Duo” cannot be played back.

- Image data cannot be played back if you have modified file names or folders, or have edited the data on a computer (In this case, the file name flashes). This is not a malfunction (p. 93).
- Pictures recorded on other devices may not be played back or may not appear in their actual size. This is not a malfunction (p. 93).

Horizontal lines appear on the picture. The displayed pictures are not clear or do not appear.

- Clean the head using the cleaning cassette (optional) (p. 97).

You cannot hear the sound recorded with 4CH MIC REC on another camcorder. DV

- Adjust [AUDIO MIX] (p. 57).

Fine patterns flicker, diagonal lines look jagged.

- Adjust [SHARPNESS] to the (softer) side (p. 44).

No sound or only a low sound is heard.

- Turn up the volume (p. 28).
- Adjust [AUDIO MIX] from the [ST2] (additional sound) side until the sound is heard appropriately (p. 57).
- If you are using an S VIDEO plug or component video plug, make sure the red and white plugs of the A/V connecting cable are also connected (p. 34).
- Sounds cannot be recorded while shooting a 3 second-movie (approx.) using [SMTH SLW REC].

The picture or sound breaks off.

- The tape was recorded in both the HDV and DV formats. This is not a malfunction.

The movies freeze for a while, or the sound breaks off.

- This occurs if the tape or video head is dirty (p. 97).
- Use the Sony mini DV cassette.

“----” is displayed on the screen.

- The tape you are playing was recorded without setting the date and time.
- A blank section on the tape is being played.
- The data code on a tape with a scratch or noise cannot be read.

Noises appear and [PAL] or [50i] is displayed on the screen.

- The tape was recorded in a TV color system other than that of your camcorder (NTSC). This is not a malfunction (p. 90).

Date Search does not work correctly.

- Be sure to record more than 2 minutes after the date changed. If one day’s recording is too short, your camcorder may not accurately find the point where the recording date changes.

Troubleshooting (Continued)

- There is a blank section between recorded sections of the tape. This is not a malfunction.

No picture appears during [END SEARCH] or Rec Review.

- The tape was recorded in both HDV and DV formats. This is not a malfunction.

J4ch-12b appears on the LCD screen.

- This appears when you play back a tape recorded on other recording devices using a 4ch microphone (4CH MIC REC). This camcorder does not comply with the 4ch microphone recording standard.

Playing back on TV

You cannot view the picture on the TV connected with the i.LINK cable.

- You cannot view the picture in the HD (high definition) image quality on the TV which is not compatible with the HDV1080i specification (p. 34). Refer to the instruction manuals supplied with your TV.
- Down convert the pictures recorded in HDV format to DV format and play back in SD (standard definition) image quality (p. 59).
- Play back pictures using another connecting cable (p. 34).

You cannot view the picture or hear the sound on the TV connected with the component video cable.

- Set [COMPONENT] on the  (STANDARD SET) menu according to the requirements of the connected device (p. 59).
- When you are using the component video cable, make sure the red and white plugs of the A/V connecting cable are connected (p. 34).

You cannot view the picture or hear the sound on the TV connected with the HDMI cable.

- Pictures in the DV format are not output from the HDMI OUT jack, if copyright protection signals are recorded in the pictures.
- DV format pictures input to the camcorder via i.LINK cable (p. 67) cannot be output.
- This occurs if you record on a tape in both HDV and DV formats. Disconnect and connect the HDMI cable, or slide the POWER switch to turn on your camcorder again.

The picture appears distorted on a 4:3 TV.

- This happens when viewing a picture recorded in the 16:9 (wide) mode on a 4:3 TV. Set [TV TYPE] on the  (STANDARD SET) menu (p. 59) and play back the picture.

Black bands appear at the top and bottom on a 4:3 TV.

- This happens when viewing a picture recorded in 16:9 (wide) mode on a 4:3 TV. This is not a malfunction.

Dubbing/Editing/Connecting to other devices

Pictures from connected devices cannot be zoomed.

- You cannot zoom pictures from connected devices on your camcorder (p. 30).

Time code and other information appear on the display of the connected device.

- Set [DISP OUTPUT] to [LCD PANEL] while connected with an A/V connecting cable (p. 61).

You cannot dub correctly using the A/V connecting cable.

- You cannot input externally from a device connected with the A/V connecting cable.
- The A/V connecting cable is not connected properly.
Make sure that the A/V connecting cable is connected to the input jack of the other device for dubbing a picture from your camcorder.

When connected using an i.LINK cable, no picture appears on the monitor screen or the picture is distorted during dubbing.

- Set [VCR HDV/DV] on the  (STANDARD SET) menu according to the requirements of the connected device (p. 56).
- If the device to be connected is not compatible with HDV1080i specification, you cannot dub in HD (high definition) image quality (p. 64). For details, refer to the instruction manuals supplied with the device to be connected.
- Down convert the pictures recorded in HDV format to DV format and dub in SD (standard definition) image quality (p. 64).

You cannot add sound to the recorded tape.

- You cannot add sound to the recorded tape on this unit.

You cannot dub correctly using the HDMI cable.

- You cannot dub pictures using the HDMI cable.

New sound added to a recorded tape on another camcorder is not heard. DV

- Adjust [ AUDIO MIX] from the [ST1] (original sound) side until the sound is heard appropriately (p. 57).

Still pictures cannot be dubbed from a tape to a “Memory Stick Duo.”

- You cannot record or a distorted picture may be recorded if the tape has been used repeatedly for recording.

Connecting to a computer

The computer does not recognize your camcorder. [\[USB\]](#) [\[i.LINK\]](#)

- Install “Picture Motion Browser” (p. 73).
- Disconnect USB devices other than the keyboard, the mouse, and the camcorder from the  (USB) jack on the computer.
- Disconnect the cable from the computer and camcorder, restart the computer, then connect them again correctly.

You cannot install the supplied software, “Picture Motion Browser,” on a Macintosh computer.

- You cannot use “Picture Motion Browser” on a Macintosh computer.

Functions that cannot be used together

Depending on the functions, you may not be able to use them together. The following list shows examples of menu items and functions that cannot be used at the same time.

Not available	If this function is set
backlight function	[FIREWORKS], [SPOT METER], [MANUAL] of [EXPOSURE]
[SCENE SELECT]	NightShot, [TELE MACRO], [SUPER NS], [CINEMA EFFECT], [OLD MOVIE], [COLOR SLOW S]

Troubleshooting (Continued)

Not available	If this function is set
[SPOT MTR-FCS]	NightShot, [SUPER NS], [CINEMA EFFECT] [SCENE SELECT]
[SPOT METER]	NightShot, [SUPER NS], [CINEMA EFFECT]
[EXPOSURE]	NightShot, [SUPER NS], [CINEMA EFFECT]
[WHITE BAL.]	NightShot, [SUPER NS]
[SHARPNESS]	[CINEMA EFFECT]
[SHUTTR SPEED] of the CAM CTRL dial	NightShot, [SUPER NS], [CINEMA EFFECT], [OLD MOVIE], [SMTH SLW REC]
[AE SHIFT]	[FIREWORKS], [MANUAL] of [EXPOSURE], [CINEMA EFFECT]
[SPOT FOCUS]	[SCENE SELECT]
[TELE MACRO]	[SCENE SELECT], during tape recording
[COLOR SLOW S]	NightShot, [SCENE SELECT], [MANUAL] of [SHUTTR SPEED], [SUPER NS], [FADER], [D.EFFECT]
[HISTOGRAM]	[DIGITAL ZOOM], [D.EFFECT], while displaying the date and time
[DIGITAL ZOOM]	[TELE MACRO]
[FADER]	[CANDLE], [FIREWORKS], [SUPER NS], [COLOR SLOW S], [D.EFFECT]

Not available	If this function is set
[D.EFFECT]	[CANDLE], [FIREWORKS], [SUPER NS], [COLOR SLOW S], [FADER]
[OLD MOVIE] of [D.EFFECT]	[SCENE SELECT], [PICT.EFFECT], when <input checked="" type="checkbox"/> WIDE SELECT is set to [4:3]
[CINEMA EFFECT] of [D.EFFECT]	[SCENE SELECT], [SPOT METER], [MANUAL] of [EXPOSURE], other than 0 in [AE SHIFT], [PICT.EFFECT], when <input checked="" type="checkbox"/> WIDE SELECT is set to [4:3]
[SMTH SLW REC]	[CANDLE], [FIREWORKS], [MANUAL] of [SHUTTR SPEED], [SUPER NS], [COLOR SLOW S], [D.EFFECT], [PICT.EFFECT]

- When [COLOR BAR] is set, all the “Not available” menu items on the list are not available.

Warning indicators and messages

Self-diagnosis display/Warning indicators

If indicators appear on the LCD screen or in the viewfinder, check the following.

Some symptoms you can fix by yourself. If the problem persists even after you have tried a couple of times, contact your Sony dealer or local authorized Sony service facility.

C:(or E:) □□:□□ (Self-diagnosis display)

C:04:□□

- The battery pack is not an “InfoLITHIUM” battery pack (H series). Use an “InfoLITHIUM” battery pack (H series) (p. 93).
- Connect the DC plug of the AC Adaptor to the DC IN jack of your camcorder securely (p. 13).

C:21:□□

- Moisture condensation has occurred. Remove the cassette and leave your camcorder for at least 1 hour, then reinsert the cassette (p. 96).

C:22:□□

- Clean the head using a cleaning cassette (optional) (p. 97).

C:31:□□ / C:32:□□

- Symptoms that are not described above have occurred. Remove and insert the cassette, then operate your camcorder again. Do not perform this procedure if moisture condensation has occurred (p. 96).
- Remove the power source. Reconnect it and operate your camcorder again.
- Change the cassette. Press RESET (p. 104), and operate your camcorder again.

E:61:□□ / E:62:□□ / E:91:□□

- Contact your Sony dealer or local authorized Sony service facility. Inform them of the 5-digit code, which starts from “E.”

101-1001(Warning indicator pertaining to files)

- The file is damaged.
- The file is unreadable (p. 92).

⚡ (Battery level warning)

- The battery pack is nearly used up.
- Depending on the operating environment, or battery conditions, ⚡ may flash, even if there are approximately 5 to 10 minutes remaining.

📀 (Moisture condensation warning)*

- Eject the cassette, remove the power source, and then leave it for about 1 hour with the cassette lid open (p. 96).

📀 (Warning indicator pertaining to “Memory Stick Duo”)

- A “Memory Stick Duo” is not inserted (p. 19).

📀 (Warning indicators pertaining to “Memory Stick Duo” formatting)*

- The “Memory Stick Duo” is damaged.
- The “Memory Stick Duo” is not formatted correctly (p. 51, 92).

📀 (Warning indicator pertaining to incompatible “Memory Stick Duo”)*

- An incompatible “Memory Stick Duo” is inserted (p. 92).

Warning indicators and messages (Continued)

(Warning indicators pertaining to the tape)

Slow flashing:

- There is less than 5 minutes remaining on the tape.
- No cassette is inserted.*
- The write-protect tab on the cassette is set to lock (p. 91).*

Fast flashing:

- The tape has run out.*

(Eject cassette warning)*

Slow flashing:

- The write-protect tab on the cassette is set to lock (p. 91).

Fast flashing:

- Moisture condensation has occurred (p. 96).
- The self-diagnosis display code is displayed (p. 87).

(Warning indicator pertaining to image deletion)*

- The image is protected (p. 70).

(Warning indicator pertaining to the write-protect of the “Memory Stick Duo”)*

- The write-protect tab on the “Memory Stick Duo” is set to lock (p. 92).

(Warning indicator pertaining to the flash)

Slow flashing:

- Still charging

Fast flashing:





- The self-diagnosis display code is displayed (p. 87).*
- There is something wrong with the flash.

* You hear a melody when the warning indicators appear on the screen (p. 61).



Description of warning messages

If messages appear on the screen, follow the instructions.

Tips

- When  is displayed, the message can be turned into  by touching . Touch  to display the message again.

■ Moisture condensation

  **Moisture condensation. Eject the cassette (p. 96)**

 **Moisture condensation. Turn off for 1H. (p. 96)**

■ Cassette/Tape

 **Reinsert the cassette. (p. 19)**

- Check if the cassette is damaged.

  **The tape is locked - check the tab. (p. 91)**

■ “Memory Stick Duo”

Reinsert the Memory Stick. (p. 19)

- Reinsert the “Memory Stick Duo” a few times. If even then the indicator flashes, the “Memory Stick Duo” might be damaged. Try with another “Memory Stick Duo.”
-

This Memory Stick is not formatted correctly.

- Check the format, then format the “Memory Stick Duo” as necessary (p. 51, 92).
-

Memory Stick folders are full.

- You cannot create folders exceeding 999MSDCF. You cannot delete created folders using your camcorder.
 - You will have to format the “Memory Stick Duo” (p. 51), or delete them using your computer.
-

■ Dual Rec

Cannot save still picture.

- Do not eject “Memory Stick Duo” while still images are being stored onto it (p. 25).
-

■ PictBridge compliant printer

Check the connected device.

- Switch off the printer and switch it on again, then disconnect the USB cable and reconnect it.
-

Cannot print. Check the printer.

- Switch off the printer and switch it on again, then disconnect the USB cable and reconnect it.

Using your camcorder abroad

Power supply

You can use your camcorder in any country/region using the AC Adaptor supplied with your camcorder within the AC 100 V to 240 V, 50/60 Hz range. Use a commercially available AC plug adaptor [a], if necessary, depending on the design of the wall outlet (wall socket) [b].

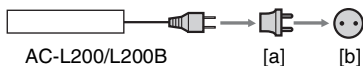

On TV color systems

Your camcorder is NTSC system, so its picture can only be viewed on an NTSC system TV with an AUDIO/VIDEO input jack.

System	Used in
NTSC	Bahama Islands, Bolivia, Canada, Central America, Chile, Colombia, Ecuador, Guyana, Jamaica, Japan, Korea, Mexico, Peru, Surinam, Taiwan, the Philippines, the U.S.A., Venezuela, etc.
PAL	Australia, Austria, Belgium, China, Czech Republic, Denmark, Finland, Germany, Holland, Hong Kong, Hungary, Italy, Kuwait, Malaysia, New Zealand, Norway, Poland, Portugal, Singapore, Slovak Republic, Spain, Sweden, Switzerland, Thailand, United Kingdom, etc.
PAL - M	Brazil
PAL - N	Argentina, Paraguay, Uruguay.
SECAM	Bulgaria, France, Guiana, Iran, Iraq, Monaco, Russia, Ukraine, etc.

Viewing HDV format pictures recorded in HDV format HDV1080i

You need an HDV1080i compatible TV (or monitor) with a component jack and AUDIO/VIDEO input jack. A component video cable and A/V connecting cable are also needed.

Viewing DV format pictures recorded in DV format DV

You need a TV (or monitor) with the AUDIO/VIDEO input jack. A connecting cable is also needed.

Simple setting of the clock by time difference

You can easily set the clock to the local time abroad by entering the time difference between where you live and where you are. Select [WORLD TIME] in the (TIME/LANGU.) menu, then set the time difference (p. 62).

Maintenance and precautions

Usable cassette tapes

Your camcorder is capable of recording in both HDV and DV formats. You can use mini DV format cassettes only. Use a cassette with the Mini DV mark. Your camcorder is not compatible with the Cassette Memory function.

What is the HDV format?

The HDV format is a video format developed to record and play back digital high definition (HD) video signals on a DV cassette.

Your camcorder adopts the Interlace mode with 1,080 effective scan lines of screen ruling (1080i, number of pixels 1,440 × 1,080 dots).

The video bit rate for recording is about 25 Mbps.

i.LINK is adopted for the digital interface, enabling a digital connection with an HDV compatible TV or computer.

Tips

- HDV signals are compressed in MPEG2 format, which is adopted in BS (broadcast satellite) digital, terrestrial digital HDTV broadcastings, in Blu-ray Disc recorders, etc.

Playback

Your camcorder can play back pictures in both the DV format and HDV1080i specification.

Your camcorder can play back pictures recorded in the HDV 720/30p format, but cannot output it from the  HDV/DV Interface (i.LINK).

To prevent a blank section from being created on the tape

Go to the end of the recorded section using END SEARCH (p. 32) before you begin the next recording when you have played back the tape.

Copyright signal

When you play back

If the cassette you play back on your camcorder contains copyright signals, you cannot copy it to a tape in another video camera connected to your camcorder.

When you record

You cannot record software on your camcorder that contains copyright control signals for copyright protection of software. [Cannot record due to copyright protection.] appears on the LCD screen, or on the viewfinder if you try to record such software. Your camcorder does not record copyright control signals on the tape when it records.

Notes on use

When not using your camcorder for a long time

Remove the cassette and store it.

To prevent accidental erasure

Slide the write-protect tab on the cassette to set it to SAVE.

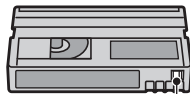

REC: The cassette can be recorded.

SAVE: The cassette cannot be recorded (write-protected).



Maintenance and precautions (Continued)

■ When labeling the cassette

Be sure to place the label only on the locations shown in the following illustration so as not to cause a malfunction of your camcorder.

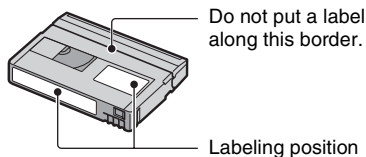

■ After using the cassette

Rewind the tape to the beginning to avoid distortion of the picture or the sound. The cassette should then be put in its case, and stored in an upright position.

■ When cleaning the gold-plated connector

Generally, clean the gold-plated connector on a cassette with a cotton-wool swab after every 10 times it has been ejected. If the gold-plated connector on the cassette is dirty or dusty, the remaining tape indicator may not show correctly.

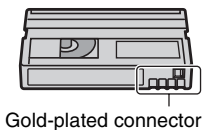

About the "Memory Stick"

A "Memory Stick" is a compact, portable IC recording medium with a large data capacity.

You can use the following types of "Memory Stick" in your camcorder. However, we do not guarantee the operation of all types of "Memory Stick" in your camcorder.

Types of "Memory Stick"	Recording/ Playback
"Memory Stick Duo" (with MagicGate)	○
"Memory Stick PRO Duo"	○
"Memory Stick PRO-HG Duo"	○*

* This product does not support 8-bit parallel data transfer but it supports 4-bit parallel data transfer the same as with Memory Stick PRO Duo.

- This product cannot record or play data that uses "MagicGate" technology. "MagicGate" is a copyright protection technology that records and transfers the contents in an encrypted format.
- This product is compatible with "Memory Stick Micro" ("M2"). "M2" is the abbreviation for the "Memory Stick Micro."
- Still image format: Your camcorder compresses and records image data in the JPEG (Joint Photographic Experts Group) format. The file extension is ".JPG."
- File names of still images:
 - 101-0001: This file name appears on the screen of your camcorder.
 - DSC00001.JPG: This file name appears on the display of a computer.
- A "Memory Stick Duo" formatted by a computer (Windows OS/Mac OS) does not have guaranteed compatibility with your camcorder.
- Data read/write speed may vary depending on the combination of the "Memory Stick" and "Memory Stick" compliant product you use.
- You can prevent accidental erasure of images when you slide the write-protect tab on the "Memory Stick Duo" with a small tapered object, to the write-protect position.
- Damaged or lost image data will not be compensated for, and may occur in the following cases:
 - If you eject the "Memory Stick Duo," turn the power off on your camcorder, or remove the battery pack for replacement while your camcorder is reading or writing image files on the "Memory Stick Duo" (while the access lamp is lit or flashing).
 - If you use the "Memory Stick Duo" near magnets or magnetic fields.

- It is recommended you make a back-up of important data on the hard disk of a computer.
- Be careful not to apply excessive force when writing on a memo area on a “Memory Stick Duo.”
- Do not attach a label or the like on a “Memory Stick Duo” or a Memory Stick Duo adaptor.
- When you carry or store a “Memory Stick Duo,” put it in its case.
- Do not touch, or allow metallic objects to come into contact with the terminals.
- Do not bend, drop or apply strong force to the “Memory Stick Duo.”
- Do not disassemble or modify the “Memory Stick Duo.”
- Do not let the “Memory Stick Duo” get wet.
- Be careful to keep “Memory Stick Duo” media out of the reach of small children. There is danger that a child might swallow it.
- Do not insert anything other than a “Memory Stick Duo” into the Memory Stick Duo slot. Doing so may cause a malfunction.
- Do not use or keep the “Memory Stick Duo” in the following locations.
 - Places subject to extremely high temperature, such as a car parked outside in the summer.
 - Places under direct sunlight.
 - Places with extremely high humidity or subject to corrosive gases.

■ On the Memory Stick Duo adaptor

- When using a “Memory Stick Duo” with a “Memory Stick” compliant device, be sure to insert the “Memory Stick Duo” into a Memory Stick Duo adaptor.
- When inserting a “Memory Stick Duo” into a Memory Stick Duo adaptor, make sure the “Memory Stick Duo” is inserted facing in the correct direction, then insert it all the way in. If you force the “Memory Stick Duo” into the Memory Stick Duo adaptor in the wrong direction or insert it incompletely, it may cause a malfunction.
- Do not insert a Memory Stick Duo adaptor without a “Memory Stick Duo” attached. Doing so may result in malfunctions of the unit.

■ On a “Memory Stick PRO Duo”

- The maximum memory capacity of a “Memory Stick PRO Duo” that can be used on your camcorder is 8 GB.



Notes on using “Memory Stick Micro”

- To use a “Memory Stick Micro” with the VCR, you need a Duo-sized M2 Adaptor. Insert the “Memory Stick Micro” into the Duo-sized M2 Adaptor, then insert the adaptor into the Memory Stick Duo slot. If you insert a “Memory Stick Micro” into the VCR without using a Duo-sized M2 Adaptor, you might not be able to remove it from the VCR.
- Do not leave the “Memory Stick Micro” within the reach of small children. They might accidentally swallow it.

On image data compatibility

- Image data files recorded on a “Memory Stick Duo” by your camcorder conform to the “Design rule for Camera File system” universal standard established by the JEITA (Japan Electronics and Information Technology Industries Association).
- On your camcorder, you cannot play back still images recorded on other devices (DCR-TRV900 or DSC-D700/D770) that do not conform to the universal standard (These models are not sold in some regions).
- If you cannot use a “Memory Stick Duo” that has been used with another device, format it with your camcorder (p. 51). Note that formatting erases all information on the “Memory Stick Duo.”
- You may not be able to play back images with your camcorder:
 - When playing back image data modified on your computer.
 - When playing back image data recorded with other devices.

About the “InfoLITHIUM” battery pack

This unit is compatible with an “InfoLITHIUM” battery pack (H series). Your camcorder operates only with an “InfoLITHIUM” battery pack. “InfoLITHIUM” H series battery packs have the   mark.

Maintenance and precautions (Continued)

What is an “InfoLITHIUM” battery pack?

An “InfoLITHIUM” battery pack is a lithium-ion battery pack that has functions for communicating information related to operating conditions between your camcorder and an optional AC Adaptor/charger.

The “InfoLITHIUM” battery pack calculates the power consumption according to the operating conditions of your camcorder, and displays the remaining battery time in minutes.

With an AC Adaptor/charger, the remaining battery time and charging time appear.

To charge the battery pack

- Be sure to charge the battery pack before you start using your camcorder.
- We recommend charging the battery pack in an ambient temperature of between 10 °C to 30 °C (50 °F to 86 °F) until the  /CHG (charge) lamp turns off. If you charge the battery pack outside of this temperature range, you may not be able to charge it efficiently.
- After charging is complete, disconnect the cable from the DC IN jack on your camcorder or remove the battery pack.

To use the battery pack effectively

- Battery pack performance decreases when the surrounding temperature is 10 °C (50 °F) or below, and the length of time you can use the battery pack becomes shorter. In that case, do one of the following to use the battery pack for a longer time.
 - Put the battery pack in a pocket to warm it up, and insert it in your camcorder right before you start taking shots.
 - Use a large capacity battery pack: NP-FH70/ FH100 (optional).
- Frequent use of the LCD screen or a frequent playback, fast forward or rewind operation wears out the battery pack faster.

We recommend using a large capacity battery pack: NP-FH70/FH100 (optional).
- Be sure to set the POWER switch to OFF (CHG) when not recording or playing back on your camcorder. The battery pack is also

consumed when your camcorder is in recording standby or playback pause.

- Have spare battery packs ready for two or three times the expected recording time, and make trial recordings before making the actual recording.
- Do not expose the battery pack to water. The battery pack is not water resistant.

About the remaining battery time indicator

- When the power goes off even though the remaining battery time indicator indicates that the battery pack has enough power to operate, charge the battery pack fully again. Remaining battery time will be indicated correctly. Note, however, that the battery indication will not be restored if it is used in high temperatures for a long time, or if left in a fully charged state, or when the battery pack is frequently used. Use the remaining battery time indication as a rough guide only.
- The  mark that indicates low battery flashes even if there are still 5 to 10 minutes of battery time remaining, depending on the operating conditions or ambient temperature.

About storage of the battery pack

- If the battery pack is not used for a long time, fully charge the battery pack and use it up on your camcorder once a year to maintain proper function. To store the battery pack, remove it from your camcorder and put it in a dry, cool place.
- To discharge the battery pack on your camcorder completely, set [A.SHUT OFF] to [NEVER] on the  (STANDARD SET) menu and leave your camcorder in tape recording standby until the power goes off (p. 61).

About battery life

- Battery capacity decreases over time and through repeated use. If decreased usage time between charges becomes significant, it is probably time to replace it with a new one.
- Each battery's life is governed by storage, operating and environmental conditions.

About i.LINK

The HDV/DV Interface on this unit is an i.LINK-compliant Interface. This section describes the i.LINK standard and its features.

What is i.LINK?

i.LINK is a digital serial interface for transferring digital video, digital audio, and other data to other i.LINK-compatible devices. You can also control other devices using the i.LINK.

i.LINK-compatible devices can be connected using an i.LINK cable. Possible applications are operations and data transactions with various digital AV devices.

When two or more i.LINK-compatible devices are daisy-chained with the unit, operation becomes possible from any device in the chain. Note that operation method may vary, or data transactions may not be possible, depending on specifications and characteristics of the connected devices.

Notes

- Normally, only one device can be connected to this unit with an i.LINK cable. When connecting this unit to an HDV/DV compatible device having two or more i.LINK HDV/DV Interfaces, refer to the operating instructions of the device to be connected.

Tips

- i.LINK is a more familiar term for the IEEE1394 data transport bus proposed by Sony, and is a trademark approved by many corporations.
- IEEE1394 is an international standard standardized by the Institute of Electrical and Electronics Engineers.

About the i.LINK Baud rate

i.LINK's maximum baud rate varies according to the device. There are 3 types.

S100 (approx. 100Mbps*)

S200 (approx. 200Mbps)

S400 (approx. 400Mbps)

The baud rate is listed under "Specifications" in the operating instructions of each piece of equipment. It is also indicated near the i.LINK interface on some devices.

The baud rate may differ from the indicated value when the unit is connected to a device with a different maximum baud rate.

* What is Mbps?

Mbps stands for "megabits per second," or the amount of data that can be sent or received in one second. For example, a baud rate of 100 Mbps means that 100 megabits of data can be sent in one second.

To use i.LINK functions on this unit

For details on how to dub when this unit is connected to other video devices having an i.LINK Interface, see page 64.

This unit can also be connected to other i.LINK-compatible devices made by Sony (e.g. a VAIO series personal computer) as well as to video devices.

Some i.LINK compatible video devices, such as Digital Televisions, DVD, MICROMV or HDV recorders/players are not compatible with this unit. Before connecting to other devices, be sure to confirm whether the device is compatible with an HDV/DV device or not. For details on precautions and compatible application software, refer also to the operating instructions for the device to be connected.

Notes

- When connecting your camcorder to another i.LINK-compatible device, be sure to turn off the power of the device and disconnect the AC Adaptor from the wall outlet (wall socket) before connecting or disconnecting the i.LINK cable.

Maintenance and precautions (Continued)

About the required i.LINK cable

Use the Sony i.LINK 4-pin-to-4-pin cable (during HDV/DV dubbing).

About x.v.Color

- x.v.Color is a more familiar term for the xvYCC standard proposed by Sony, and is a trademark of Sony.
- xvYCC is an international standard for color space in video. This standard can express a wider color range than the currently used broadcast standard.

On using your camcorder

On use and care

- Do not use or store the camcorder and accessories in the following locations.
 - Anywhere extremely hot or cold. Never leave them exposed to temperatures above 60 °C (140 °F), such as under direct sunlight, near heaters or in a car parked in the sun. They may malfunction or become deformed.
 - Near strong magnetic fields or mechanical vibration. The camcorder may malfunction.
 - Near strong radio waves or radiation. The camcorder may not be able to record properly.
 - Near AM receivers and video equipment. Noise may occur.
 - On a sandy beach or anywhere dusty. If sand or dust gets in your camcorder, it may malfunction. Sometimes this malfunction cannot be repaired.
 - Near windows or outdoors, where the LCD screen, the viewfinder, or the lens may be exposed to direct sunlight. This damages the inside of the viewfinder or the LCD screen.
 - Anywhere very humid.
- Operate your camcorder on DC 6.8 V/7.2 V (battery pack) or DC 8.4 V (AC Adaptor).
- For DC or AC operation, use the accessories recommended in these operating instructions.
- Do not let your camcorder get wet, for example, from rain or sea water. If your camcorder gets wet, it may malfunction. Sometimes this malfunction cannot be repaired.
- If any solid object or liquid gets inside the casing, unplug your camcorder and have it



checked by a Sony dealer before operating it any further.

- Avoid rough handling, disassembling, modifying, physical shock, or impact such as hammering, dropping or stepping on the product. Be particularly careful of the lens.
- Keep the POWER switch setting to OFF (CHG) when you are not using your camcorder.
- Do not wrap your camcorder with a towel, for example, and operate it. Doing so might cause heat to build up inside.
- When disconnecting the power cord (mains lead), pull it by the plug and not the cord.
- Do not damage the power cord (mains lead) such as by placing anything heavy on it.
- Keep metal contacts clean.
- Keep the Remote Commander and button-type battery out of children's reach. If the battery is accidentally swallowed, consult a doctor immediately.
- If the battery electrolytic liquid has leaked,
 - consult your local authorized Sony service facility.
 - wash off any liquid that may have contacted your skin.
 - if any liquid gets in your eyes, wash with plenty of water and consult a doctor.

■ When not using your camcorder for a long time



- Periodically turn on the camcorder and play a cassette for about 3 minutes.
- Use up the battery pack completely before storing it.

Moisture condensation

If your camcorder is brought directly from a cold place to a warm place, moisture may condense inside your camcorder, on the surface of the tape, or on the lens. In this state, the tape may stick to the head drum and be damaged or your camcorder may not operate correctly. If there is moisture inside your camcorder, [  Moisture condensation. Eject the cassette] or [ Moisture condensation. Turn off for 1H.] appears. The indicator will not appear when the moisture condenses on the lens.

■ If moisture condensation has occurred

None of the functions except cassette ejection will work. Eject the cassette, turn off your camcorder, and leave it for about one hour with the cassette lid open. Your camcorder can be used again when both of the following conditions are met:

- The warning message does not appear when the power is turned on.
- Neither  or  flash when a cassette is inserted and video operation buttons are touched.

If moisture starts to condense, your camcorder sometimes cannot detect condensation. If this happens, the cassette is sometimes not ejected for 10 seconds after the cassette lid is opened. This is not a malfunction. Do not close the cassette lid until the cassette is ejected.

■ Note on moisture condensation

Moisture may condense when you bring your camcorder from a cold place into a warm place (or vice versa) or when you use your camcorder in a humid place as shown below.

- When you bring your camcorder from a ski slope into a place warmed up by a heating device.
- When you bring your camcorder from an air conditioned car or room into a hot place outside.
- When you use your camcorder after a squall or a shower.
- When you use your camcorder in a hot and humid place.

■ How to avoid moisture condensation

When you bring your camcorder from a cold place into a warm place, put your camcorder in a plastic bag and seal it tightly. Remove the bag when the air temperature inside the plastic bag has reached the surrounding temperature (after about one hour).

Video head

If you play back a tape recorded in HDV format, the image and sound may freeze for a while (about 0.5 seconds).

This occurs if the HDV signals cannot be recorded or played back correctly because of dirt on the tape or video head. Depending on the cassette, this fairly infrequently occurs even if the cassette is brand new or is not used a lot.

If this freezing point is created while playing back, you can solve this problem and see the pictures by rewinding after slightly forwarding. Such a freezing point cannot be recovered if it was created while recording.

To prevent such a problem, use the Sony mini DV cassette. It is recommended you use a cleaning cassette (optional) before recording anything important.

- If the following problem occurs, clean the video heads for 10 seconds with the Sony DVM-12CLD cleaning cassette (optional).
 - Playback pictures do not move.
 - Playback pictures do not appear.
 - The sound breaks off.
 -  Dirty video head. Use a cleaning cassette.] appears on the screen during recording.
 - The following phenomenon occurs in HDV format.



The playback screen pauses.



The playback screen goes blank. (Solid blue screen)

- The following phenomenon occurs in DV format.



Block-noise appears.



Maintenance and precautions (Continued)



The playback screen goes blank.
(Solid blue screen)

- The video heads will degrade after long use. If you cannot obtain a clear image even after using a cleaning cassette (optional), it might be because the video heads are worn out. Please contact your Sony dealer or local authorized Sony service facility to have the video heads replaced.

LCD screen

- Do not exert excessive pressure on the LCD screen, as it may cause damage.
- If your camcorder is used in a cold place, a residual image may appear on the LCD screen. This is not a malfunction.
- While using your camcorder, the back of the LCD screen may heat up. This is not a malfunction.

■ To clean the LCD screen

If fingerprints or dust make the LCD screen dirty, it is recommended you use a soft cloth to clean it. When you use the LCD Cleaning Kit (optional), do not apply the cleaning liquid directly to the LCD screen. Use cleaning paper moistened with the liquid.

■ On adjustment of the touch panel (CALIBRATION)

The buttons on the touch panel may not work correctly. If this happens, follow the procedure below. It is recommended you connect your camcorder to the wall outlet (wall socket) using the supplied AC Adaptor during the operation.

- ① Slide the POWER switch repeatedly to turn on the PLAY/EDIT lamp.
- ② Touch [P-MENU] → [MENU] →  (STANDARD SET) → [CALIBRATION] → [OK].

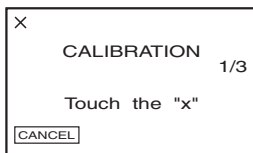

- ③ Touch the “x” displayed on the screen with the corner of the “Memory Stick Duo” or the like.

The position of the “x” changes.

To cancel, touch [CANCEL].

If you did not press the right spot, start from step ③ again.

🔊 Notes

- You cannot calibrate the LCD screen if it is rotated.

On handling the casing

- If the casing is soiled, clean the camcorder body with a soft cloth lightly moistened with water, and then wipe the casing with a dry soft cloth.
- Avoid the following to avoid damage to the finish.
 - Using chemicals such as thinner, benzine, alcohol, chemical cloths, repellent, insecticide and sunscreen.
 - Handling with above substances on your hands.
 - Leaving the casing in contact with rubber or vinyl objects for a long period of time.

About care and storage of the lens

- Wipe the surface of the lens clean with a soft cloth in the following instances:
 - When there are fingerprints on the lens surface.
 - In hot or humid locations
 - When the lens is exposed to salty air such as at the seaside.
- Store in a well-ventilated location subject to little dirt or dust.
- To prevent mold, periodically clean the lens as described above. It is recommended that you operate your camcorder about once a month to keep it in optimum state for a long time.

Specifications

On charging the pre-installed rechargeable battery

Your camcorder has a pre-installed rechargeable battery to retain the date, time, and other settings even when the POWER switch is set to OFF (CHG). The pre-installed rechargeable battery is always charged while your camcorder is connected to the wall outlet (wall socket) via the AC Adaptor or while the battery pack is inserted. The rechargeable battery will be fully discharged in **about 3 months** if you do not use your camcorder at all without the AC Adaptor connected or the battery pack attached. Use your camcorder after charging the pre-installed rechargeable battery.

However, even if the pre-installed rechargeable battery is not charged, the camcorder operation will not be affected as long as you are not recording the date.

■ Procedures

Connect your camcorder to a wall outlet (wall socket) using the supplied AC Adaptor, and leave it with the POWER switch set to OFF (CHG) for more than 24 hours.

System

Video recording system (HDV)

2 rotary heads, Helical scanning system

Video recording system (DV)

2 rotary heads, Helical scanning system

Still image recording system

Exif Ver. 2.2*1

Audio recording system (HDV)

Rotary heads, MPEG-1 Audio Layer -2,
Quantization: 16 bits (Fs 48 kHz,
stereo)

transfer rate: 384 kbps

Audio recording system (DV)

Rotary heads, PCM system
Quantization: 12 bits (Fs 32 kHz, stereo
1, stereo 2), 16 bits (Fs 48 kHz, stereo)

Video signal

NTSC color, EIA standards
1080/60i specification

Usable cassette

Mini DV cassette with the ^{Mini} DV mark printed

Tape speed (HDV)

Approx. 18.81 mm/s

Tape speed (DV)

SP: Approx. 18.81 mm/s

LP: Approx. 12.56 mm/s

Recording/playback time (HDV)

60 min (using a DVM60 cassette)

Recording/playback time (DV)

SP: 60 min (using a DVM60 cassette)

LP: 90 min (using a DVM60 cassette)

Fast forward/rewind time

Approx. 2 min 40 s (using a DVM60
cassette and rechargeable battery pack)

Approx. 1 min 45 s (using a DVM60
cassette and AC Adaptor)

Viewfinder

Electric viewfinder (color)

Specifications (Continued)

Image device

6.3 mm (1/2.9 type) CMOS sensor
Recording pixels (still, 4:3):
Max. 6.1 mega (2 848 × 2 136) pixels*²
Gross: Approx. 3 200 000 pixels
Effective (movie, 16:9):
Approx. 2 280 000 pixels
Effective (movie, 4:3):
Approx. 1 710 000 pixels
Effective (still, 16:9):
Approx. 2 280 000 pixels
Effective (still, 4:3):
Approx. 3 040 000 pixels

Lens

Carl Zeiss Vario-Sonnar T*
10 × (Optical), 20 × (Digital)

Focal length

f=5.4 ~ 54 mm (7/32 ~ 2 1/4 in.)
When converted to a 35 mm still camera
In CAMERA-TAPE: 40 ~ 400 mm
(1 5/8 ~ 15 3/4 in.) (16:9), 49 ~ 490 mm
(1 15/16 ~ 19 3/8 in.) (4:3)
In CAMERA-MEMORY: 40 ~ 400 mm
(1 5/8 ~ 15 3/4 in.) (16:9), 37 ~ 370 mm
(1 1/2 ~ 14 5/8 in.) (4:3)
F1.8 ~ 2.9
Filter diameter: 37 mm (1 1/2 in.)

Color temperature

[AUTO], [ONE PUSH], [INDOOR]
(3 200 K),
[OUTDOOR] (5 800 K)

Minimum illumination

5 lx (lux) ([AUTOSLW SHTR] [ON],
Shutter speed 1/30 sec)
0 lx (lux) (during NightShot function)

*1“Exif” is a file format for still images,
established by the JEITA (Japan
Electronics and Information Technology
Industries Association). Files in this
format can have additional information
such as your camcorder’s setting
information at the time of recording.

*²The unique pixel array of Sony’s
ClearVid CMOS sensor and image
processing system (new Enhanced
Imaging Processor) allows for still
image resolution equivalent to the sizes
described.

Input/Output connectors

Audio/Video output

10-pin connector
Video signal: 1 V_{p-p}, 75 Ω (ohms)
Luminance signal: 1 V_{p-p}, 75 Ω (ohms)
Chrominance signal: 0.286 V_{p-p}, 75 Ω
(ohms)
Audio signal: 327 mV (at load
impedance 47 kΩ (kilohms)), Output
impedance with less than 2.2 kΩ
(kilohms)

COMPONENT OUT jack

Y: 1 V_{p-p}, 75 Ω (ohms)
PB/PR, CB/CR: ± 350 mV, 75 Ω (ohms)

HDMI OUT jack

TypeA (19-pin)

Headphone jack

Stereo minijack (Ø 3.5 mm)

LANC jack

Stereo mini-minijack (Ø 2.5 mm)

USB jack

mini-B

MIC (PLUG IN POWER) jack

Stereo minijack (Ø 3.5 mm)

⏏ HDV/DV jack

i.LINK Interface (IEEE1394, 4-pin
connector S100)

LCD screen

Picture

6.7 cm (2.7 type, aspect ratio 16:9)

Total dot number

211 200 (960 × 220)

General

Power requirements

- DC 6.8 V/7.2 V (battery pack)
- DC 8.4 V (AC Adaptor)

Average power consumption

- During camera recording using the viewfinder with normal brightness:
 - HDV recording 4.2 W
 - DV recording 4.0 W
- During camera recording using the LCD with normal brightness:
 - HDV recording 4.5 W
 - DV recording 4.3 W

Operating temperature

- 0 °C to + 40 °C (32 °F to 104 °F)

Storage temperature

- 20 °C to + 60 °C (-4 °F to + 140 °F)

Dimensions (approx.)

- 82 × 82 × 138 mm
(3 1/4 × 3 1/4 × 5 1/2 in.) (w/h/d)
including the projecting parts
- 82 × 82 × 138 mm
(3 1/4 × 3 1/4 × 5 1/2 in.) (w/h/d)
including the projecting parts with the supplied battery pack NP-FH60 attached

Mass (approx.)

- 550 g (1 lb 3 oz) main unit only
- 650 g (1 lb 6 oz) including the NP-FH60 rechargeable battery pack and DVM60 cassette.

Supplied accessories

- See page 12.

AC Adaptor AC-L200/L200B

Power requirements

- AC 100 V - 240 V, 50/60 Hz

Current consumption

- 0.35 - 0.18 A

Power consumption

- 18 W

Output voltage

- DC 8.4 V*

Operating temperature

- 0 °C to + 40 °C (32 °F to 104 °F)

Storage temperature

- 20 °C to + 60 °C (-4 °F to + 140 °F)

Dimensions (approx.)

- 48 × 29 × 81 mm (1 15/16 × 1 3/16 × 3 1/4 in.) (w/h/d) excluding the projecting parts

Mass (approx.)

- 170 g (6.0 oz) excluding the power cord (mains lead)

- * See the label on the AC Adaptor for other specifications.

Rechargeable battery pack (NP-FH60)

Maximum output voltage

- DC 8.4 V

Output voltage

- DC 7.2 V

Capacity

- 7.2 Wh (1 000 mAh)

Dimensions (approx.)

- 31.8 × 33.3 × 45.0 mm
(1 5/16 × 1 5/16 × 1 13/16 in.) (w/h/d)

Mass (approx.)

- 80 g (2.9 oz)

Operating temperature

- 0 °C to + 40 °C (32 °F to 104 °F)

Type

- Lithium ion

- Design and specifications are subject to change without notice.

Specifications (Continued)

On trademarks

- “Handycam” and  are registered trademarks of Sony Corporation.
- HDV and the HDV logo are trademarks of Sony Corporation and Victor Company of Japan, Ltd.
- “Memory Stick,”  “Memory Stick Duo,” “**MEMORY STICK DUO**,” “Memory Stick PRO Duo,” “**MEMORY STICK PRO DUO**,” “Memory Stick PRO-HG Duo,” “**MEMORY STICK PRO-HG DUO**,” “Memory Stick Micro,” “MagicGate,” “**MAGIC GATE**,” “MagicGate Memory Stick” and “MagicGate Memory Stick Duo” are trademarks of Sony Corporation.
- “InfoLITHIUM” is a trademark of Sony Corporation.
- i.LINK and  are trademarks of Sony Corporation.
- Mini  Digital Video Cassette is a trademark.
- “x.v.Color” is a trademark of Sony Corporation.
- Microsoft, Windows, Windows Media, Windows Vista, and DirectX are trademarks or registered trademarks of U.S. Microsoft Corporation in the U.S. and other countries.
- Macintosh and Mac OS are trademarks of Apple Inc. in the U.S. and other countries.
- HDMI, the HDMI logo, and High-Definition Multimedia Interface are trademarks or registered trademarks of HDMI Licensing LLC.
- Intel, Intel Core and Pentium are either registered trademarks or trademarks of Intel Corporation and its subsidiaries in the United States and/or other countries.
- Adobe and Adobe Reader are either registered trademarks or trademarks of Adobe Systems Incorporated in the United States and/or other countries.

All other product names mentioned herein may be the trademarks or registered trademarks of their respective companies. Furthermore, TM and “®” are not mentioned in each case in this manual.

Notes on the License

ANY USE OF THIS PRODUCT OTHER THAN CONSUMER PERSONAL USE IN ANY MANNER THAT COMPLIES WITH THE MPEG-2 STANDARD FOR ENCODING VIDEO INFORMATION FOR PACKAGED MEDIA IS EXPRESSLY PROHIBITED WITHOUT A LICENSE UNDER APPLICABLE PATENTS IN THE MPEG-2 PATENT PORTFOLIO, WHICH LICENSE IS AVAILABLE FROM MPEG LA, L.L.C., 250 STEELE STREET, SUITE 300, DENVER, COLORADO 80206.

Identifying parts and controls

The numbers in () are reference pages.

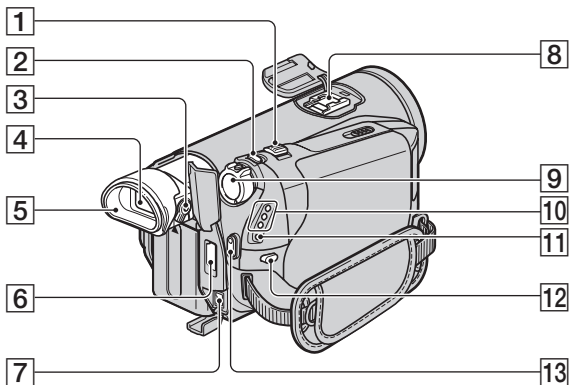

- 1** Power zoom lever (25)
- 2** PHOTO button (24)
- 3** Viewfinder lens adjustment lever (18)
- 4** Viewfinder (18)
- 5** Eyecup
- 6** HDMI OUT jack (Output only) (34)
 - The available video signals are read, and the appropriate output format is selected and output automatically.
 - You can check the setup value of HDMI OUTPUT on [STATUS CHECK] (p. 59).

7 DC IN jack (13)

- 8** Active Interface Shoe Active Interface Shoe
The Active Interface Shoe supplies power to optional accessories such as a video light, a flash, or a microphone. The accessory can be turned on or off as you operate the POWER switch on your camcorder. Refer to the operating instructions supplied with your accessory for details.

- When you connect an accessory, open the shoe cover.

- The Active Interface Shoe has a safety device for fixing the installed accessory securely. To connect an accessory, press down and push it to the end, and then tighten the screw. To remove an accessory, loosen the screw, and then press down and pull out the accessory.
- Connecting with an external device wears out the battery pack faster.
- When you are recording movies with an external flash (optional) connected to the accessory shoe, turn off the power of the external flash to prevent charging noise being recorded.
- You cannot use an external flash (optional) and the built-in flash at the same time.

9 POWER switch (16)

10 CAMERA-TAPE, CAMERA-MEMORY, PLAY/EDIT mode lamps (16)





11 ζ /CHG (charge) lamp (13)

12 ζ (flash) button (26)

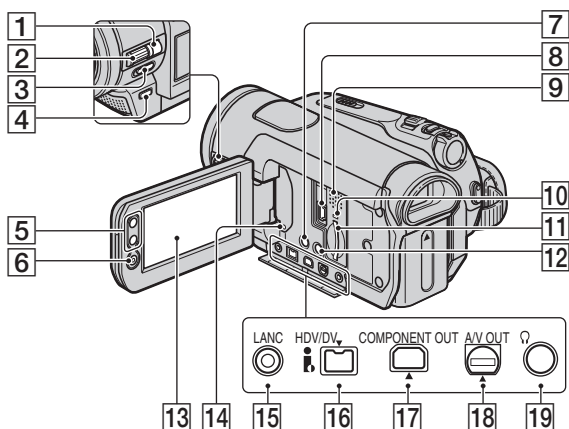
13 START/STOP button (23)

Identifying parts and controls (Continued)



- 1** MANUAL button (26)
- 2** CAM CTRL dial (26)
- 3** NIGHTSHOT switch (27)
- 4**  (back light) button (27)
- 5** Zoom buttons (25)
- 6** START/STOP button (23)
- 7** DISPLAY/BATT INFO button (14)
- 8**  (USB) jack (71)
- 9** Speaker
Playback sounds come out from the speaker. For how to adjust the volume, see page 28.
- 10** Access lamp (19, 92)
- 11** Memory Stick Duo slot (19)
- 12** EASY button (21)
- 13** LCD screen/touch panel (6, 18)
- 14** RESET button
Initializes all the settings, including the setting of the date and time (Menu items customized on Personal Menu are not initialized).
- 15**  LANC jack (blue)
The LANC control jack is used for controlling the tape transport of video devices and peripherals connected to it.
- 16**  HDV/DV Interface (i.LINK) (34, 65, 67, 75)
- 17** COMPONENT OUT jack (34)
- 18** A/V (audio/video) OUT jack (34, 65)
- 19**  (Headphone) jack (green)

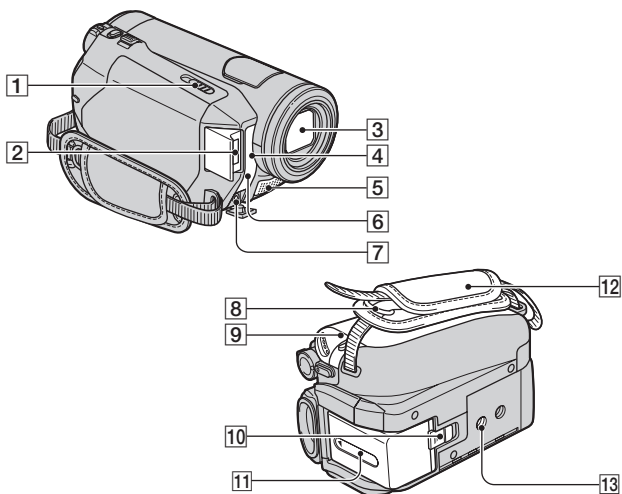

- 1** OPEN/EJECT lever (19)
- 2** Flash
- 3** Lens (Carl Zeiss Lens) (7)
- 4** Remote sensor/Infrared port
Point the Remote Commander (p. 106) towards the remote sensor to operate your camcorder.
- 5** Microphone
An Active Interface Shoe compatible microphone (optional) will take precedence when connected.
- 6** REC lamp (Camera recording lamp)
 - The REC lamp lights up in red during recording (p. 61).
 - The REC lamp flashes if the remaining tape or battery power is low.
- 7** MIC (PLUG IN POWER) jack
When an external microphone (optional) is connected, it takes precedence over the internal microphone (p. 105).
- 8** Hook for the Shoulder belt
Attach the Shoulder belt (optional).
- 9** Cassette compartment lid (19)
- 10** BATT (battery release) lever (14)
- 11** Battery pack (13)
- 12** Grip belt (18)
- 13** Tripod receptacle
Attach the tripod (optional: the length of the screw must be less than 5.5 mm (7/32 in.)) to the tripod receptacle using a tripod screw.

Attaching the supplied lens hood

Place the lens hood against the lens hood receptacle of the camcorder, and turn it in the direction of the arrow.

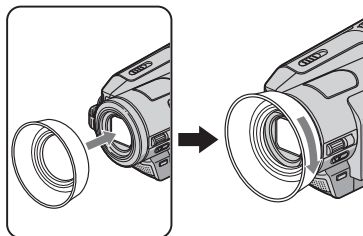

Identifying parts and controls (Continued)

To remove the lens hood

Loosen the lens hood by turning it in the opposite direction of the arrow in the illustration above.

- Remove the lens hood when you use the flash, Nightshot or SuperNightshot, or its shadow will appear in the picture.

Remote Commander

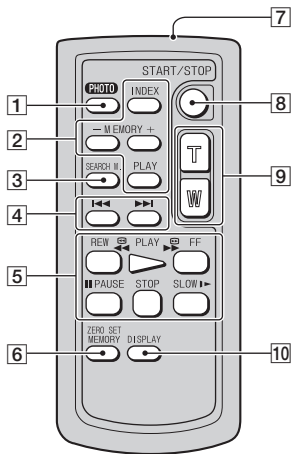

Insulation sheet

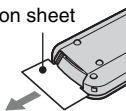

- 1** PHOTO button (24)
The on-screen image when you press this button will be recorded onto the “Memory Stick Duo” as a still image.
- 2** Memory control buttons (Index*, -/+, Memory playback) (29)
- 3** SEARCH M. button* (33)
- 4** ◀▶ (Previous/Next) buttons* (33)

- 5** Video control buttons (Rewind, Playback, Fast-forward, Pause, Stop, Slow) (28)
- 6** ZERO SET MEMORY button* (32)
- 7** Transmitter
- 8** START/STOP button (21, 23)
- 9** Power zoom buttons (25, 30)
- 10** DISPLAY button (18)

* These buttons are not available during Easy Handycam operation.

Notes

- Remove the insulation sheet before using the Remote Commander.
- Aim the Remote Commander towards the remote sensor to operate your camcorder (p. 105).

To change the battery of the Remote Commander

- While pressing on the tab, insert your fingernail into the slit to pull out the battery case.
- Place a new battery with the + side facing up.
- Insert the battery case back into the Remote Commander until it clicks.

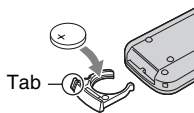

WARNING

Battery may explode if mistreated. Do not recharge, disassemble or dispose of in fire.

Notes

- When the lithium battery becomes weak, the operating distance of the Remote Commander may shorten, or the Remote Commander may not function properly. In this case, replace the battery with a Sony CR2025 lithium battery. Use of another battery may present a risk of fire or explosion.

Indicators displayed during recording/playback

Recording movies

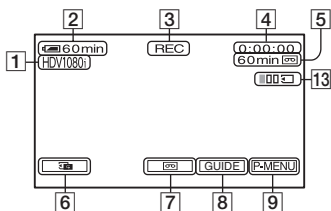

Recording still images

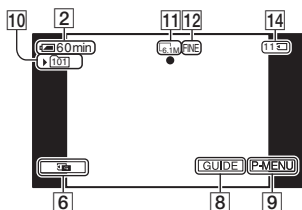

Viewing movies

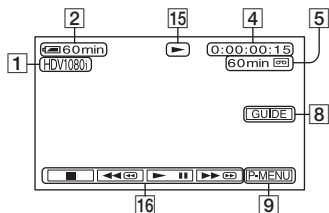

Viewing still images

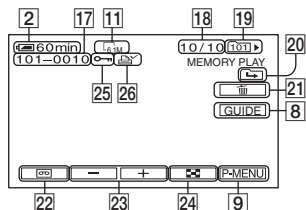

- 1 Recording format (HDV1080i or DV) (57)
Recording mode (SP or LP) is also displayed in the DV format.
- 2 Remaining battery (approx.)
- 3 Recording status ([STBY] (standby) or [REC] (recording))
- 4 During recording:
Tape counter (hour: minute: second)
During playback:
Time code (hour: minute: second: frame)
- 5 Recording capacity of the tape (approx.) (60)
- 6 Review button for still images on the "Memory Stick Duo" (24)
Appears when "Memory Stick Duo" is inserted.
- 7 END SEARCH/Rec review display switch button (32)
- 8 GUIDE button (110)
- 9 Personal Menu button (39)
- 10 Recording folder (51)
- 11 Image size (49)
- 12 Quality ([FINE] or [STD]) (49)
- 13 Number of recorded still images (25)
- 14 "Memory Stick Duo" indicator and the number of images that can be recorded (approx.)

Tips

- The date/time during recording and the camera setting data will be recorded automatically. They do not appear on the screen during recording, but you can check them as [DATA CODE] during playback (p. 60).



- 15 Tape transport indicator
- 16 Video operation buttons (28)
- 17 Data file name
- 18 Picture number/Total number of recorded pictures in the current playback folder



Indicators displayed during recording/playback (Continued)



19 Playback folder (51)

20 Previous/Next folder icon

The following indicators appear when the first or last picture of the current folder is displayed and when there are multiple folders on the same “Memory Stick Duo.”

 : Touch  to move to the previous folder.

 : Touch  to move to the next folder.

 : Touch / to move to either the previous or the next folder.

21 Image delete button (69)

22 Tape playback select button (29)

23 Previous/Next image button (29)

24 Index screen display button (29)

25 Image protection mark (70)

26 Print mark (70)

Indicators when you made changes

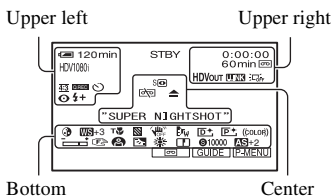

Upper left

Indicator	Meaning
HDV1080i DV	Recording format (56)
16b	AUDIO MODE* (57)
SP LP	Recording mode* (57)
⌚	Self-timer recording (48)
43	WIDE SELECT* (57)
Q.REC	QUICK REC** (61)
📷	Interval photo recording (52)
⚡ 🔦 🔦 🔦 🔦 🔦	Flash light/ REDEYE REDUC (46)

Upper right

Indicator	Meaning
HDV IN DV IN	HDV input/ DV input (67)
HDV Out DV Out	HDV output/ DV output (34, 65)
i.LINK	i.LINK connection (34, 65, 67, 74)
+0+	Zero set memory (106)
📄 📄 ↺	Slide show (52)
📄 OFF	LCD backlight off (18)

Center

Indicator	Meaning
📷	Color Slow Shutter (47)
📷	PictBridge connecting (71)
📷 ⚠️	Warning (87)
📷	NightShot (27)
📷	Super NightShot (47)

Bottom

Indicator	Meaning
AS	AE SHIFT (45)
WS	WB SHIFT (45)
P+	Picture effect (54)
D+	Digital effect (53)
📷 ⬆️ 👤	Manual focus (45) / SPOT FOCUS (45)/ SPOT MTR-FCS (43)
🌙 👤 🔦 📷	
🌅 📷 👤 📷	SCENE SELECT (42)
📷 👤	
📷	Sharpness (44)
📷	Backlight (27)
📷 ☀️ 📷 📷	White balance (43)
📷	SteadyShot off (48)
📷	Zebra (47)
T📷	Tele macro (46)
📷	CAMERA COLOR (45)
D _W D _F	CONV.LENS (49)
(COLOR)	X.V.COLOR** (49)
📷	SPOT METER (43)/ EXPOSURE (43)/ SPOT MTR-FCS (43)
📷	SHUTTR SPEED (44)
PEAK ING	PEAKING (46)

* The settings can be made only for the pictures in the DV format.

Indicators displayed during recording/playback (Continued)

**The setting can be made only for the pictures in the HDV format.

Other indicator

Indicator	Meaning
	Information (88)

Notes



- Indicators and their positions are approximate and differ from what you actually see.

Checking the screen indicators (Display guide)

You can easily check the meaning of each indicator that appears on the LCD screen.

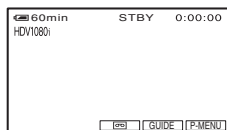
- ① Touch [GUIDE] → [DISP GUIDE].



- ② Touch the area including the indicator that you want to check.
The meanings of the indicators in the area are listed on the screen. If you cannot find the indicator you want to check, touch / to toggle.

To finish the operation, touch [END].

Notes

- Some screen displays cannot be checked with [DISP GUIDE].

Tips

- You can also operate by touching  → [DISP GUIDE].

Index

Numeric

1080i/480i	59
12BIT	57
16BIT	57
480i	59

A

AC Adaptor	13
AE SHIFT	45, 86
ALL ERASE	51
AUDIO MIX	57
AUDIO MODE	57
AUTOSLW SHTR (Auto slow shutter)	45
A.SHUT OFF (Auto shut off)	61
A/V connecting cable	35, 64
A/V OUT jack	34, 104

B

Backlight	27, 82
Battery	13
BEACH	42
BEEP	61

C

CALIBRATION	98
CAM CTRL dial	26
CAMERA COLOR	45
CAMERA DATA	60
CAMERA SET menu	42
CANDLE	42
Cassette	19, 91
CD-ROM	73
CENTER MARKR	60
Charging time	14
Cleaning cassette	97
CLOCK SET	16
CNNCT GUIDE	31, 34
COLOR BAR	60
COLOR SLOW S	

(Color Slow Shutter) 47, 82, 86	
COMPONENT	59
COMPONENT OUT jack	34, 104
Component video cable	35
Computer	73
CONV.LENS	49

D

DATA CODE	16, 60
Date search	33
DATE/TIME	16, 60, 107
Delete pictures	69
DEMO MODE	55
DIAL SET	49
DIGITAL ZOOM	48, 86
DISP GUIDE (Display guide)	110
DISP OUTPUT (Display output)	61
Display indicators	107
Down convert function	10
Dual Rec	25
Dubbing	64
DV format	56
DV SET	57
D.EFFECT (Digital effect)	53, 86

E

Easy Handycam	21, 39
EDIT/PLAY menu	55
END SEARCH	32, 56
EXPOSURE	43, 86

F

FADER	52, 86
FILE NO. (File number)	51
FIREWORKS	42
First Step Guide	73, 77
Flash	81
FLASH LEVEL	46, 82

FLASH SET	46
FLASH (Flash motion)	53
FOCUS	45, 82
FORMAT	51
Frame-by-frame Playback	55

G

Getting Started	12
GUIDEFAME	60

H

HD (high definition) image quality	35
HDMI cable	36
HDMI OUT jack	34, 103
HDV format	56
HDV1080i	10, 57
HDV/DV Interface	34, 104

I

Image protection	70
Image size (IMAGE SIZE)	49
INDOOR	44
“InfoLITHIUM” battery pack	93
Install	75
INT.REC-STL (Interval photo recording)	52
i.LINK	95
i.LINK cable	36, 65, 76
i.LINK CONV	59

L

LANDSCAPE	42
LANGUAGE	62
LCD BL LEVEL (LCD back light level)	58
LCD BRIGHT	58
LCD COLOR	58
LCD/VF SET	58
Lens cover	17, 23
LP (Long Play)	57

Index (Continued)

M

Macintosh	77
Maintenance and precautions	91
MEMORY SET menu	49
“Memory Stick”	92
“Memory Stick Duo”	19
FORMAT	51
Menu	39
MIC LEVEL	58
Mirror mode	27
Moisture condensation	96
MONOTONE	52
MOSAIC FADER	52

N

NEG.ART	54
NEW FOLDER	51
NS LIGHT (NightShot Light)	47
NTSC	83, 90
Number of recordable pictures	50

O

OLD MOVIE	53
ONE PUSH	44
OUTDOOR	44

P

PAL	90
PASTEL	54
PB FOLDER (Playback folder)	51
PB zoom	30
PEAKING	46
Personal Menu	39, 62
Picture Motion Browser	73
PICT.APPLI. menu (Picture Application menu) ..	52
PICT.EFFECT (Picture effect)	54

Playback	28
Playing time	15
P-MENU ... See Personal Menu	
PORTRAIT (Soft portrait) ...	42
Power cord (Mains lead)	13
Print	71
Print mark	70

Q

QUALITY	49
QUICK REC (Quick recording)	61

R

REC CTRL (Recording control)	67
REC FOLDER (Recording folder)	51
REC MODE (Recording mode)	57
Rec review	32
Recording	23
Recording time	14
REDEYE REDUC	47
REMAINING	60
Remaining battery	14, 107
Remote Commander	106
REMOTE CTRL (Remote control)	60
Reversal Playback	55

S

S VIDEO jack	34, 36, 64
SCENE SELECT	42, 85
SD (standard definition) image quality	36
Searching for the starting point	32
SELF-TIMER	48
SEPIA	54
SHARPNESS	44, 86
SHUTTR SPEED	44
SKINTONE	54

SLIDE SHOW	52
SMTH SLW REC (Smooth slow recording)	54, 86
SNOW	42
SOLARIZE	54
SP (Standard Play)	57
Specifications	99
SPOT FOCUS	45, 86
SPOT METER (Flexible spot meter)	43, 86
SPOT MTR-FCS	43
SPOTLIGHT	42
STANDARD	49
STANDARD SET menu	56
STATUS CHECK	59
STEADYSHOT	48, 82
STILL	53
Still image	24, 29, 49, 92
STILL SET	49
SUNRSE SUNSET (Sunrise and sunset)	42
SUPER NS (Super NightShot)	47

T

Tape counter	107
TELE MACRO	46, 86
Time code	107
TIME/LANGU. menu	62
TRAIL	53
Tripod	105
TV	34
TV color systems	90
TV TYPE	59

U

USAGE GUIDE	31
USB jack	104
USB SELECT	55
Using abroad	90

V

VAR.SPD PB (Various speed playback)	55
VF B.LIGHT (Viewfinder brightness)	58
VOLUME	58

W

Warning indicators	87
Warning messages	88
WB SHIFT (White Balance Shift)	45
WHITE BAL. (White balance)	43, 86
WHITE FADER	52
Windows	73, 74
WORLD TIME	62
Write-protect tab	91

X

X.V.COLOR	49, 96
-----------------	--------

Z

ZEBRA	47
Zero set memory	32
Zoom	25

Paso 1: Comprobación de los elementos suministrados

Asegúrese de que su videocámara contiene los siguientes elementos.

El número entre paréntesis indica la cantidad del elemento.

Adaptador de alimentación de ca (1)

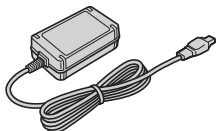

Cable de alimentación (1)



Control remoto inalámbrico (1)



Tiene instalada una pila de litio tipo botón.

Cable de conexión de A/V (1)



Cable de video componente (1)

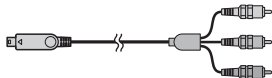

Cable i.LINK (1)



Cable USB (1)

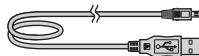

Batería recargable NP-FH60 (1)

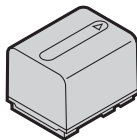

Protector del objetivo (1)



Extraiga el protector del objetivo si utiliza el flash, Nightshot o SuperNightshot, o cuando aparece su sombra en la imagen.

CD-ROM "Handycam Application Software" (1)

Guía de operaciones (este manual) (1)

Paso 2: Carga de la batería

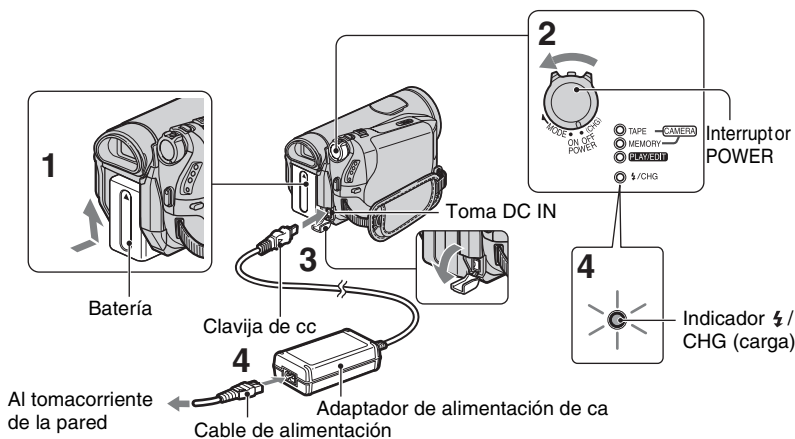

Para cargar la batería "InfoLITHIUM" (serie H), conéctela a la videocámara.

⚡ Notas

- No puede conectar ninguna batería "InfoLITHIUM" que no sea de la serie H a la videocámara.

1 Instale la batería en la videocámara.

Deslice la batería en el sentido de la flecha hasta que calce para colocarla.

2 Deslice el interruptor POWER hasta la posición OFF (CHG) (el ajuste predeterminado).

3 Conecte el adaptador de alimentación de ca a la toma DC IN de la videocámara. Asegúrese de que la marca ▲ de la clavija de cc esté orientada hacia a la marca ▲ de la videocámara.

4 Conecte el cable de alimentación al adaptador de alimentación de ca y al tomacorriente de pared.

El indicador ⚡ / CHG (carga) se enciende y se inicia el proceso de carga. El indicador ⚡ / CHG (carga) se apaga cuando la batería está completamente cargada.

⚡ Notas

- Desconecte el adaptador de alimentación de ca de la toma DC IN sujetando a la vez la videocámara y la clavija de cc.

💡 Sugerencias

- Puede utilizar su videocámara conectada a una fuente de alimentación como un tomacorriente de pared tal como se muestra en la ilustración. La batería no perderá la carga en este caso.

Para retirar la batería

Deslice el interruptor POWER hasta la posición OFF (CHG). Deslice la palanca BATT (liberación de la batería) y retire la batería.

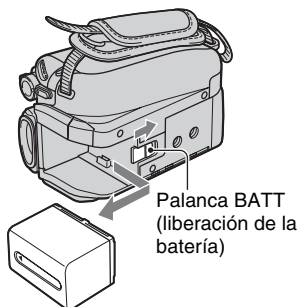

Cuando guarde la batería

Descargue completamente la batería antes de guardarla durante un período prolongado.

Para comprobar la carga restante de la batería (Información sobre la batería)

Ajuste el interruptor POWER en OFF(CHG) y, a continuación, presione DISPLAY/BATT INFO.

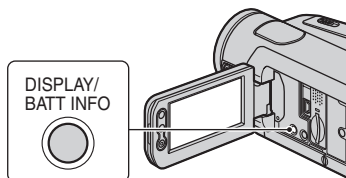

Después de cierto tiempo, el tiempo disponible para grabación y la información sobre la batería aparecen durante aproximadamente 7 s (segundo). Puede ver la información sobre la batería durante 20 s (segundo) presionando nuevamente DISPLAY/BATT INFO mientras se visualiza la información.

Carga restante de la batería (aprox.)

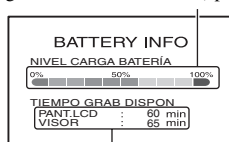

Capacidad de grabación (aprox.)

Puede comprobar la carga restante de la batería en la pantalla LCD.

Indicador	Estado
	Suficiente energía restante
	Batería baja, la grabación/reproducción se detendrá pronto.
	Sustituya la batería por una completamente cargada, o cargue la batería.

Tiempo de carga

Tiempo aproximado (min) necesario para cargar totalmente una batería descargada por completo.

Batería	Tiempo de carga
NP-FH50	135
NP-FH60 (suministrada)	135
NP-FH70	170
NP-FH100	390

Paso 2: Carga de la batería (Continuación)

Tiempo de grabación

Tiempo aproximado (min) disponible cuando utiliza una batería completamente cargada.

Batería	Tiempo de grabación continua		Tiempo de grabación normal*	
	HDV	DV	HDV	DV
Formato de grabación				
NP-FH50	70	70	40	40
	70	75	40	40
	75	80	40	45
NP-FH60 (suministrada)	90	95	50	50
	95	100	50	55
	100	105	55	55
NP-FH70	150	155	80	85
	155	165	85	90
	160	170	85	90
NP-FH100	345	365	185	195
	365	385	195	210
	375	395	205	215

* El tiempo de grabación normal muestra la hora cuando se repite la operación de inicio/detención de la grabación, al conectar y desconectar la alimentación y al usar la función de zoom.

Notas

- Todo los tiempos se calcularon en las siguientes condiciones:
Superior: Con la luz de fondo de la pantalla LCD encendida.
Medio: Con la luz de fondo de la pantalla LCD apagada.
Inferior: Grabación con el visor mientras el panel LCD se encuentra cerrado.

Tiempo de reproducción

Tiempo aproximado (min) disponible cuando utiliza una batería completamente cargada.

Batería	Panel LCD abierto*		Panel LCD cerrado	
	HDV	DV	HDV	DV
Formato grabado				
NP-FH50	105	115	120	130
NP-FH60 (suministrada)	140	150	160	170
NP-FH70	230	245	255	280
NP-FH100	525	565	590	635

* Con la luz de fondo de la pantalla LCD encendida.

Acerca de la batería

- Antes de cambiar la batería, deslice el interruptor POWER a la posición OFF (CHG).
- El indicador  /CHG (carga) parpadeará durante la carga o la información de la batería no se mostrará correctamente en las siguientes condiciones.
 - La batería no está correctamente conectada.
 - La batería está dañada.
 - La batería está agotada (sólo para la información de la batería).
- Cuando el adaptador de alimentación de ca esté conectado a la toma DC IN de la videocámara, la batería no suministrará alimentación, aunque el cable de alimentación esté desconectado del tomacorriente de pared.
- Si instala una luz de video opcional, es recomendable que utilice los modelos de batería NP-FH70 o NP-FH100.

Acerca del tiempo de carga/grabación/reproducción

- Tiempos medidos con la videocámara a una temperatura de 25 °C (se recomienda una temperatura de 10 a 30 °C).
- El tiempo de grabación y de reproducción será más corto cuando use la videocámara a bajas temperaturas.
- El tiempo de grabación y de reproducción será más corto en función de las condiciones de uso de la videocámara.

Paso 3: Encendido y ajuste de la fecha y la hora

Acerca del adaptador de alimentación de ca

- Si utiliza el adaptador de alimentación de ca conéctelo a un tomacorriente de pared cercano. Si se produce alguna falla de funcionamiento al utilizar la videocámara, desconecte el adaptador de alimentación de ca del tomacorriente de inmediato.
- No utilice el adaptador de alimentación de ca colocado en un espacio angosto, tal como entre una pared y los muebles.
- Evite la formación de cortocircuitos en la clavija de cc del adaptador de alimentación de ca o en el terminal de la batería con objetos metálicos. Podría provocar una falla de funcionamiento.
- Aunque la videocámara esté apagada, seguirá recibiendo adaptador de alimentación de ca (corriente doméstica) mientras esté conectada a la toma de pared mediante el adaptador de alimentación de ca

Ajuste la fecha y la hora cuando use la videocámara por primera vez. De lo contrario, la pantalla [AJUS.RELOJ] aparecerá cada vez que encienda la videocámara o cambie la posición del interruptor POWER.

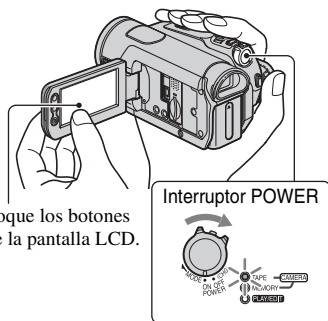

Toque los botones de la pantalla LCD.

- 1 Mientras presiona el botón verde, deslice el interruptor POWER en el sentido de la flecha para que se encienda el indicador correspondiente.

CAMERA-TAPE: para grabar en una cinta.

CAMERA-MEMORY: para grabar en un "Memory Stick Duo".

PLAY/EDIT: para reproducir o editar imágenes.

Aparecerá la pantalla [AJUS.RELOJ].



Paso 3: Encendido y ajuste de la fecha y la hora (Continuación)

2 Ajuste [A] (año) con /.

Puede seleccionar cualquier año hasta el año 2079.

3 Vaya hasta [M] (mes) con , y ajústelo con /.

4 Vaya hasta [D] (día) con , ajústelo con / y repita la operación para ajustar las horas y los minutos.

Ajuste la medianoche a las 12:00 AM.
Ajuste el mediodía a las 12:00 PM.



5 Asegúrese de que los ajustes de fecha y hora son correctos y, a continuación, toque .

El reloj se pone en funcionamiento.

Para apagar la videocámara

Deslice el interruptor POWER hasta la posición OFF (CHG).

Para restablecer la fecha y la hora

Para ajustar la fecha y la hora deseadas, toque  → / → [AJUS.RELOJ].

Notas



- Si no usa la videocámara durante **aproximadamente 3 meses**, la batería recargable incorporada se descarga y es posible que los ajustes de la fecha y la hora se borren de la memoria. En este caso, cargue la batería recargable y ajuste la fecha y la hora nuevamente.
- Al momento de la compra, la alimentación se ajusta para desconectarse automáticamente si no se opera la videocámara durante unos 5 min (minuto) para ahorrar energía de la batería ([APAGADO AUTO]).

Sugerencias

- La fecha y hora no aparecen durante la grabación, pero se graban automáticamente en la cinta y pueden visualizarse durante la reproducción ([CÓDIGO DATOS] (durante el funcionamiento de Easy Handycam, sólo puede ajustar [FECHA/HORA])).
- La tapa del objetivo se abre automáticamente al ajustar el interruptor POWER en CAMERA-TAPE o CAMERA-MEMORY.
- Si los botones del panel sensible al tacto no funcionan correctamente, ajuste el panel sensible al tacto (CALIBRACIÓN).

Cambio del ajuste de idioma

Puede cambiar las indicaciones en pantalla para que muestren mensajes en un idioma en particular.

Toque  → [MENU] → 
(HORA/LANGU.) → [LANGUAGE], y luego seleccione el idioma deseado.

Paso 4: Ajustes antes de grabar

Panel LCD

Abra el panel LCD 90 grados con respecto a la videocámara (1) y luego gírelo hacia el mejor ángulo para grabar o reproducir (2).

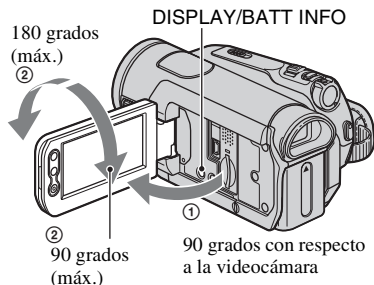

Para desactivar la luz de fondo de la pantalla LCD y prolongar la duración de la batería

Mantenga presionado DISPLAY/BATT INFO durante unos s (segundo) hasta que aparezca .

Este ajuste es práctico cuando utiliza la videocámara en lugares muy luminosos o cuando desea ahorrar energía. Este ajuste no afectará a la imagen grabada. Para encender la luz de fondo de la pantalla LCD, mantenga presionado DISPLAY/BATT INFO durante unos s (segundo) hasta que desaparezca.

Notas

- No presione los botones del panel LCD por error al abrirlo o ajustarlo.

Sugerencias

- Si gira el panel LCD 180 grados hacia el lado del objetivo, podrá cerrarlo con la pantalla LCD hacia afuera. Esto resulta conveniente para las operaciones de reproducción.
- Consulte [AJ LCD/VISOR] - [BRILLO LCD] para ajustar el brillo de la pantalla LCD.
- Presione DISPLAY/BATT INFO para activar o desactivar los indicadores de pantalla (como la información sobre la batería).

Visor

Puede ver imágenes utilizando el visor para evitar el desgaste de la batería o cuando la imagen en la pantalla LCD sea deficiente.

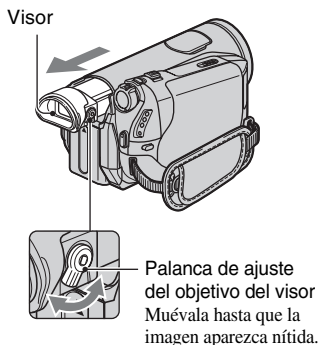

Sugerencias

- Puede ajustar el brillo de fondo del visor seleccionando [AJ LCD/VISOR] - [LUZ F.VISOR].

Correa de sujeción

Ajuste la correa de sujeción y sostenga la cámara correctamente.

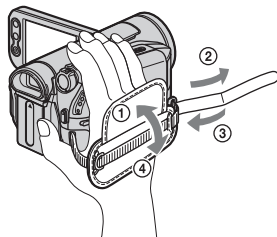

Paso 5: Inserción de una cinta o un “Memory Stick Duo”

Cinta de videocasete

Solamente puede utilizar videocasetes mini DV ^{Mini} DV.

Notas

- El tiempo disponible para grabación varía en función del [MODO GRAB.]. DV

- 1 Deslice y sostenga la palanca **OPEN/EJECT** en el sentido de la flecha y abra la tapa.

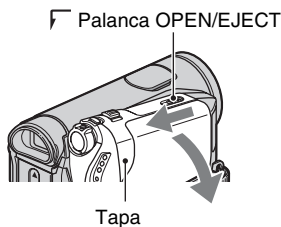

El compartimiento del videocasete sale automáticamente y se abre.

- 2 Inserte un videocasete con la cara de la ventanilla hacia afuera y, a continuación, presione **PUSH**.

Presione ligeramente el centro de la parte posterior del videocasete.

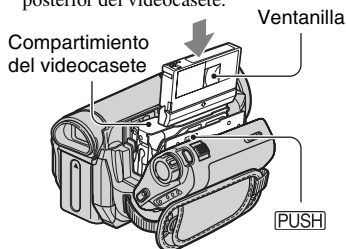

El compartimiento del videocasete se desliza automáticamente hacia adentro.

- 3 Cierre la tapa.

Para expulsar el videocasete

Abra la tapa realizando el mismo procedimiento que se describe en el paso 1 y extraiga el videocasete.

Notas

- No fuerce el compartimiento del videocasete presionando la parte con la marca **DO NOT PUSH** mientras se desliza hacia adentro. Podría provocar una falla de funcionamiento.

“Memory Stick Duo”

Puede utilizar “Memory Stick” que presenten el logotipo que aparece a continuación.

- MEMORY STICK DUO (“Memory Stick Duo”)
- MEMORY STICK PRO DUO (“Memory Stick PRO Duo”)
- MEMORY STICK PRO-HG DUO (“Memory Stick PRO-HG Duo”)

Sugerencias

- El número y la duración de las imágenes que se pueden grabar varía en función de la calidad o del tamaño de la imagen.

- 1 Abra el panel LCD.

- 2 Inserte el “Memory Stick Duo” en la ranura para Memory Stick Duo en el sentido correcto hasta que calce.

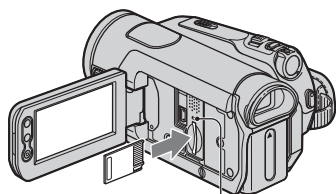

Indicador de acceso

Para expulsar un “Memory Stick Duo”

Empuje suavemente el “Memory Stick Duo” hacia dentro una vez.

🔊 Notas

- Cuando el indicador de acceso se enciende o parpadea, la videocámara está leyendo o grabando datos. No sacuda ni golpee la videocámara, no la apague, ni extraiga el “Memory Stick Duo” ni retire la batería. De lo contrario, se podrían dañar los datos de imágenes.
- Si fuerza el “Memory Stick Duo” en la ranura en la dirección incorrecta, puede dañarse el “Memory Stick Duo”, la ranura para el Memory Stick Duo o los datos de imágenes.
- Al insertar o expulsar el “Memory Stick Duo”, procure que el “Memory Stick Duo” no salte y se caiga.

Grabación

Cubierta del objetivo
Se abre según el ajuste del
interruptor POWER.

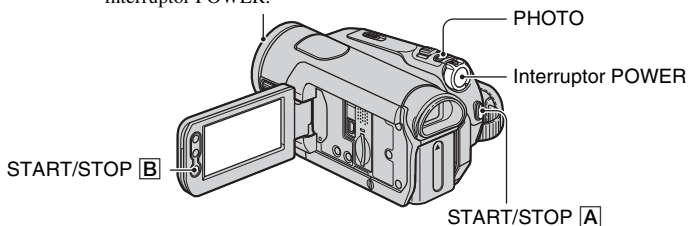

Grabación de películas



Las películas se graban en una cinta.

- 1 Deslice el interruptor POWER varias veces en el sentido de la flecha para que se encienda el indicador CAMERA-TAPE.

Si el interruptor POWER está ajustado en la posición OFF (CHG), deslícelo mientras presiona el botón verde.

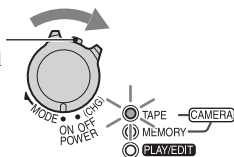

- 2 Presione START/STOP [A] (o [B]).

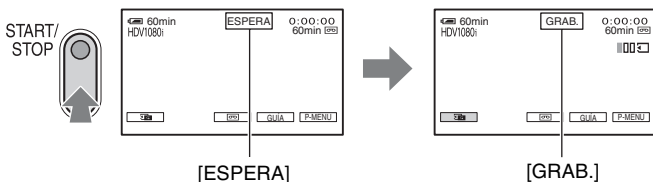

Para detener la grabación, presione START/STOP [A] (o [B]) nuevamente.

Sugerencias

- Las imágenes se graban en formato HDV con el ajuste predeterminado.

Grabación de imágenes fijas



Las imágenes fijas se graban en el "Memory Stick Duo".

- 1** Deslice el interruptor **POWER** varias veces en el sentido de la flecha para que se encienda el indicador **CAMERA-MEMORY**.

Si el interruptor **POWER** está ajustado en la posición **OFF (CHG)**, deslícelo mientras presiona el botón verde.

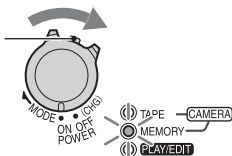

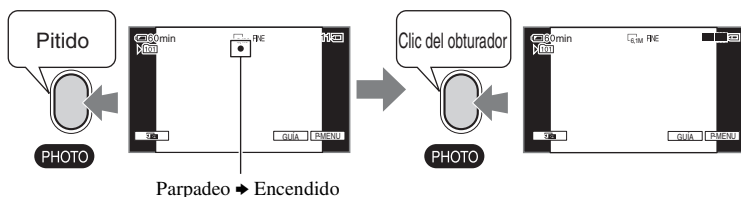

- 2** Mantenga presionado ligeramente **PHOTO** para ajustar el enfoque y luego presiónelo completamente para grabar.



Se escucha el sonido del obturador. Cuando  desaparezca, la imagen se habrá grabado.

Para verificar la última grabación en un "Memory Stick Duo"

Toque . Para borrar la imagen, toque  → [SÍ].

Reproducción

Deslice el interruptor POWER en el sentido de la flecha varias veces para encender el indicador PLAY/EDIT.

Si el interruptor POWER está ajustado en la posición OFF (CHG), deslícelo mientras presiona el botón verde.

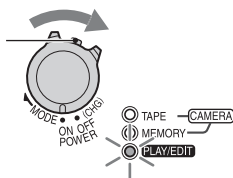

Reproducción de películas



Toque para rebobinar hasta la escena deseada y luego toque para iniciar la reproducción.

Alterna entre Reproducir o Pausa cada vez que lo toca*

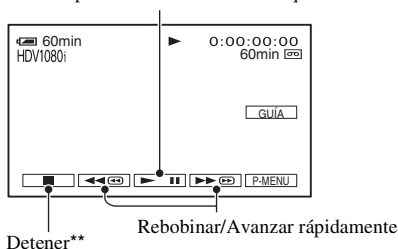

* La reproducción se detiene automáticamente si la pausa permanece accionada durante más de 3 min (minuto).

** Se visualiza MEMORY en lugar de cuando se inserta un "Memory Stick Duo" con imágenes grabadas y no se está reproduciendo una cinta.

Para ajustar el volumen del sonido

Gire el selector CAM CTRL para ajustar el volumen manualmente.

Sugerencias

- También puede ajustar el volumen desde el menú.

Para buscar una escena durante la reproducción

Mantenga presionado / durante la reproducción (Búsqueda de imágenes), o / durante el avance rápido o rebobinado de la cinta (Exploración con salto).

Sugerencias

- Puede reproducir en diversos modos ([] REP VL VAR).



Toque **MEMORY**.

Se visualiza la imagen grabada más recientemente.

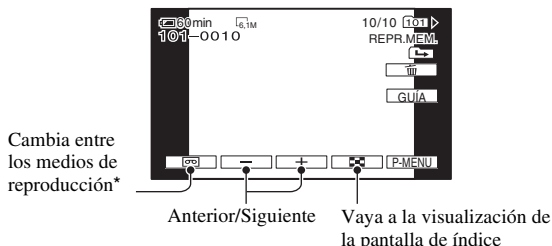

* **MEMORY** aparece en la pantalla de reproducción de cintas.

Para visualizar imágenes de un “Memory Stick Duo” en la pantalla de índice

Toque **INDEX**. Toque una de las imágenes para regresar al modo de presentación sencilla.

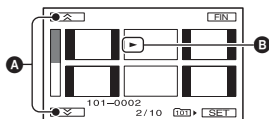

A 6 imágenes anteriores o siguientes

B Imagen mostrada antes de cambiar a la pantalla de índice

Para ver imágenes de otras carpetas, toque **INDEX** → **SET** → [REPR. CARP.], seleccione una carpeta con **DOWN**/**UP** y luego toque **OK**.

Additional information on this product and answers to frequently asked questions can be found at our Customer Support Website.

<http://www.sony.net/>



Printed on 70% or more recycled paper using VOC (Volatile Organic Compound)-free vegetable oil based ink.

Printed in Japan



3278987120