

TOSHIBA



19/22-inch* Diagonal LCD TV/DVD COMBINATION

19LV505
19LV506
22LV505

OWNER'S MANUAL



Illustration of 19LV505

©2008 Toshiba Corporation
Before operating the unit, please read this manual thoroughly.
*Screen size is approximate.

Introduction	4
Connections	14
Basic setup	21
TV operation	26
Basic playback	44
Advanced playback	47
Function setup	60
Others	66

Owner's Record

The model number and serial number are on the back of your TV/DVD. Record these numbers in the spaces below. Refer to these numbers whenever you communicate with your Toshiba dealer about this TV/DVD.

Model number: _____
Serial number: _____

Dear Customer,

Thank you for purchasing this Toshiba LCD TV or TV/DVD Combination television.

This manual will help you use the many exciting features of your new LCD TV. Before operating your LCD TV or TV/DVD Combination, please read this manual completely, and keep it nearby for future reference.

Safety Precautions

WARNING: TO REDUCE THE RISK OF FIRE OR ELECTRIC SHOCK, DO NOT EXPOSE THIS APPLIANCE TO RAIN OR MOISTURE.



WARNING
RISK OF ELECTRIC SHOCK
DO NOT OPEN



CAUTION: TO REDUCE THE RISK OF ELECTRIC SHOCK, DO NOT REMOVE COVER (OR BACK).

NO USER-SERVICEABLE PARTS INSIDE. REFER SERVICING TO QUALIFIED SERVICE PERSONNEL.



The lightning flash with arrowhead symbol, within an equilateral triangle, is intended to alert the user to the presence of uninsulated "dangerous voltage" within the product's enclosure that may be of sufficient magnitude to constitute a risk of electric shock to persons.



The exclamation point within an equilateral triangle, is intended to alert the user to the presence of important operating and maintenance (servicing) instructions in the literature accompanying the appliance.

CAUTION: To reduce the risk of electric shock, do not use the polarized plug with an extension cord, receptacle, or other outlet unless the blades can be inserted completely to prevent blade exposure.

WARNING: If you decide to wall mount this television, always use a UL Listed wall bracket appropriate for the size and weight of this television. The use of any wall bracket other than a UL Listed wall bracket appropriate for the size and weight of this television for wall mounting this television could result in serious bodily injury and/or property damage.



ENERGY STAR® qualified TV. Products that earn the ENERGY STAR prevent green house gas emissions by meeting strict energy efficiency guidelines set by the U.S. Environmental Protection Agency and the U.S. Department of Energy. ENERGY STAR and the ENERGY STAR mark are registered U.S. marks.

NOTE TO CATV INSTALLERS

This is a reminder to call the CATV system installer's attention to Article 820-40 of the NEC, which provides guidelines for proper grounding and, in particular, specifies that the cable ground shall be connected to grounding system of the building, as close to the point of cable entry as practical. For additional antenna grounding information, see item 27 on page 5.

Child Safety

It Makes A Difference Where Your TV Stands

Congratulations on your purchase!

As you enjoy your new TV, keep these safety tips in mind:



The Issue

- If you are like most consumers, you have a TV in your home. Many homes, in fact, have more than one TV.
- The home theater entertainment experience is a growing trend, and larger TVs are popular purchases; however, they are not always supported on the proper TV stands.
 - Sometimes TVs are improperly secured or inappropriately situated on dressers, bookcases, shelves, desks, audio speakers, chests, or carts. As a result, TVs may fall over, causing unnecessary injury.



Toshiba Cares!

- The consumer electronics industry is committed to making home entertainment enjoyable and safe.
- The Consumer Electronics Association formed the Home Entertainment Support Safety Committee, comprised of TV and consumer electronics furniture manufacturers, to advocate children's safety and educate consumers and their families about television safety.

Tune Into Safety

- One size does NOT fit all! Use appropriate furniture large enough to support the weight of your TV (and other electronic components).
- Use appropriate angle braces, straps, and anchors to secure your furniture to the wall (but never screw anything directly into the TV).
- Carefully read and understand the other enclosed instructions for proper use of this product.
- Do not allow children to climb on or play with furniture and TVs.
- Avoid placing any item on top of your TV (such as a VCR, remote control, or toy) that a curious child may reach for.
- Remember that children can become excited while watching a program and can potentially push or pull a TV over.
- Share our safety message about this hidden hazard of the home with your family and friends. Thank you!



2500 Wilson Blvd.
Arlington, VA 22201 U.S.A.
www.CE.org

CEA is the Sponsor, Producer and Manager of the International CES®

FCC compliance information

CAUTION: TO PREVENT ELECTRIC SHOCK DO NOT USE THIS POLARIZED PLUG WITH AN EXTENSION CORD, RECEPTACLE OR OTHER OUTLET UNLESS THE BLADES CAN BE FULLY INSERTED TO PREVENT BLADE EXPOSURE.

FCC Declaration of Conformity Compliance Statement (Part 15):

The Toshiba 19LV505, 19LV506, 22LV505, LCD TV/DVD Combination complies with Part 15 of the FCC rules. Operation is subject to the following two conditions: (1) this device may not cause harmful interference, and (2) this device must accept any interference received, including interference that may cause undesired operation.

The party responsible for compliance to these rules is:

Toshiba America Consumer Products, L.L.C.

82 Totowa Rd. Wayne, NJ 07470.

Ph: (800) 631-3811 or visit TACP's website at www.tacp.Toshiba.com

NOTE: This equipment has been tested and found to comply with the limits for a Class B digital device, pursuant to Part 15 of the FCC rules. These limits are designed to provide reasonable protection against harmful interference in a residential installation. This equipment generates, uses, and can radiate radio frequency energy and, if not installed and used in accordance with the instructions, may cause harmful interference to radio communications. However, there is no guarantee that interference will not occur in a particular installation. If this equipment does cause harmful interference to radio or television reception, which can be determined by removing and applying power to the equipment, the user is encouraged to try to correct the interference by one or more of the following measures:

- Reorient or relocate the receiving antenna.
- Increase the separation between the equipment and the receiver.
- Connect the equipment into an outlet on a circuit different from that to which the receiver is connected.
- Consult the dealer or an experienced radio/TV technician for help.

CAUTION: Changes or modifications to this equipment not expressly approved by Toshiba could void the user's authority to operate this equipment.

CAUTION:

THIS DIGITAL VIDEO PLAYER EMPLOYS A LASER SYSTEM.

TO ENSURE PROPER USE OF THIS PRODUCT, PLEASE READ THIS OWNER'S MANUAL CAREFULLY AND RETAIN FOR FUTURE REFERENCE. SHOULD THE UNIT REQUIRE MAINTENANCE, CONTACT AN AUTHORIZED SERVICE LOCATION.

USE OF CONTROLS, ADJUSTMENTS OR THE PERFORMANCE OF PROCEDURES OTHER THAN THOSE SPECIFIED HEREIN MAY RESULT IN HAZARDOUS RADIATION EXPOSURE.

TO PREVENT DIRECT EXPOSURE TO LASER BEAM, NEVER OPEN THE ENCLOSURE. VISIBLE LASER RADIATION MAY BE PRESENT WHEN THE ENCLOSURE IS OPENED. NEVER STARE INTO BEAM.

Location of the required Marking

The rating sheet and the safety caution are the rear of the unit.

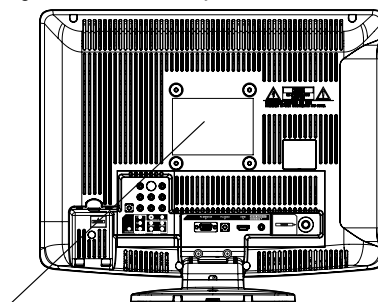

Illustration of 19LV505

CERTIFICATION: COMPLIES WITH FDA RADIATION PERFORMANCE STANDARDS, 21 CFR SUBCHAPTER J.

ON DISPOSAL

The lamp(s) inside this product contain mercury. Disposal may be regulated due to environmental considerations. For disposal or recycling information, contact your local authorities or the Electronic Industries Alliance (www.eiae.org).

SAFETY INSTRUCTIONS

Important Safety Instructions

- 1) **Read these instructions.**
- 2) **Keep these instructions.**
- 3) **Heed all warnings.**
- 4) **Follow all instructions.**



- 5) **Do not use this apparatus near water.**
- 6) **Clean only with dry cloth.**
- 7) **Do not block any ventilation openings.**
Install in accordance with the manufacturer's instructions.

- 8) **Do not install near any heat sources** such as radiators, heat registers, stoves, or other apparatus (including amplifiers) that produce heat.

- 9) **Do not defeat the safety purpose of the polarized or grounding type plug.** A polarized plug has two blades with one wider than the other. A grounding type plug has two blades and a third grounding prong. The wide blade or the third prong are provided for your safety. If the provided plug does not fit into your outlet, consult an electrician for replacement of the obsolete outlet.

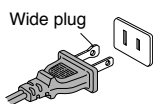

- 10) **Protect the power cord** from being walked on or pinched, particularly at plugs, convenience receptacles, and the point where they exit from the apparatus.

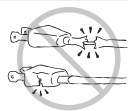

- 11) **Only use attachments/accessories specified by the manufacturer.**

- 12) **Use only with the cart, stand, tripod, bracket, or table specified by the manufacturer, or sold with the apparatus.** When a cart is used, use caution when moving the cart/apparatus combination to avoid injury from tip-over.



- 13) **Unplug this apparatus during lightning storms or when unused for long periods of time.**



- 14) **Refer all servicing to qualified service personnel.** Servicing is required when the apparatus has been damaged in any way, such as power-supply cord or plug is damaged, liquid has been spilled or objects have fallen into the apparatus, the apparatus has been exposed to rain or moisture, does not operate normally, or has been dropped.

Additional Safety Precautions

- 14a) **CAUTION:** If the TV is dropped and the cabinet or enclosure surface has been damaged or the TV does not operate normally, take the following precautions:
 - ALWAYS turn off the TV and unplug the power cord to avoid possible electric shock or fire.
 - NEVER allow your body to come in contact with any broken glass or liquid from the damaged television. The LCD panel inside the TV contains glass and a toxic liquid. If the liquid comes in contact with your mouth or eyes, or your skin is cut by broken glass, rinse the affected area thoroughly with water and consult your doctor.
- 15) To avoid damage to this product, never place or store the TV in direct sunlight; hot, humid areas; or areas subject to excessive dust or vibration.

Installation, Care, and Service

Installation

Follow these recommendations and precautions and heed all warnings when installing your TV:

- 16) Never modify this equipment. Changes or modifications may void: a) the warranty, and b) the user's authority to operate this equipment under the rules of the Federal Communications Commission.

- 17) **DANGER: RISK OF SERIOUS PERSONAL INJURY, DEATH, OR EQUIPMENT DAMAGE!** Never place the TV on an unstable cart, stand, or table. The TV may fall, causing serious personal injury, death, or serious damage to the TV.



- 18) Never place items such as vases, aquariums, or candles on top of the TV.

- 19) **WARNING:** To prevent injury, this apparatus must be securely attached to the floor/wall in accordance with the installation instructions. Always place the TV on the floor or a sturdy, level, stable surface that can support the weight of the unit. Use a sturdy tie between the TV's rear hook and the rear wall, pillar, etc., to secure the TV. If you use a TV stand, fasten the TV to the stand using the attached band (under the TV pedestal).

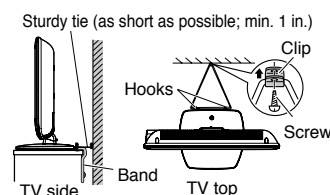

- 20) Never expose the apparatus to dripping or splashing liquid or place items such as vases, aquariums, any other item filled with liquid, or candles on top of the TV.

- 21) Never block or cover the slots or openings in the TV cabinet back, bottom, and sides. Never place the TV:
 - on a bed, sofa, rug, or similar surface;
 - too close to drapes, curtains, or walls; or
 - in a confined space such as a bookcase, built-in cabinet, or any other place with poor ventilation.

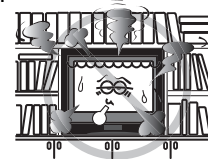

The slots and openings are provided to protect the TV from overheating and to help maintain reliable operation of the TV. Leave a space of at least 4 inches around the TV.

- 22) Always place the back of the television at least one (1) inch away from any vertical surface (such as a wall) to allow proper ventilation.
- 23) Never allow anything to rest on or roll over the power cord, and never place the TV where the power cord is subject to wear or abuse.
- 24) Never overload wall outlets and extension cords.
- 25) Always operate the TV with a 120V AC, 60Hz power source only.



CAUTION: To reduce the risk of electric shock, do not use the polarized plug with an extension cord, receptacle, or other outlet unless the blades can be inserted completely with three-wire grounding type to prevent blade exposure.

SAFETY INSTRUCTIONS (Continued)

Installation (cont. from previous page)

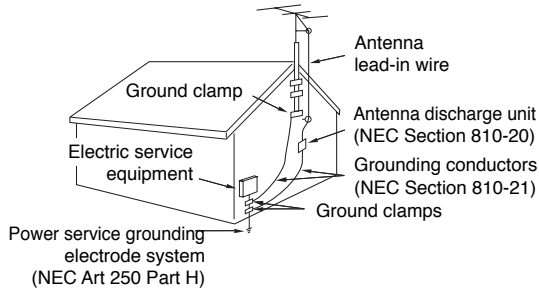

- 26) Always make sure the antenna system is properly grounded to provide adequate protection against voltage surges and built-up static charges (see Section 810 of the National Electric Code.)



- 27)  **DANGER: RISK OF SERIOUS PERSONAL INJURY OR DEATH!**
- Use extreme care to make sure you are never in a position where your body (or any item you are in contact with, such as a ladder or screwdriver) can accidentally touch overhead power lines. Never locate the antenna near overhead power lines or other electrical circuits.
 - Never attempt to install any of the following during lightning activity: a) an antenna system; or b) cables, wires, or any home theater component connected to an antenna or phone system.
- 

Care

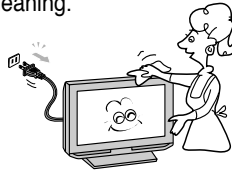
For better performance and safer operation of your TOSHIBA TV, follow these recommendations and precautions:

- 28) Always unplug the TV before cleaning. Wipe the display panel surface gently using only a soft cloth (supplied.) A hard cloth may damage the surface of the panel. Avoid contact with alcohol, thinner, benzene, acidic or and alkaline solvent cleaners, abrasive cleaners, or chemical cloths, as the surface may be impaired.
- 
- 29)  **WARNING: RISK OF ELECTRIC SHOCK!** Never spill liquids or push objects of any kind into the TV cabinet slots.
- 30) While it is thundering, do not touch the connecting cables or apparatus.
- 31) For added protection of your TV from lightning and power surges, always unplug the power cord and disconnect the antenna from the TV if you leave the TV unattended or unused for long periods of time.
- 32) During normal use, the TV may make occasional snapping or popping sounds. This is normal, especially when the unit is being turned on or off. If these sounds become frequent or continuous, unplug the power cord and contact a Toshiba Authorized Service Center.

Care (cont. from previous column)

- 33) Keep your fingers well clear of the disc slot as it is closing. Failure to do so may cause serious personal injury.
- 34) When you use headphones, keep the volume at a moderate level. Using headphones continuously at a high volume may cause hearing damage.
- 35) NEVER look directly into the disc slot or ventilation slots at the source of the laser beam. Doing so may cause sight damage.
- 36) NEVER use a cracked, deformed, or repaired disc. Such discs are easily broken and may cause serious personal injury or product damage. SUCH DAMAGE IS NOT COVERED UNDER YOUR WARRANTY.
- 37) **WARNING: RISK OF SERIOUS PERSONAL INJURY OR EQUIPMENT DAMAGE!**
- Never strike the screen with a sharp or heavy object.
 - Never touch, press, or place anything on the LCD screen. These actions will damage the LCD screen. If you need to clean the LCD screen, follow the instructions in item 28 on this page.

Service

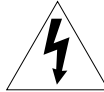
- 38)  **WARNING: RISK OF ELECTRIC SHOCK!** Never attempt to service the TV yourself. Opening and removing the covers may expose you to dangerous voltage or other hazards. Refer all servicing to a Toshiba Authorized Service Center.
- 39) If you have the TV serviced:
- Ask the service technician to use only replacement parts specified by the manufacturer.
 - Upon completion of service, ask the service technician to perform routine safety checks to determine that the TV is in safe operating condition.
- 40) When the TV reaches the end of its useful life, ask a qualified service technician to properly dispose of the TV.

Precautions

Choosing a location for your LCD TV

■ Retractable pedestal stand and locating the LCD TV

Observe the following safety precautions:

- 1) Ensure that unpacking and transfer of the unit is carried out by two or more people.
- 2) Put the LCD TV on a large level area in a recumbent posture.
- 3) Grab the pedestal stand and lift the display up. Confirm the pivot is locked.
- 4) Place the TV on a sturdy, level surface that can support the weight of the TV.
- 5) Be sure to secure the TV to a wall, pillar, surface, or other immovable structure. To secure the TV in this manner, use the included strap located at the rear of pedestal stand. (see item 19, page 4).

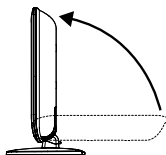

■ To fold the pedestal stand

- 1) Slide the lever on the back side of the pedestal stand to the left.
- 2) Lay the display down.

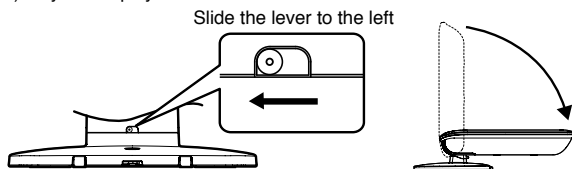

Back side of the pedestal stand

NOTE: Do not operate the LCD TV while the pedestal stand is folded.

■ To Display your LCD TV using a Wall Bracket:

If you decide to wall mount your LCD TV, always use a UL Listed wall bracket appropriate for the size and weight of the LCD TV (see page 2):

- 1) **CAUTION:** Two people are required for installation.
- 2) Unplug and remove any cables and/or other component connectors from the rear of the TV.
- 3) **Follow the instructions** provided with your wall bracket. Before proceeding, make sure the appropriate bracket(s) are attached to the wall and the back of the TV as described in the instructions provided with the wall bracket.
- 4) After attaching the appropriate bracket(s) to the wall and the back of the TV, remove the pedestal stand from the TV as described below.

■ Removing the Pedestal Stand

- 1) Carefully lay the front of the unit face down on a flat, cushioned surface such as a quilt or blanket. Leave the stand protruding over the edge of the surface.

NOTE: Extreme care should always be used when removing the pedestal stand to avoid damage to the LCD panel.

- 2) Remove the two screws shown in the diagram below. This will allow removal of the pedestal stand.
- 3) Once you have removed all two screws holding the pedestal stand in place, remove the pedestal stand from the TV by sliding the pedestal stand away from the TV.

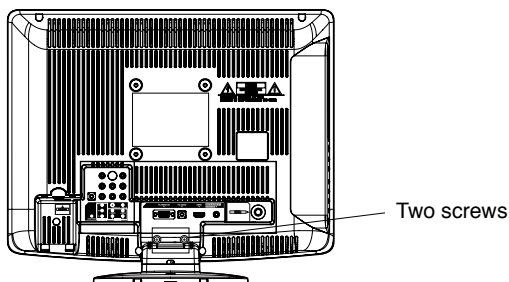

Important notes about your LCD TV

The following symptoms are technical limitations of LCD Display technology and are not an indication of malfunction; therefore, Toshiba is not responsible for perceived defects resulting from these symptoms.

- 1) An after image (ghost) may appear on the screen if a fixed, non-moving image is displayed for a long period of time. The after image is not permanent and will disappear in a short period of time.
- 2) The LCD panel contained in this TV is manufactured using an extremely high level of precision technology; however, there may be an occasional pixel (dot of light) that does not operate properly (does not light, remains constantly lit, etc.). This is a structural property of LCD technology, is not a sign of malfunction, and is not covered under your warranty. Such pixels are not visible when the picture is viewed from a normal viewing distance. **Note:** Interactive video games that involve shooting a "gun" type of joystick at an on-screen target may not work on this TV.

Notes on handling

- Do not subject the LCD panel to physical shock, such as dropping it. It may cause unit damage and malfunction.
- When shipping the unit, the original shipping carton and packing materials come in handy. For fully protection, repack the unit as it was originally packed at the factory.
- Do not use volatile liquids, such as insecticide, near the unit. Do not leave rubber or plastic products in contact with the unit for prolonged periods of time. Doing so will leave marks on the finish.
- The top and rear panels of the unit may become warm after a long period of use. This is not a malfunction.
- When the unit is not in use, always remove the disc and turn off the power.

Notes on locating the unit

- When you place this unit near a TV, radio, or VCR, the playback picture may become poor and the sound may be distorted. In this case, place the unit away from the TV, radio, or VCR.
- To avoid damage to this product, never place or store the TV/DVD in direct sunlight; hot, humid areas; or areas subject to excessive dust or vibration.

Precautions (Continued)/Notes on discs

Notes on moisture condensation

Moisture condensation damages the unit. Please read the following carefully.

Moisture condensation occurs, for example, when you pour a cold drink into a glass on a warm day and drops of water form on the outside of the glass. In the same way, moisture may condense on this unit's internal optical pick-up lens, one of the most crucial internal parts of the unit.

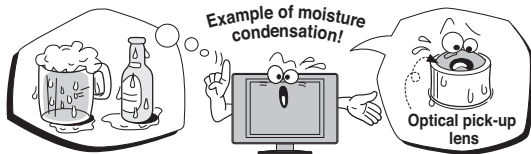

Moisture condensation may occur in the following situations:

- When you move the unit from a cold area to a warm area.
- When you use the unit in a room in which the heat was just turned on.
- When you use the unit in an area where cold air from an air conditioner directly hits the unit.
- When you use the unit in a humid area.



Never use the unit when moisture condensation may occur

Using the unit when moisture condensation exists may damage discs and internal parts. Connect the power cord of the unit to the wall outlet, turn on the unit, remove the disc, and leave it for two or three hours. After two or three hours, the unit will have warmed up and evaporated any moisture. Leaving the TV connected to the wall outlet will help prevent moisture condensation in the TV or DVD Player.

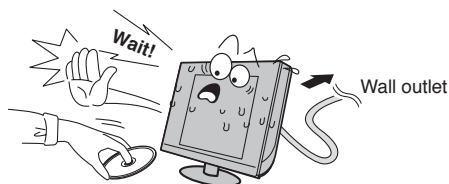

On handling discs

- Do not touch the playback side of the disc. For example, handle the disc so that it is shown in figure below.

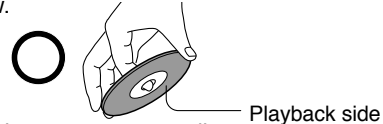

- Do not attach paper or tape to discs.



On cleaning discs

- Fingerprints and dust on the disc cause picture and sound deterioration. Wipe the disc from the center outwards with a soft cloth. Always keep the disc clean.



- Do not use any type of solvent such as thinner, benzene, commercially available cleaners or antistatic spray for vinyl LPs. It may damage the disc.

On storing discs

- Do not store discs in a place subject to direct sunlight or near heat sources.
- Do not store discs in places subject to moisture and dust such as a bathroom or near a humidifier.
- Store discs vertically in a case. Stacking or placing objects on discs outside of their case may cause warping.

Structure of disc contents

Normally, DVD video discs are divided into titles, and the titles are sub-divided into chapters. Video CDs and Audio CDs are divided into tracks.

DVD video disc

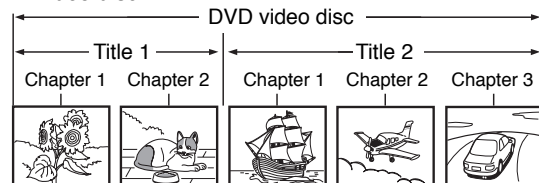

Video CD/Audio CD

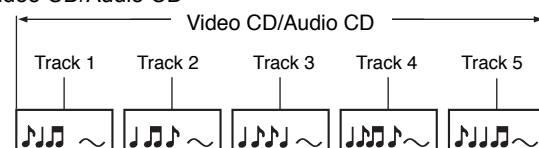

Each title, chapter or track is assigned a number, which is called "title number", "chapter number" or "track number" respectively.

There may be discs that do not have these numbers.

Notes on discs (Continued)

Notes on copyright

The unauthorized recording, use, distribution, or revision of copyrighted materials including, without limitation, television programs, videotapes, and DVDs, is prohibited under the Copyright Laws of the United States and other countries, and may subject you to civil and criminal liability.

This product incorporates copyright protection technology that is protected by method claims of certain U.S. patents and other intellectual property rights owned by Macrovision Corporation and other rights owners. Use of this copyright protection technology must be authorized by Macrovision Corporation, and is intended for home and other limited viewing uses only unless otherwise authorized by Macrovision Corporation.

Reverse engineering or disassembly is prohibited.

About this owner's manual

This owner's manual explains the basic instructions of this unit. Some DVD video discs are produced in a manner that allows specific or limited operation during playback. As such, the unit may not respond to all operating command. This is not a defect in the unit. Refer to instruction notes of discs.



The following symbol may appear on the TV screen during operation.



It means that the operation is not permitted by the TV/DVD or the disc.

For example, sometimes it is unable to stop the playback of copyright message of the disc when the STOP (■) button is pressed. Alternatively, this symbol may also indicate that the feature is not available for the disc.

Notes on region numbers

The region number of this unit is 1. If region numbers, which stand for their playable area, are printed on your DVD video disc and you do not find  or , disc playback will not be allowed by the player. (In this case, the unit will display a message on-screen.)

Some DVDs that have no region code label may still be subject to area restrictions and therefore not playable.

On Video CDs

This unit supports Video CDs equipped with the PBC (Version 2.0) function. (PBC is the abbreviation of Playback Control.) You can enjoy two playback variations depending on types of discs.

- **Video CD not equipped with PBC function (Version 1.1)**
Sound and movie can be played on this unit in the same way as a DVD.
- **Video CD equipped with PBC function (Version 2.0)**
In addition to operation of a Video CD not equipped with the PBC function, you can enjoy playback of interactive software with search function by using the menu displayed on the TV screen (Menu Playback). Some of the functions described in this owner's manual may not work with some discs.

Playable discs

This unit can play the following discs.

	Disc Mark	Contents	Disc Size	Maximum playback time
DVD video discs		Audio + Video (moving pictures)	12 cm	Approx. 4 hours (single sided disc)
				Approx. 8 hours (double sided disc)
			8 cm	Approx. 80 minutes (single sided disc)
				Approx. 160 minutes (double sided disc)
Video CDs		Audio + Video (moving pictures)	12 cm	Approx. 74 minutes (single sided disc)
			8 cm	Approx. 20 minutes (single sided disc)
Audio CDs		Audio	12 cm	Approx. 74 minutes (single sided disc)
			8 cm	Approx. 20 minutes (single sided disc)
DivX®		Audio + Video (moving pictures)	12 cm	It depends on DivX® quality
			8 cm	

The following discs are also available.

- DVD-R/RW discs of DVD video format
 - CD-R/CD-RW discs of CD-DA, Video CD, MP3, WMA, JPEG or DivX® format
 - Kodak Picture CD and FUJICOLOR CD format
- Some of these discs may be incompatible.

- You cannot play discs other than those listed above.
- You cannot play discs of DVD-RAM, DVD-ROM, CD-ROM, Photo CD, etc., or non standardized discs even if they may be labeled as above.
- Some CD-R/RWs cannot be played back depending on the recording conditions.
- This unit uses the NTSC color system, and cannot play DVD video discs recorded in any other color system (PAL, SECAM, etc.).
- This unit can play an 8cm disc. Please do not use a disc adapter. It may cause trouble.
- Please do not insert any disc of an irregular shape into the unit, as it may interfere with the function of the unit. You may not be able to remove it.
- Please do not use after market accessories, such as a ring protector, as this may cause trouble with the operation of the unit.

Because of problems and errors that can occur during the creation of DVD and CD Software and/or the manufacture of DVD and CD discs, Toshiba cannot assure that the DVD player contained in this TV will successfully play every disc bearing the DVD and CD logos.

If you happen to experience any difficulty playing a DVD and/or CD disc on the DVD player contained in this TV, please contact Toshiba Customer Service.

 is a trademark of DVD Format/Logo Licensing Corporation.

Contents

Introduction

SAFETY INSTRUCTIONS.....	4
Precautions.....	6
Notes on discs.....	7
Contents.....	9
Identification of controls.....	10

Connections

Antenna connections.....	14
Cable TV connections.....	15
Connecting to optional equipment.....	16
Power source.....	20

Basic setup

Auto setup.....	21
Setting the language.....	22
To memorize channels.....	23

TV operation

TV operation.....	26
Labeling channels.....	28
Labeling video inputs.....	29
Setting the V-Chip.....	30
Setting the closed captions.....	34
CC advanced.....	35
Adjusting the picture preference.....	36
Picture settings.....	36
Viewing the wide-screen picture formats.....	37
Film Mode.....	38
DNR.....	38
Picture control adjustment in the PC mode.....	39
Sound control adjustment.....	40
Selecting Stereo/Second Audio Program (SAP).....	40
Selecting the audio language.....	41
Selecting the HDMI audio input source.....	41
Using the aspect feature.....	42
Adjusting the back lighting.....	42
Setting the Auto Shut Off.....	43
Resetting your settings.....	43

Basic playback

Playing a disc.....	44
---------------------	----

Advanced playback

Zooming.....	47
Locating desired scene.....	47
Marking desired scenes.....	48
Repeat playback.....	49
A-B Repeat playback.....	49
Program playback.....	50
Random playback.....	50
Changing angles.....	51
Title selection.....	51
DVD menu.....	51
Changing soundtrack language.....	52
Subtitles.....	52
Disc status.....	53
To turn off the PBC.....	53
MP3/WMA/JPEG/DivX® and Audio CD operation.....	54
Repeat, random and program playback using file browser.....	58

Function setup

Customizing the function settings.....	60
Temporary cancel the rating level by DVD disc.....	65

Others

Understanding the Power Return feature.....	66
Troubleshooting.....	66
Reception disturbances.....	68
Language code list.....	69
Specifications.....	70
Limited United States Warranty.....	71

Identification of controls

Front

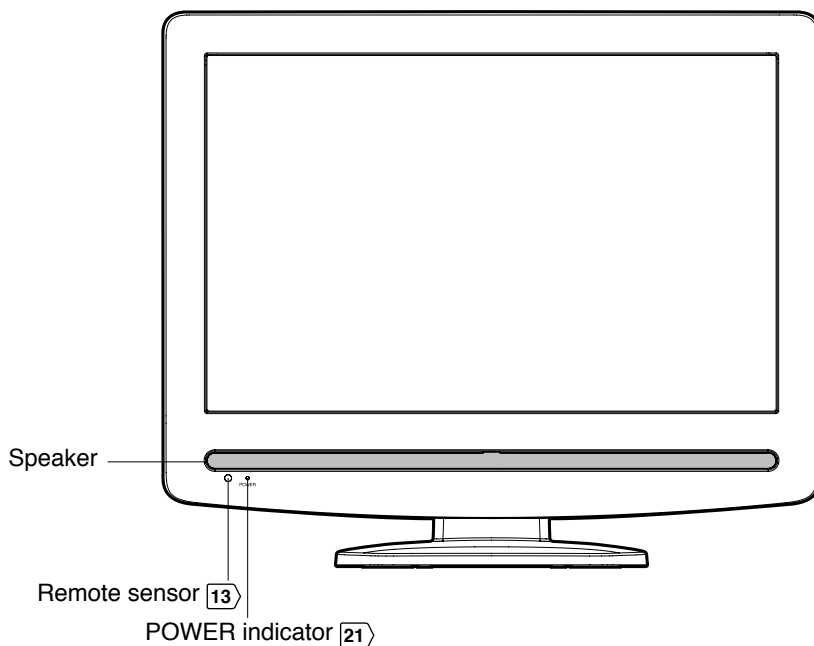
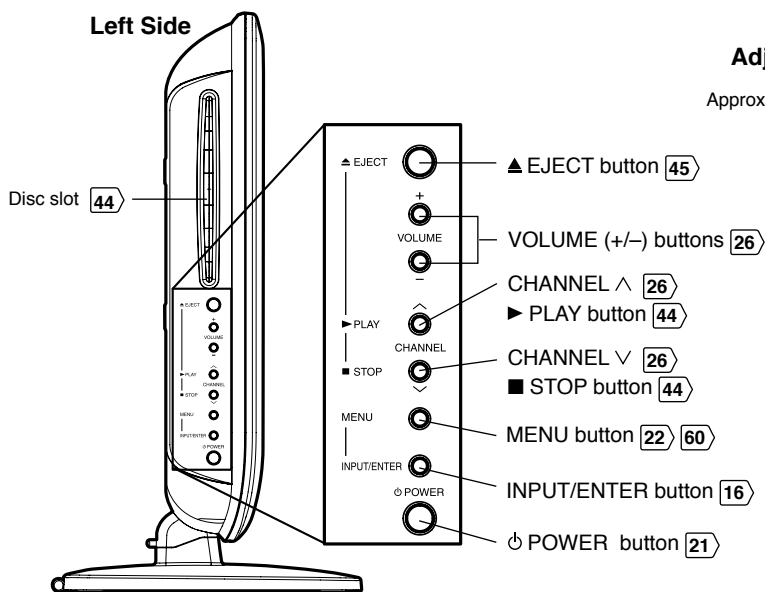

Illustration of 19LV505

Side



Adjusting the angle of the base

Approx. 10° 0° Approx. 3°

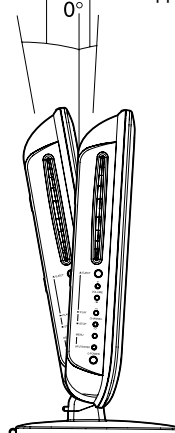

You can adjust the angle of the TV-screen for 3° forward or for 10° backward from vertical angle. Hold the base of the TV while adjusting the angle.

Illustration of 19LV505

Rear

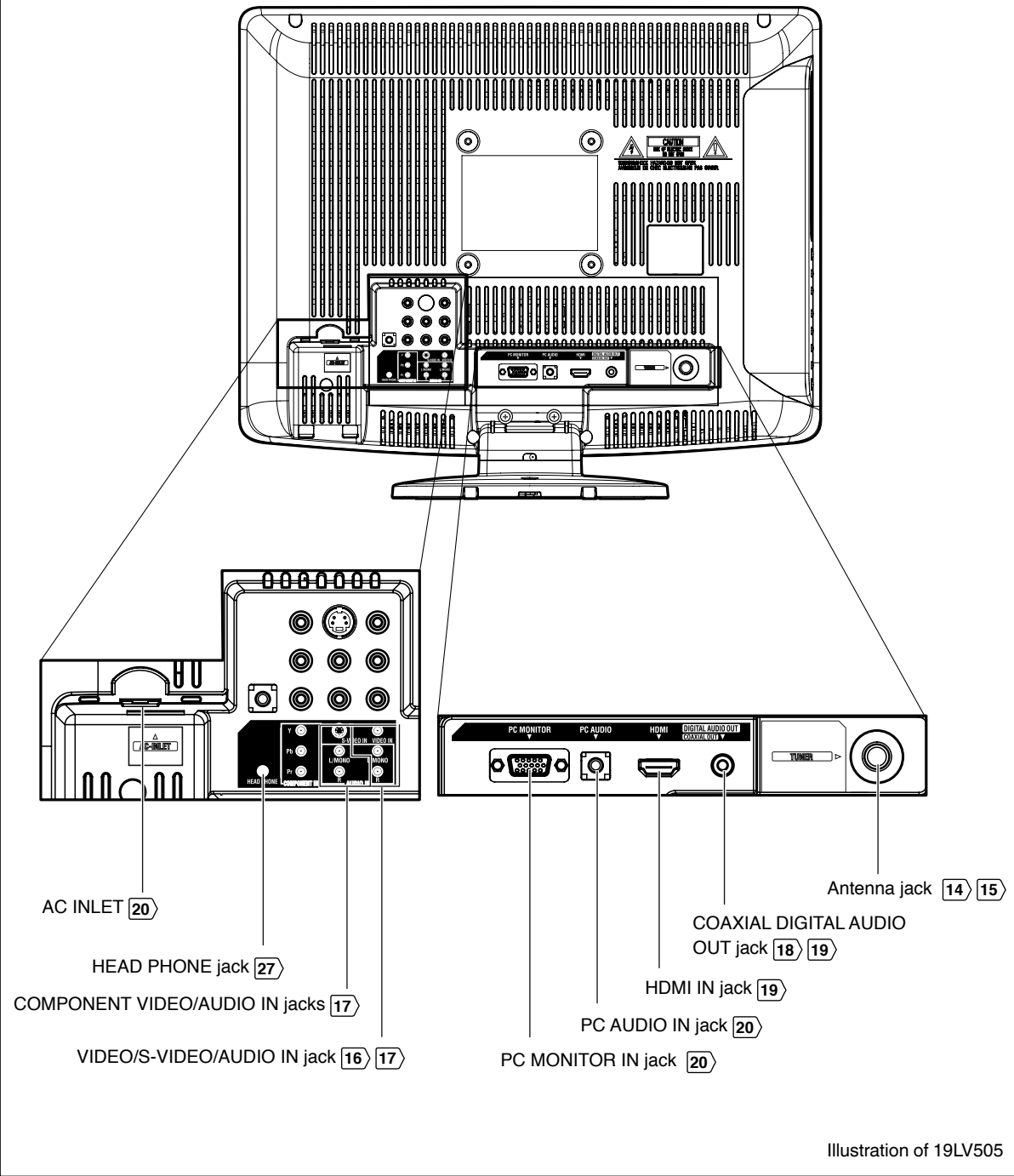
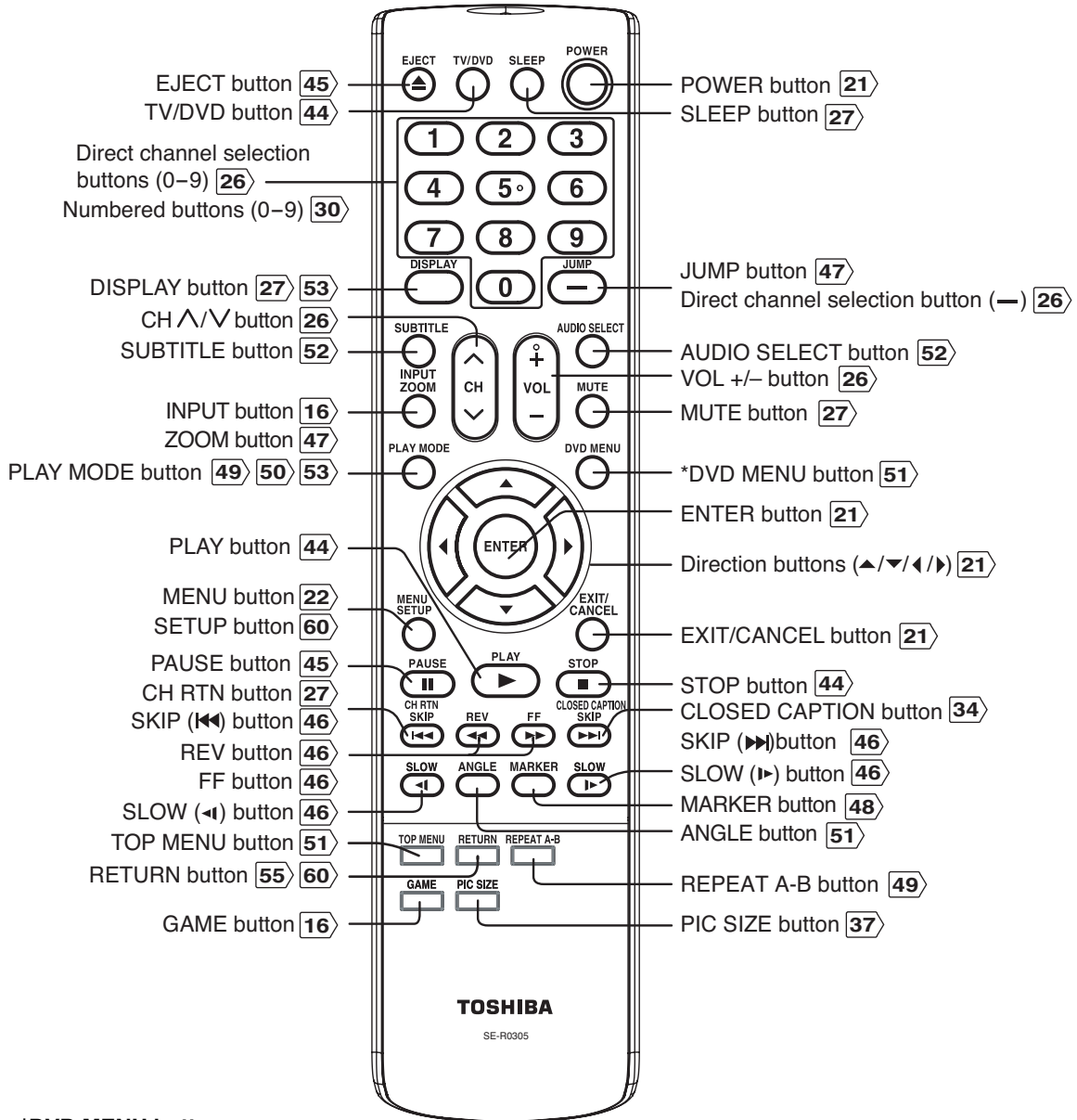

Illustration of 19LV505

Identification of controls (Continued)

Remote control

The instructions in this manual describe the function on the remote control. See the page in for details.



***DVD MENU button**

Use the DVD MENU button to display the menu included on many DVD video discs.

To operate a menu, follow the instructions in "DVD menu." 51

Inserting batteries

- 1 Open the battery compartment cover in the direction of the arrow.
- 2 Install two "R03/AAA" batteries (supplied), paying attention to the polarity indicated in the battery compartment.
- 3 Replace the compartment cover.

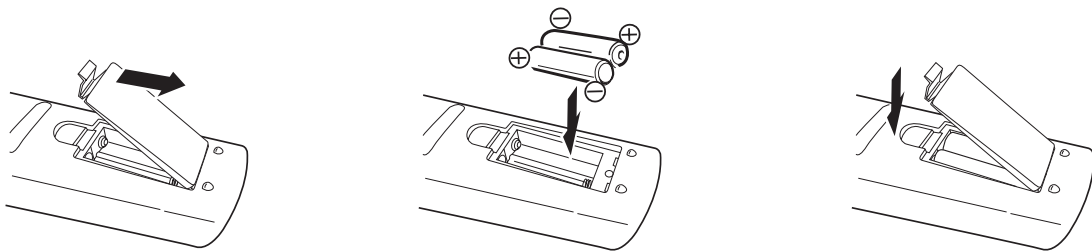

Operation

- Aim the remote control at the remote sensor and press control buttons to operate.
- Operate the remote control within 30° angle on either side of the remote sensor, up to a distance of approx. 5 meters.

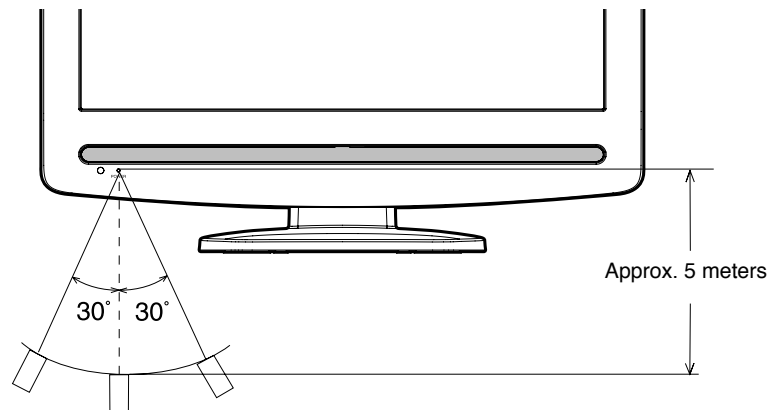

Caution:

- Never throw batteries into a fire.

Note:

- Be sure to use AAA size batteries.
- Dispose of batteries in a designated disposal area.
- Batteries should always be disposed of with the environment in mind. Always dispose of batteries in accordance with applicable laws and regulations.
- If the remote control does not operate correctly, or if the operating range becomes reduced, replace batteries with new ones.
- When necessary to replace batteries in the remote control, always replace both batteries with new ones. Never mix battery types or use new and used batteries in combination.
- Always remove batteries from remote control if they are dead or if the remote control is not to be used for an extended period of time. This will prevent battery acid from leaking into the battery compartment.

Antenna connections

If you are using an indoor or outdoor antenna, follow the instructions below that correspond to your antenna system.
If you are using a cable TV service (CABLE), see page 15 for Cable TV connections.

Combination VHF/UHF antenna (Single 75 ohm cable or 300 ohm twin-lead wire)

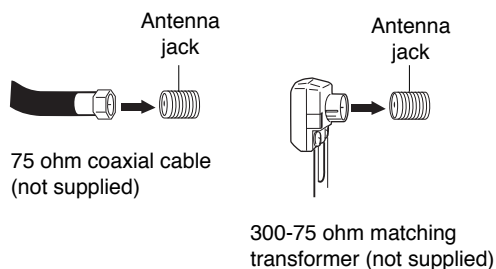

Connect the 75 ohm cable from the combination VHF/UHF antenna to the antenna jack on the back of the TV/DVD.

If your combination VHF/UHF antenna has a 300 ohm twin-lead wire, use the 300-75 ohm matching transformer (not supplied).

Combination VHF/UHF antenna (Separate VHF and UHF 300 ohm twin-lead wires)

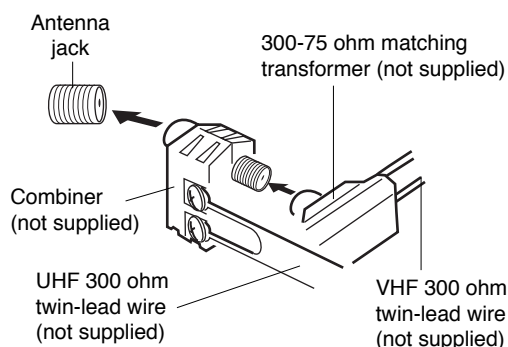

Connect the UHF 300 ohm twin-lead wire to the combiner (not supplied). Connect the VHF 300 ohm twin-lead wire to the 300-75 ohm matching transformer (not supplied). Attach the transformer to the combiner, then attach the combiner to the antenna jack on the back of the TV/DVD.

Separate VHF/UHF antennas (75 ohm VHF cable and 300 ohm UHF twin-lead wires)

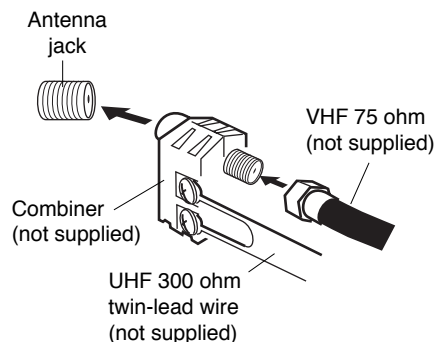

Connect the VHF 75 ohm cable and UHF 300 ohm twin-lead wire to the combiner (not supplied). Attach the combiner to the antenna jack on the back of the TV/DVD.

Cable TV connections

This TV/DVD has an extended tuning range and can tune most cable channels without using a Cable TV converter box. Some cable companies offer "premium pay channels" in which the signal is scrambled. Descrambling these signals for normal viewing requires the use of a descrambler device which is generally provided by the cable company.

For subscribers to basic cable TV service

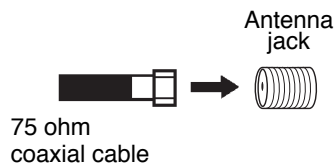

For basic cable service not requiring a converter/descrambler box, connect the Cable TV 75 ohm coaxial cable directly to the Antenna jack on the back of the TV/DVD.

For subscribers to scrambled cable TV service

If you subscribe to a cable TV service which requires the use of a converter/descrambler box, connect the incoming 75 ohm coaxial cable to the converter/descrambler box. Using another 75 ohm coaxial cable, connect the output jack of the converter/descrambler box to the antenna jack on the TV/DVD. Follow the connections shown below. Set the TV/DVD to the output channel of the converter/descrambler box (usually channel 3 or 4) and use the converter/descrambler box to select channels.

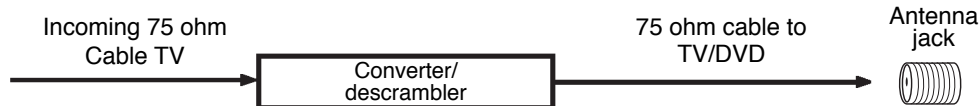

For subscribers to unscrambled basic cable TV service with scrambled premium channels

If you subscribe to a cable TV service in which basic channels are unscrambled and premium channels require the use of a converter/descrambler box, you may wish to use a signal splitter and an A/B Switch box (available from the cable company or an electronics supply store). Follow the connections shown below. With the switch in the "B" position, you can directly tune any unscrambled channels on your TV/DVD. With the switch in the "A" position, tune your TV/DVD to the output of the converter/descrambler box (usually channel 3 or 4) and use the converter/descrambler box to tune scrambled channels.

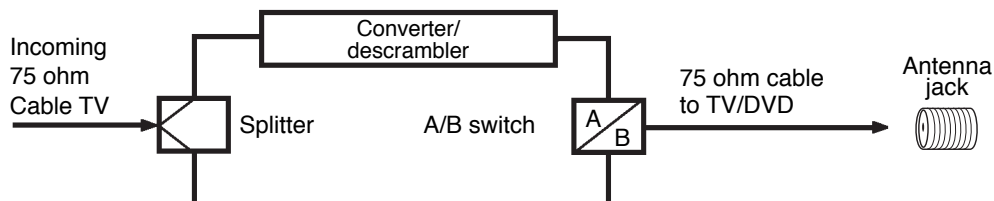

Connecting to optional equipment

You can enjoy VCR, camcorder or TV game with connection to external input.

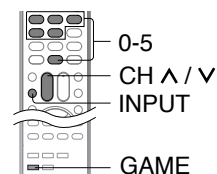

Using the audio/video inputs

Press **INPUT** to view a signal from another device connected to your TV/DVD, such as a VCR player. You can select TV, Video, ColorStream HD, HDMI or PC depending on which input jacks you used to connect your devices.

Press **INPUT** on the remote control to display the current signal source. To change the input source, press **INPUT** again or press **0-4**. (**5** is for selection DVD mode.)

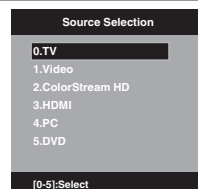

Connecting to a VCR

To playback from the VCR, connect the VCR to the TV/DVD as shown. Select the "Video" by pressing **INPUT** repeatedly.

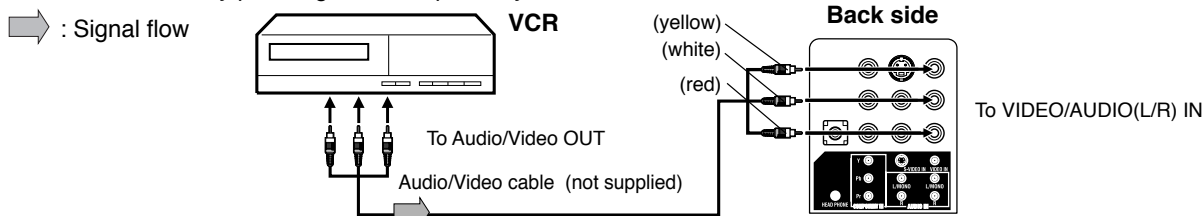

Connecting to a camcorder

To playback from the camcorder, connect the camcorder to the TV/DVD as shown. Select the "Video" by pressing **INPUT** repeatedly.

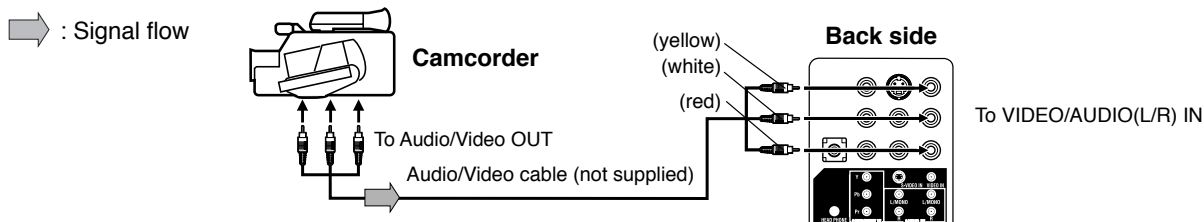

Connecting to a TV Game

You can enjoy playing a TV game on the screen by adjusting to the suitable brightness for your eyes.

1. Connect a TV Game to the TV/DVD.
2. Select the Game mode by pressing **GAME**. The Game mode screen appears.
 - If **GAME** is pressed during standby mode, the unit turns on automatically and the Game mode screen appears on the screen.

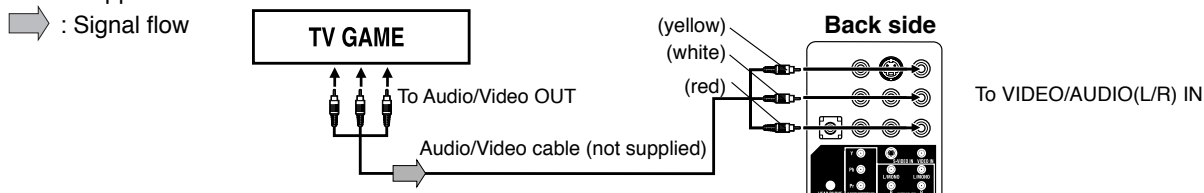

Note:

- You can also change the TV/DVD screen to the desired mode by pressing the **CH ^ / V**.
- The TV/DVD can also be used as a display device for many video games. However, due to the wide variety of different types of signal generated by these devices and subsequent hook-up variations required, they have not all been included in the suggested connection diagrams. You'll need to consult each component's Owner's Manual for additional information.
- Interactive video games that involve shooting a "gun" type of joystick at on-screen target may not work on this TV/DVD.

Connecting to an optional equipment with S-video output

If you connect a VCR with an S-Video cable to the S-VIDEO IN jack on the left side of the TV/DVD, you must also connect the audio cables to the AUDIO IN jacks as shown below. The S-Video cable only carries the video signal. The audio signal is separated.

Select the "Video" by pressing **INPUT** repeatedly.

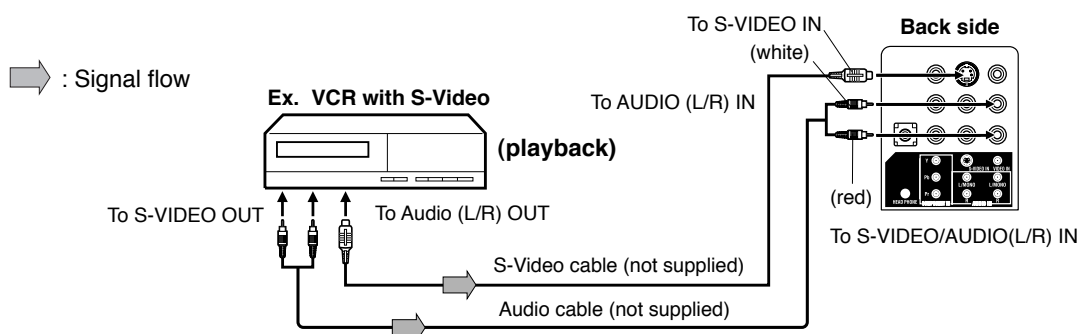

Note:

- When the S-Video cable and the standard video cable are connected at the same time, the S-video cable takes precedence.

Connecting an optional equipment with ColorStream® (Component video) output

Your TV/DVD is capable of using ColorStream® (component video). Connecting your TV/DVD to a component video compatible DVD player, such as a Toshiba DVD player with ColorStream® can greatly enhance picture quality and performance.

Select the "ColorStream HD" by pressing **INPUT** repeatedly.

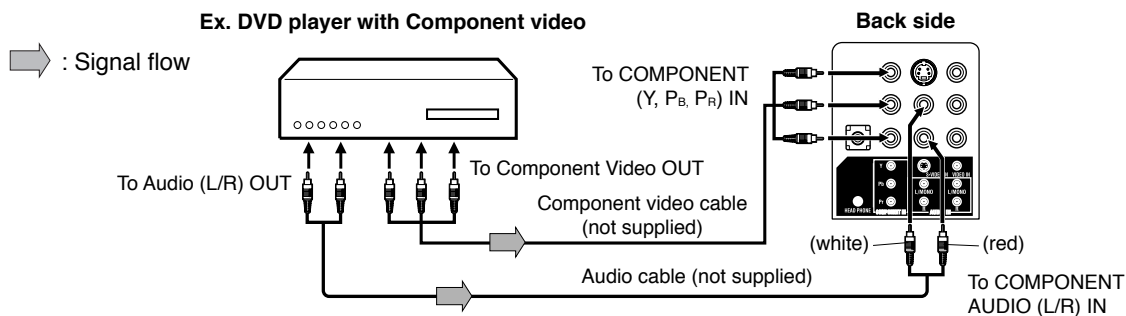

When using the Component video cable, an Audio cable must be connected to COMPONENT AUDIO(L/R) IN jacks.

Note:

- The ColorStream® (COMPONENT) inputs on this unit are for use with devices that output 480i, 1080i interlaced signals and 480p, 720p progressive signals.
- Refer to the owner's manual of the connected equipment as well.
- When you connect the unit to other equipment, be sure to turn off the power and unplug all of the equipment from the wall outlet before making any connections.
- If you place the unit near a tuner or radio, the radio broadcast sound might be distorted. In this case, place the unit away from the tuner and radio.

Connecting to optional equipment (Continued)

You can enjoy high quality dynamic sounds by connecting the TV/DVD to optional audio equipment.

* This section uses the following reference mark.

- : Front speaker
- : Rear speaker
- : Sub woofer
- : Center speaker
- ⇒ : Signal flow

Connecting to an amplifier equipped with a Dolby® Digital decoder

Dolby Digital

Dolby Digital is the surround sound technology used in theaters showing the latest movies, and is now available to reproduce this realistic effect in the home. You can enjoy motion picture and live concert DVD video discs encoded via the Dolby Digital recording system with this dynamic realistic sound by connecting the TV/DVD to a 6 channel amplifier equipped with a Dolby Digital decoder or Dolby Digital processor. If you have a Dolby Surround Pro Logic decoder, you will obtain the full benefit of Pro Logic from the same DVD movies that provide full 5.1-channel Dolby Digital soundtracks, as well as from titles with the Dolby Surround mark.

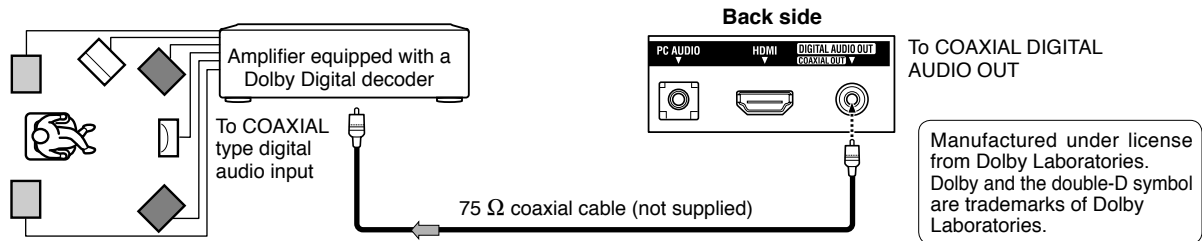

Connecting to an amplifier equipped with a DTS® decoder

Digital Theater Systems (DTS)

DTS is a high quality surround technology used in theaters and now available for home use, on DVD video discs or audio CDs. If you have a DTS decoder or processor, you can obtain the full benefit of 5.1 channel DTS encoded sound tracks on DVD video discs or audio CDs.

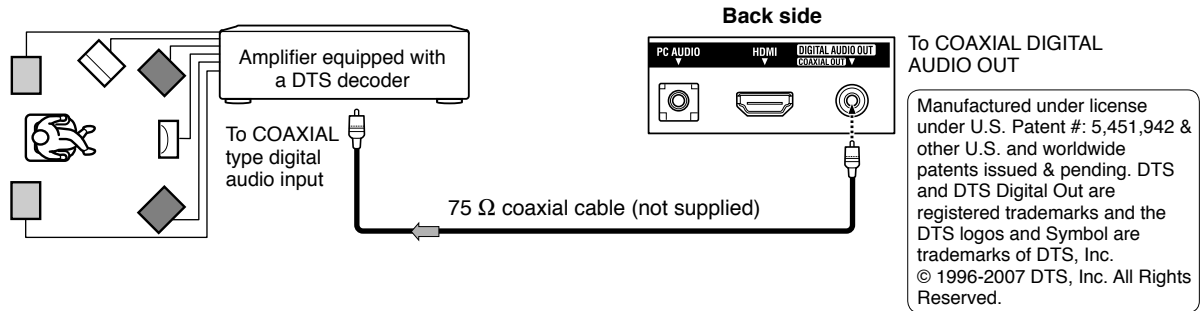

Connecting to an amplifier equipped with an MPEG audio decoder

MPEG2 sound

You can enjoy motion picture and live concert DVD video discs encoded via the MPEG2 recording system with dynamic realistic sound by connecting an amplifier equipped with an MPEG2 audio decoder or MPEG2 audio processor.

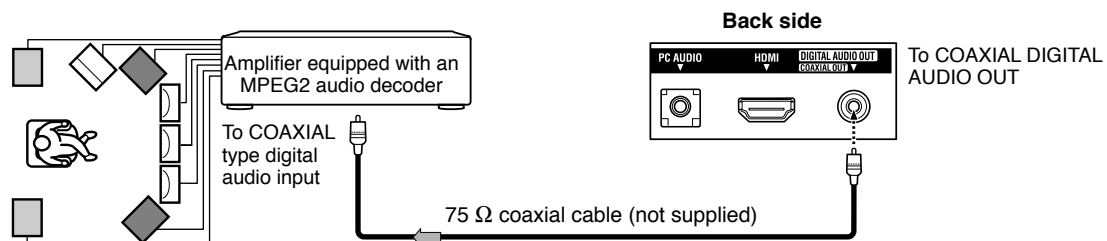

Connecting to an amplifier equipped with a digital audio input

2 channel digital stereo

You can enjoy the dynamic sound of 2 channel digital stereo by connecting an amplifier equipped with a digital audio input and speaker system (right and left front speakers).

Note: PCM audio is limited to DVD or CD playback.

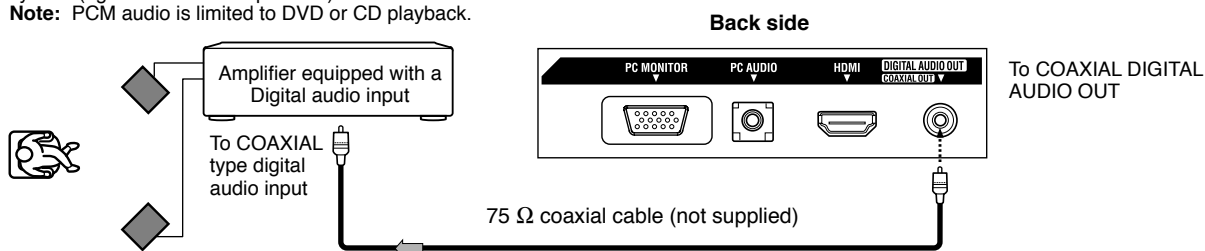

Note:

- DO NOT connect the COAXIAL DIGITAL AUDIO OUT jack of the TV/DVD to the AC-3 RF input of a Dolby Digital Receiver. This input on your A/V Receiver is reserved for Laserdisc use only and is incompatible with the COAXIAL DIGITAL AUDIO OUT jack of the TV/DVD.
- Connect the COAXIAL DIGITAL AUDIO OUT jack of the TV/DVD to the "COAXIAL" input of a Receiver or Processor.
- Refer to the owner's manual of the connected equipment as well.
- When you connect the TV/DVD to other equipment, be sure to turn off the power and unplug all of the equipment from the wall outlet before making any connections.
- The output sound of the TV/DVD has a wide dynamic range. Be sure to adjust the receiver's volume to a moderate listening level. Otherwise, the speakers and your hearing may be damaged by a sudden high volume sound.
- Turn off the amplifier before you connect or disconnect the TV/DVD's power cord. If you leave the amplifier's power on, the speakers may be damaged.

Connecting to an HDMI or a DVI device

About HDMI

HDMI (High Definition Multimedia Interface) supports both video and audio on a single digital connection for use with DVD players, DTV, set-top boxes, and other AV devices. HDMI was developed to provide the technologies of High Bandwidth Digital Content Protection (HDCP) as well as Digital Visual Interface (DVI) in one specification. HDCP is used to protect digital content transmitted and received by DVI-compliant or HDMI-compliant displays.

HDMI has the capability to support standard, enhanced, or high-definition video plus standard to multi-channel surround-sound audio. HDMI features include uncompressed digital video, a bandwidth of up to 2.2 gigabytes per second (with HDTV signals), one connector (instead of several cables and connectors), and communication between the AV source and AV devices such as DTVs.

HDMI, the HDMI logo and High-Definition Multimedia Interface are trademarks or registered trademarks of HDMI licensing LLC.

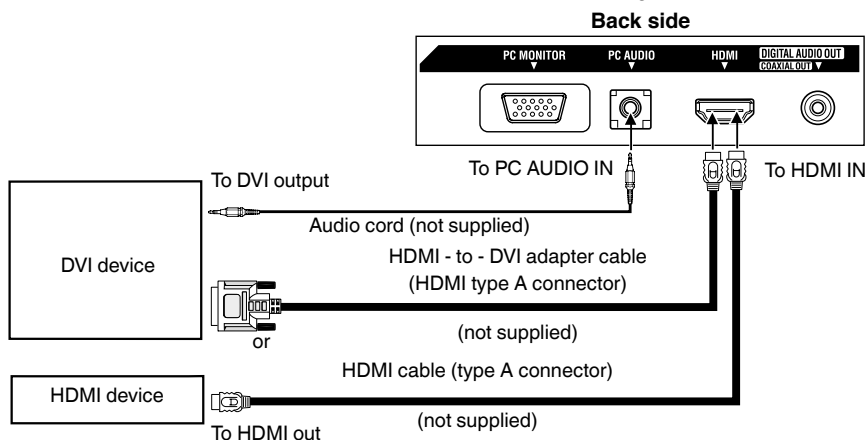

Note:

- You must select the corresponding audio input source (HDMI or DVI) on the menu screen (see "Selecting the HDMI audio input source" on page 41). Otherwise you will only see the image with no sound.

Connecting to optional equipment (Continued)/ Power source

Connecting to a PC (Personal Computer)

Before you connect this TV/DVD to your PC, change the adjustment of your PC's Resolution and Refresh rate (60 Hz). Connect one end of a (male to male) VGA cable to the video card of the computer and the other end to the VGA connector PC MONITOR on the rear of the TV/DVD. Attach the connectors firmly with the screws on the plug. In case of a Multimedia computer, connect the audio cord to the audio output of your Multimedia computer and to the AUDIO connector of the PC AUDIO IN jack of the TV/DVD.

Select "PC" by pressing **INPUT** repeatedly.

Switch on the computer. The TV/DVD can operate as the computer monitor

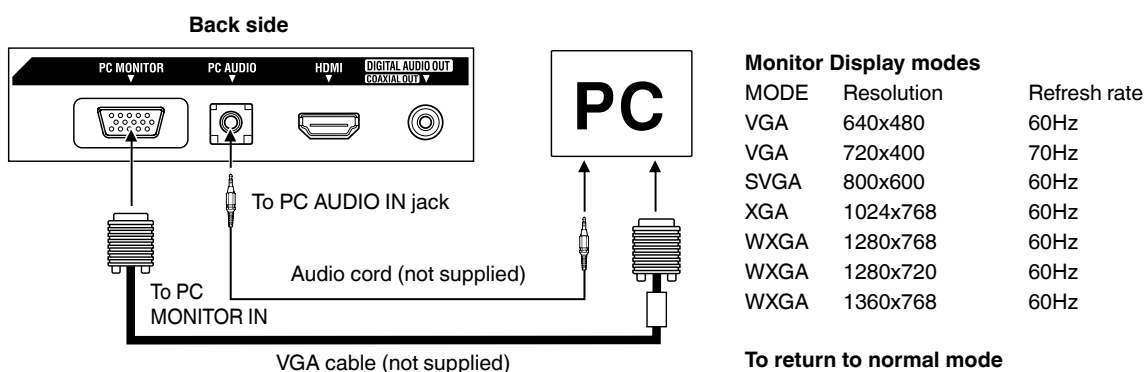

Note:

- The on-screen displays will have a different appearance in PC mode than in TV mode.
- If there is no video signal from the PC when the unit is in PC mode, "No signal" will appear on the TV/DVD-screen.

Power source

To use AC power source

1. Connect the AC cord plug into this TV/DVD's AC INPUT jack.
2. Connect the AC cord into an AC outlet.

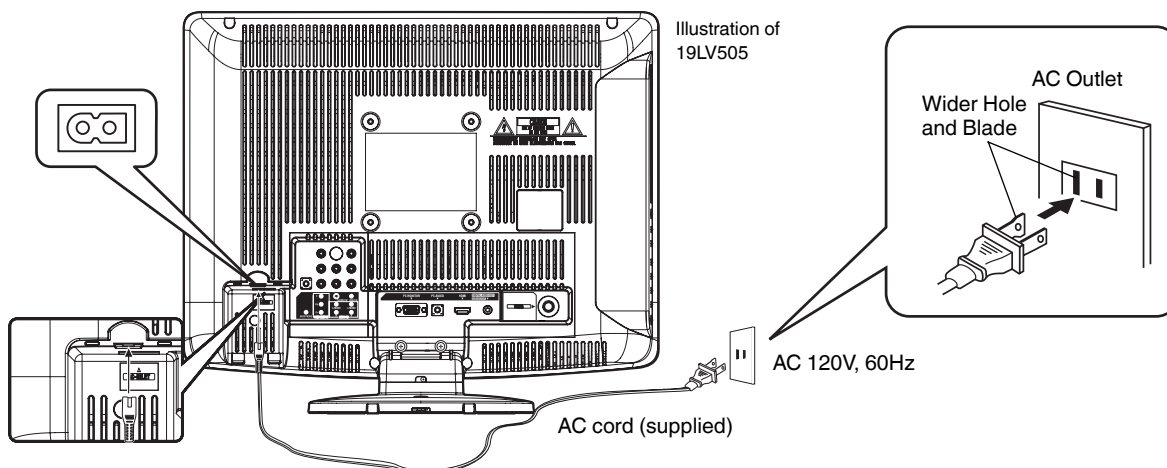

Note:

- Never connect the AC line cord plug to other than the specified voltage (120V 60Hz). Use the attached power cord only.
- If the polarized AC cord does not fit into a non-polarized AC outlet, do not attempt to file or cut the blade. It is the user's responsibility to have an electrician replace the obsolete outlet.
- If you cause a static discharge when touching the unit and the unit fails to function, simply unplug the unit from the AC outlet and plug it back in. The unit should return to normal operation.
- If the AC cord plug is plugged in for the first time, wait for approx. 5 seconds before pressing **POWER**.

Auto Setup

The Auto Setup function helps to install your TV/DVD easily. It leads you the Language selection, Air/Cable selection and Automatic channel search.

IMPORTANT: Make sure that the antenna or cable TV system connection is made!

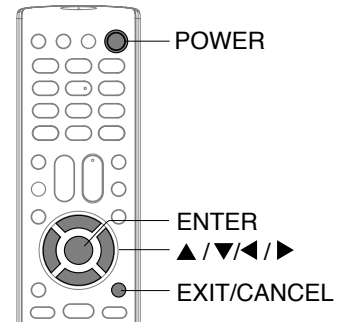

Auto Setup

- 1** To turn on the TV/DVD, press **POWER**.
- POWER indicator on the front of the unit changes green. It may take approx. 10 seconds for a picture to appear on screen.



- 2** Auto Setup menu appears on the screen. Press **▲** or **▼** to select "Language", then press **◀** or **▶** to select your desired language.

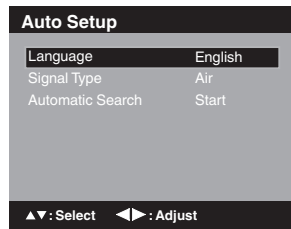
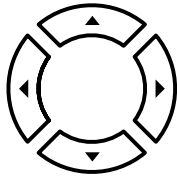

- 3** Press **▲** or **▼** to select "Signal Type", then press **◀** or **▶** to select "Air" or "Cable".

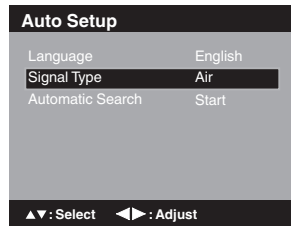
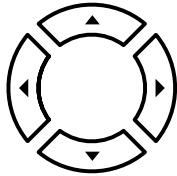

Air - VHF/UHF channels
Cable - Cable TV channels

- 4** Press **▲** or **▼** to select "Automatic Search", then press **ENTER**.

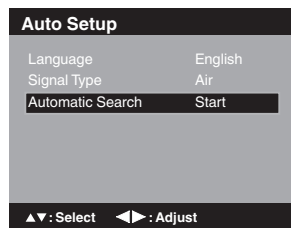

- 5** Now the "Automatic Search" starts.

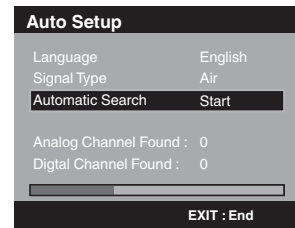

- If you press **EXIT/CANCEL**, the Automatic Search stops and changes to the TV screen.
- After the starting setup is completed, the TV channel appears on the screen.

Note:

- The Auto Setup function will work only when you press **POWER** for the first time.
- The process of "Automatic Search" may take 15 to 30 minutes to complete, depending on your regional cable service.

Setting the language

This TV/DVD can display the on screen language in English, French or Spanish.
Select the language you prefer first, then proceed with the other menu options.

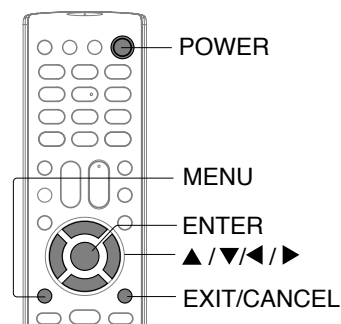

Setting the language

- 1** To turn on the TV/DVD, press **POWER**.
- POWER indicator on the front of the unit changes green. It may take approx. 10 seconds for a picture to appear on screen.



- 2** Press **MENU**. The TV menu screen will appear. Press **▲** or **▼** to select "Setup", then press **▶** or **ENTER**.

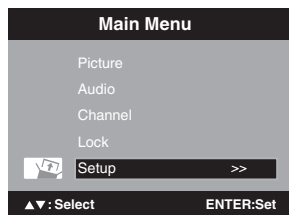
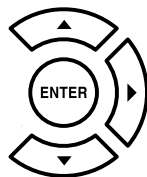

- 3** Press **▲** or **▼** to select "Language".

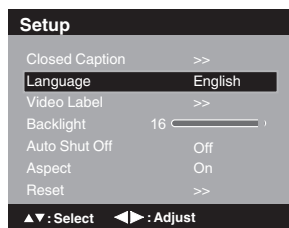

- 4** Press **◀** or **▶** to select the desired language: English, French (Français) or Spanish (Español).

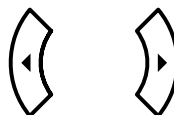

- 5** Press **EXIT/CANCEL** to return to the normal screen.



Note:

- If the unit does not operate properly, or No key operation (by the unit and/or the remote control): Static electricity, etc., may affect the TV/DVD's operation. In such case, disconnect the AC cord once, then connect it again.
- If no buttons are pressed for more than about 60 seconds, the MENU screen will return to normal operation automatically.

To memorize channels

This TV/DVD is equipped with a channel memory feature which allows channels to skip up or down to the next channel set into memory, skipping over unwanted channels. Before selecting channels, they must be programmed into the TV/DVD's memory. To use this TV/DVD with an antenna, set the Tuning Band menu option to the Air mode. When shipped from the factory, this menu option is in the Cable mode.

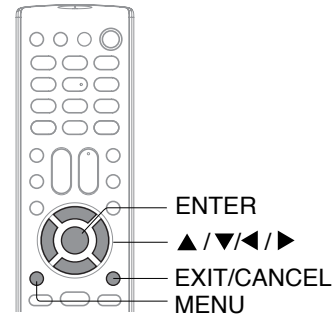

Air/Cable selection

- 1 Press MENU in the TV mode. The TV menu screen will appear. Press ▲ or ▼ to select "Channel", then press ► or ENTER.

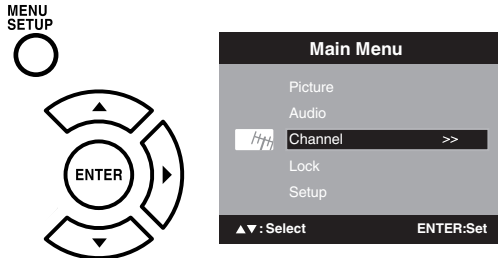

- 2 Press ▲ or ▼ to select "Auto Ch Memory", then press ► or ENTER.

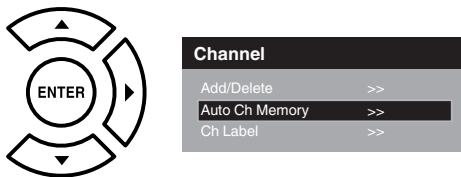

- 3 Press ▲ or ▼ to select "Signal Type".

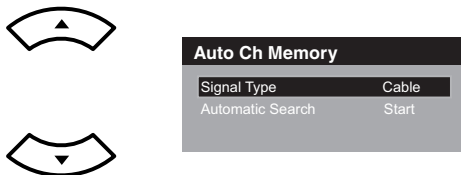

- 4 Press ◀ or ▶ to select "Air" or "Cable".

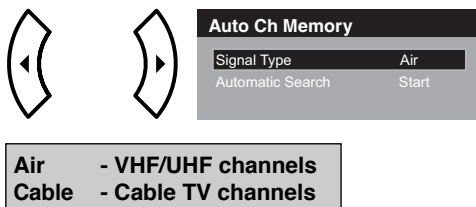

- 5 Press EXIT/CANCEL to return to the normal screen.



Automatic search

- 1 Press MENU in the TV mode. The TV menu screen will appear. Press ▲ or ▼ to select "Channel", then press ► or ENTER.

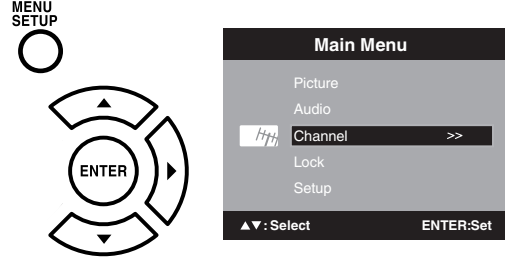

- 2 Press ▲ or ▼ to select "Auto Ch Memory", then press ► or ENTER.

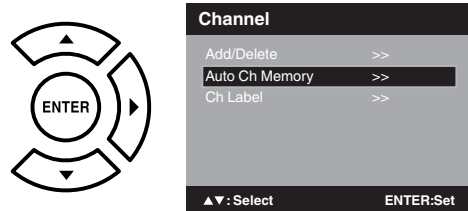

- 3 Press ▲ or ▼ to select "Automatic Search", then press ENTER.

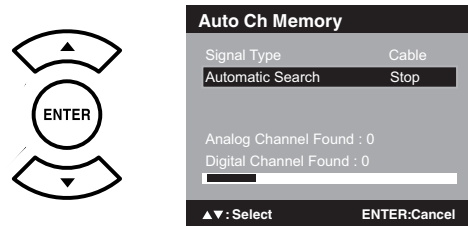

- 4 The TV/DVD will begin memorizing all the channels available in your area.

To memorize channels (Continued)

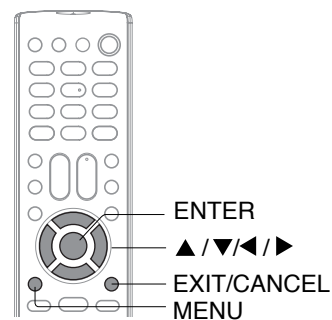

Add/Delete channel

You can select the channel that you want to skip.

1 Press **MENU** in the TV mode. The TV menu screen will appear. Press **▲** or **▼** to select “Channel”, then press **▶** or **ENTER**.

Main Menu

- Picture
- Audio
- Channel >>**
- Lock
- Setup

▲▼: Select ENTER:Set

2 Press **▲** or **▼** to select “Add/Delete”, then press **▶** or **ENTER**.

Channel

- Add/Delete >>**
- Auto Ch Memory >>
- Ch Label >>

▲▼: Select ENTER:Set

3 Press **▲** or **▼** to select “Add/Delete”, then press **▶** or **ENTER**.

Add/Delete

- Adding Channel >>
- Add/Delete >>**
- Clear All >>

▲▼: Select ENTER:Set

4 Press **▲** or **▼** to select the channel that you want to skip.

Add/Delete

▲ CH	Signal	
2	Analog	Add
3	Analog	Add
3-001	Digital	Delete
3-002	Digital	Add
4	Analog	Delete

▲▼: Select ◀▶: Adjust

5 Press **◀** or **▶** to select “Add” or “Delete”, whichever function you want to perform.

Add/Delete

▲ CH	Signal	
2	Analog	Delete
3	Analog	Add
3-001	Digital	Delete
3-002	Digital	Add
4	Analog	Delete

▲▼: Select ◀▶: Adjust

6 Repeat steps 4 - 5 for other channels you want to add or delete.

7 Press **EXIT/CANCEL** to return to the normal screen.

EXIT/CANCEL

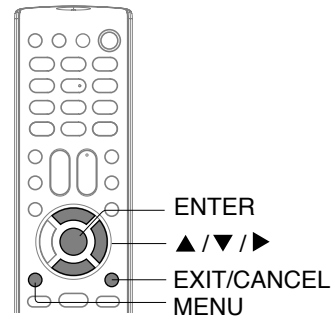

Adding Channel

If you find a new channel unregistered, you can add the new channel into the channel memory.

1 Tune in the new channel.

2 Press MENU. The TV menu screen will appear. Press ▲ or ▼ to select "Channel", then press ▶ or ENTER.

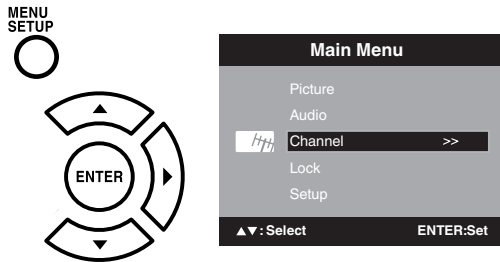

3 Press ▲ or ▼ to select "Add/Delete", then press ▶ or ENTER.

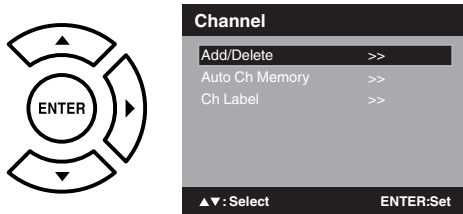

4 Press ▲ or ▼ to select "Adding Channel", then press ▶ or ENTER. The new channel will be added into the channel memory.

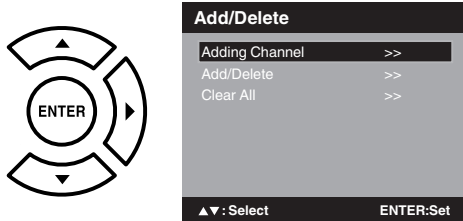

5 Press EXIT/CANCEL to return to the normal screen.



Clear All

All channels are deleted from the channel memory.

1 Press MENU in the TV mode. The TV menu screen will appear. Press ▲ or ▼ to select "Channel", then press ▶ or ENTER.

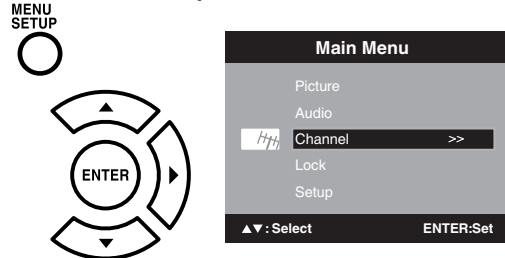

2 Press ▲ or ▼ to select "Add/Delete", then press ▶ or ENTER.

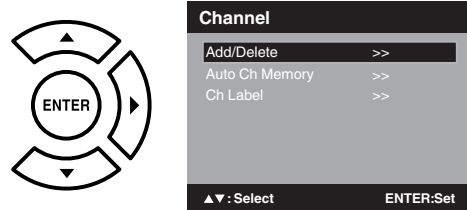

3 Press ▲ or ▼ to select "Clear All", then press ▶ or ENTER.

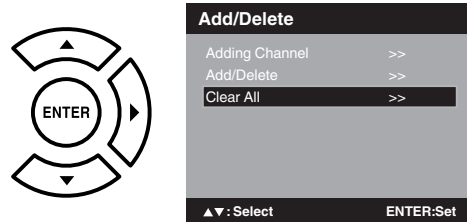

4 Press EXIT/CANCEL to return to the normal screen.



TV operation

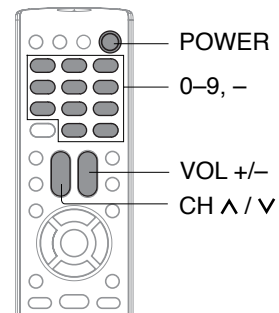

TV operation

1 To turn on the TV/DVD, press **POWER**. (POWER indicator on the front of the unit changes green. It may take approx. 10 seconds for a picture to appear on screen.)

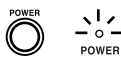

2 Adjust the volume level by pressing **VOL +** or **-**. The volume level will be indicated on the screen by blue bars. As the volume level increases, so do the number of bars. If the volume decreases, the number of blue bars also decreases.



3 Set the Signal Type option to the appropriate position (see "Air/Cable selection" on page 23).

Air - VHF/UHF channels
Cable - Cable TV channels

4 Press the **Direct Channel Selection (0-9, -) buttons** or **CH ^ / V** to select the channel. (If you press only channel number, channel selection will be delayed for a few seconds.)

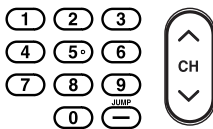

TO SELECT ANALOG CHANNELS

- 1-9: Press 1-9 as needed. Example, to select channel 2, press **2**.
- 10-99: Press the 2 digits in order. Example, to select channel 12, press **1, 2**.
- 100-125: Press the 3 digits in order. Example, to select channel 120, press **1, 2, 0**.

TO SELECT DIGITAL CHANNELS

Press the first 3 digits, then press the **-** button, followed by the remaining number.

Example, to select channel 015-001, press **0, 1, 5, -, 1**.

- If a channel is selected with only audio content, "Audio only" will be displayed on the screen.
- If a channel is selected with a weak digital signal, "Digital channel signal strength is low" will be displayed on the screen.
The same program may be available on either an analog channel or a digital channel. You may choose to watch either format.
- If a channel is selected to which you have not subscribed, "Digital channel is encrypted" will be displayed on the screen.

VHF/UHF/CABLE CHANNELS

Air	Cable
VHF 2-13	VHF 2-13
UHF 14-69	STD/HRC/IRC 14-36 (A) (W) 37-59 (AA) (WW) 60-85 (AAA) (ZZZ) 86-94 (86) (94) 95-99 (A-5) (A-1) 100-125 (100) (125) 01 (5A)

Note:

- If a channel with no broadcast is selected, the sound will automatically be muted.
- It may take a few seconds for a digital channel picture to appear on screen after being selected.

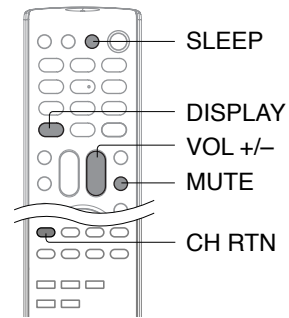

TV operation (continued)

■ DISPLAY

Press **DISPLAY** to display the current information on the screen.



When the TV/DVD receives a digital signal, the digital information will appear.

- Channel number
- Channel label (if preset)
- V-Chip rating
- Sleep timer
- Program guide
- Resolution
- Station name
- Broadcast program name
- Signal type
- Audio language
- Picture size
- Clock

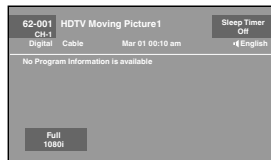

When the TV/DVD receives an analog signal, the analog information will appear.

- Channel number
- V-Chip rating
- Sleep timer
- Picture size
- Channel label (if preset)
- Signal type
- Audio information (Stereo or SAP)
- Resolution

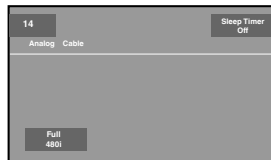

Press **DISPLAY** again to clear the call display.

Note:

- After a few seconds, DISPLAY screen will return to normal TV-operation automatically.

■ CH RTN

This button allows you to go back to the last channel selected by pressing **CH RTN**. Press **CH RTN** again to return to the last channel you were watching.



■ MUTE

Press **MUTE** to switch off the sound. The TV/DVD's sound will be silenced and "Mute" will appear on the screen. The sound can be switched back on by pressing this button again or the **VOL +** or **-**.



■ SLEEP

To set the TV/DVD to turn off after a preset amount of time, press **SLEEP** on the remote control. The clock will count up 10 minutes for each

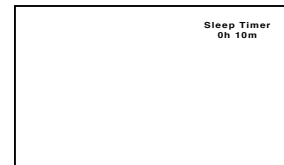

press of the **SLEEP** button (Off, 0h 10m, 0h 20m, ..., 2h 0m). After the sleep time is programmed, the display will appear briefly every ten minutes to remind you that the sleep timer is operating. To confirm the sleep timer setting, press **SLEEP** and the remaining time will be displayed for a few seconds. To cancel the sleep timer, press **SLEEP** repeatedly until the display turns to Off.

■ HEAD PHONES

Insert a stereo headphones (not supplied) with a 1/8" mini plug into the HEAD PHONE jack on the front panel. If you connect headphones, the sound from TV/DVD speakers is muted.

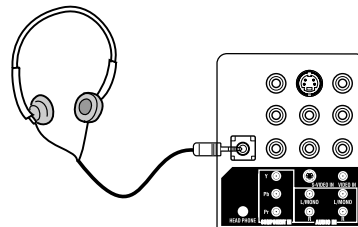

TV operation

Labeling channels

Channel label appear with the channel number display each time you turn on the TV/DVD, select a channel, or press DISPLAY.
You can choose any four characters to identify a channel.

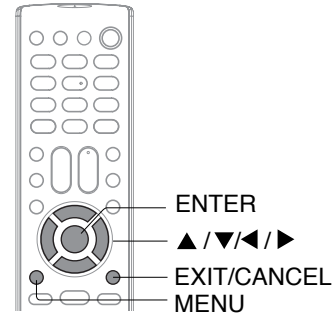

Labeling channels

- 1** Press MENU in the TV mode. The TV menu screen will appear. Press then press ▲ or ▼ to select “Channel” menu, then press ► or ENTER.

MENU
SETUP

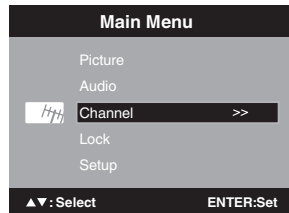
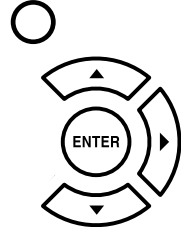

- 2** Press ▲ or ▼ to select “Ch Label”, then press ► or ENTER. The “Ch Label” menu will appear.

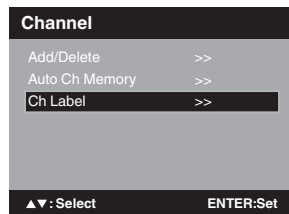
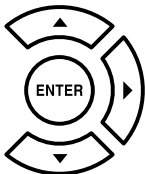

- 3** Press ◀ or ▶ to select a channel you want to label, then press ▼.

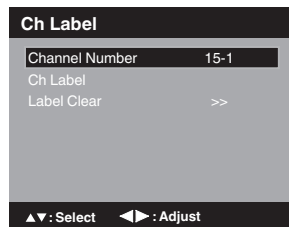
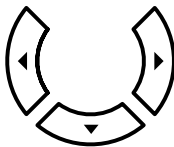

- 4** Press ◀ or ▶ repeatedly until the character you want appears in the first space.

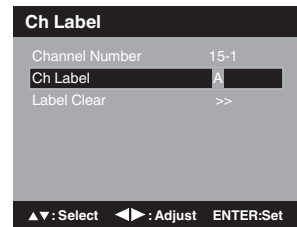
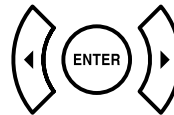

The characters rotation as follows:

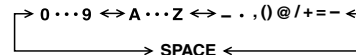

If the character which you desire appears, press **ENTER**.

Repeat this step to enter the rest of the characters.

If you would like a blank space in the label name, you must choose the empty space from the list of characters.

- 5** When you finish inputting the label name, press EXIT/CANCEL to return to the normal screen.



- 6** Repeat steps 3-5 for other channel. You can assign a label to each channel.

To clear a Ch Label

After step 3 above, press ▲ or ▼ to select “Label Clear”, then press ► or **ENTER**.

Note:

- The channel labels will be reset after “Automatic Search” on page 23.

Labeling video inputs

The Video Label feature allows you to label each input source for your TV/DVD.

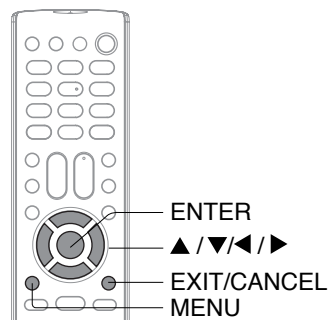

Labeling video inputs

1 Press **MENU** in the TV mode. The TV menu screen will appear. Press **▲** or **▼** to select “Setup”, then press **▶** or **ENTER**.

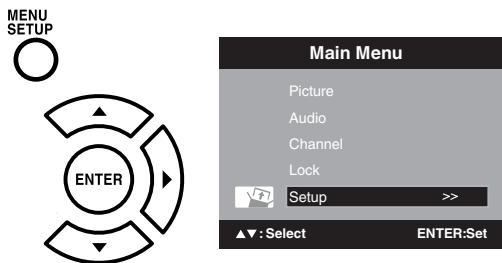

2 Press **▲** or **▼** to select “Video Label”, then press **▶** or **ENTER**.

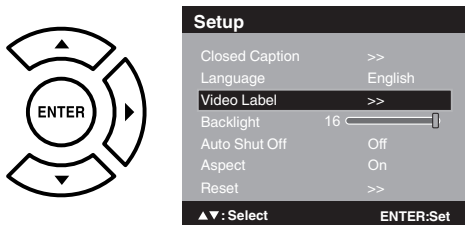

3 Press **▲** or **▼** to select an input which you want to label.

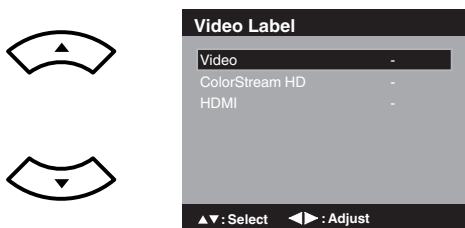

4 Press **◀** or **▶** to select the desired label for that input source.

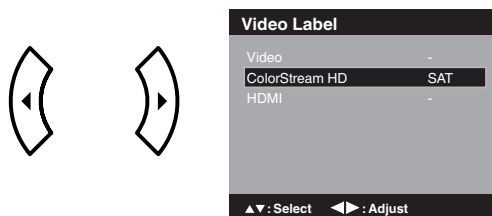

- : Uses the default label name
- VCR** : Video cassette recorder
- DVD** : DVD video
- DTV** : Digital TV set-top box
- SAT** : Satellite box
- CBL** : Cable box
- HD** : HDMI (only for HDMI input)

5 Press **EXIT/CANCEL** to return to the normal screen.



TV operation

Setting the V-Chip

An age limitation can be set to restrict children from viewing or hearing violent scenes or pictures that you may choose to exclude. The restriction applies to "TV Rating" and "Movie Rating" if this data is transmitted. You may set this restriction separately. To use the V-Chip function, you must register a password.

Notes:

If you forget the password, press **DISPLAY** four times within five seconds while the TV is in password entering mode. This allows you to reset your password.

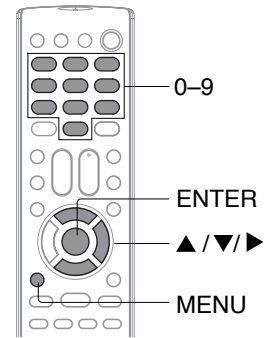

To register a password

1 Press **MENU** in the TV mode. The TV menu screen will appear. Press **▲** or **▼** to select "Lock", then press **▶** or **ENTER**.

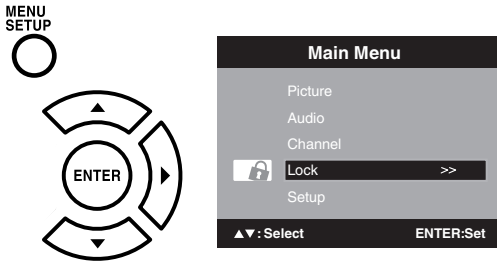

2 Select and enter your password (4 digits) using Number buttons (0-9), then press **ENTER**.

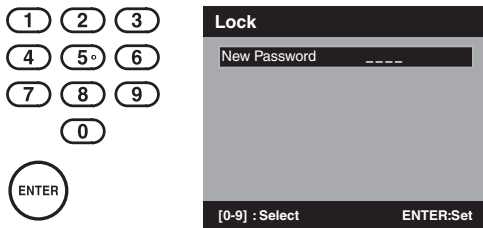

3 Enter the same password again to confirm, then press **ENTER**. The password is now registered.

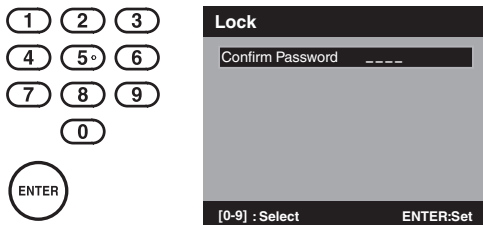

Note:

- The V-Chip feature is available only for the U.S. V-Chip system. The Canadian V-Chip system is not supported.

To change a password

1 Press **MENU** in the TV mode. The TV menu screen will appear. Press **▲** or **▼** to select "Lock", then press **▶** or **ENTER**.

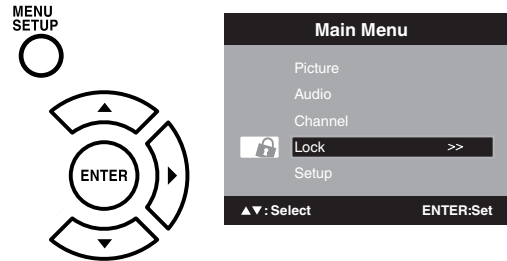

2 Press **▲** or **▼** to select "Change Password", then press **▶** or **ENTER**. The Change Password screen will appear.

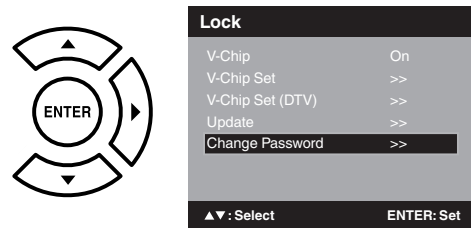

3 Enter a new password using Number buttons (0-9), then press **ENTER**.

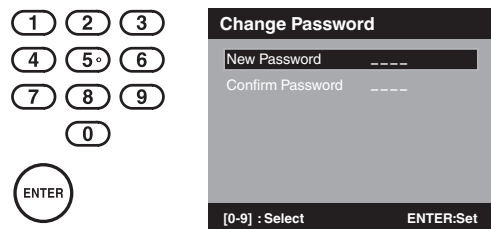

4 Enter the same password again to confirm, then press **ENTER**. The new password is now registered.

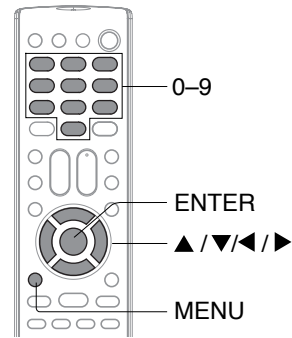

To set the V-Chip

- 1** Press MENU in the TV mode. The TV menu screen will appear. Press ▲ or ▼ to select “Lock”, then press ▶ or ENTER.

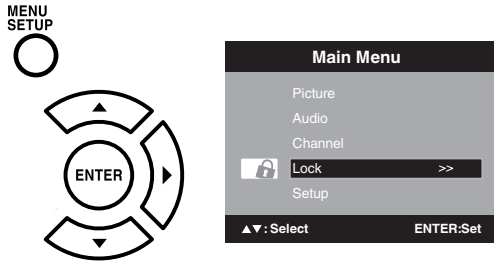

- 2** Use Number buttons (0-9) to enter your password, then press ENTER. Then Lock menu will appear.

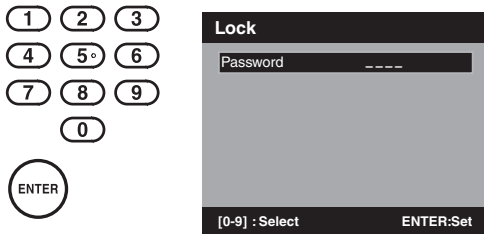

- 3** Press ▲ or ▼ to select “V-Chip”, then press ◀ or ▶ to select “On”.

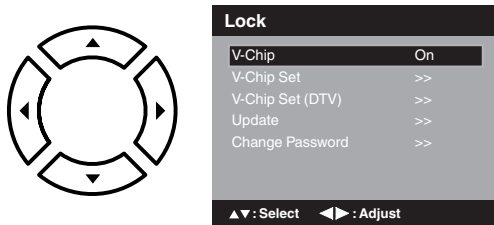

- 4** Press ▲ or ▼ to select “V-Chip Set”, then press ▶ or ENTER. The V-Chip Set Menu appears.

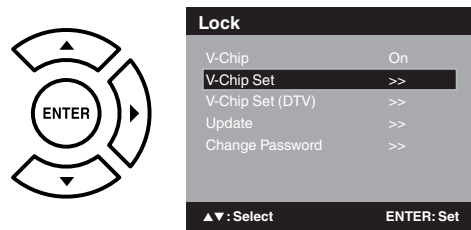

- 5** Press ▲ or ▼ to select which rating will be used, then press ▶ or ENTER. Each rating below will appear.

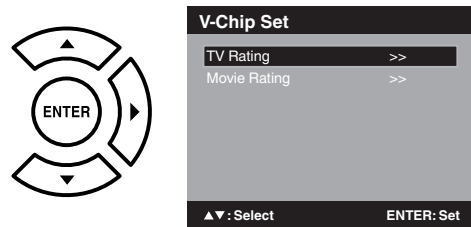

TV Rating

TV Rating	ALL	D	L	S	V	FV
TV-Y						
TV-Y7	🔒					🔒
TV-G	🔒					
TV-PG	🔒	🔒	🔒	🔒	🔒	
TV-14	🔒	🔒	🔒	🔒	🔒	🔒
TV-MA	🔒	🔒	🔒	🔒	🔒	🔒

You can set the rating using age level and genre.

- Age:**
TV-Y : All children
TV-Y7 : 7 years old and above
TV-G : General audience
TV-PG : Parental guidance
TV-14 : 14 years old and above
TV-MA : 17 years old and above
- Genre:**
ALL : All
D : Dialogue
L : Language
S : Sex
V : Violence
FV : Fantasy Violence

TV operation

Setting the V-Chip (continued)

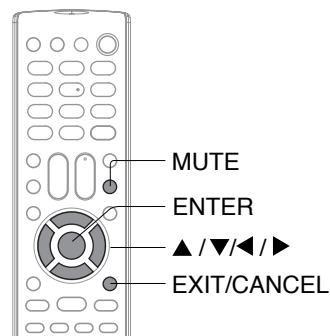

To set the V-Chip (Continued)

Movie Rating

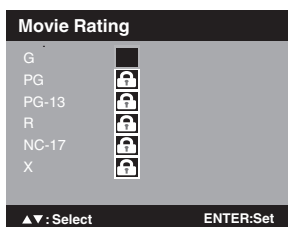

- G** : All ages
PG : Parental guidance
PG-13 : Parental guidance less than 13 years old
R : Under 17 years old parental guidance suggested
NC-17 : 17 years old and above
X : Adult only

6 Press ▲/▼/◀/▶ to select the desired rating, then press ENTER.

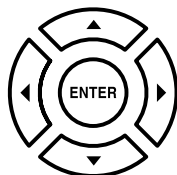

7 Press EXIT/CANCEL to return to the normal screen.



To use the TV/DVD after it is protected.

When a program is received that is blocked by the V-Chip, press **MUTE**, then enter your password. The protection will be temporarily overridden. If the TV/DVD is turned off or the channel is changed, the V-Chip restriction will be reactivated.

Note:

- The V-Chip function is activated only on programs and input sources that include a rating signal.

As a supplement to the standard V-Chip rating system, your television will be able to download an additional rating system, if such a system becomes available in the future.

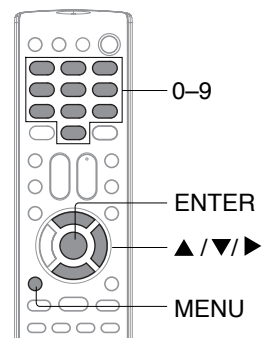

To download the additional V-Chip rating system (when available)

- 1** Press MENU in the TV mode. The TV menu screen will appear. Press ▲ or ▼ to select “Lock”, then press ► or ENTER.

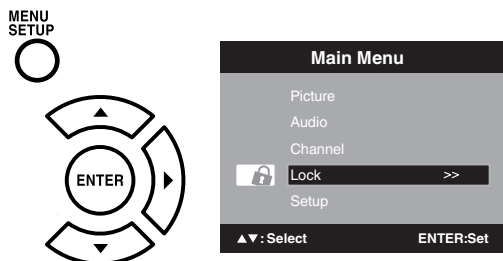

- 2** Use Number buttons (0-9) to enter your password, then press ENTER. Then Lock menu will appear.

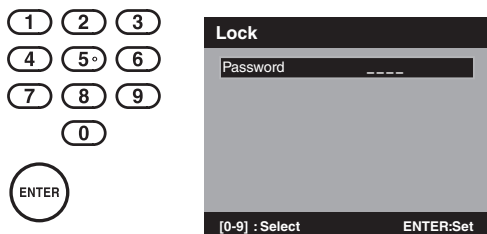

- 3** Press ▲ or ▼ to select “V-Chip Set (DTV)”, then press ► or ENTER.

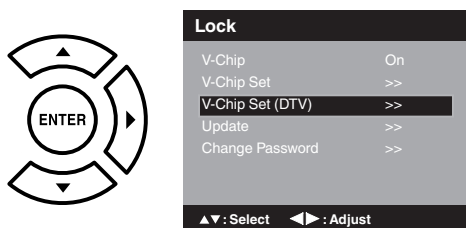

- 4** If the TV/DVD is not storing the additional rating system, the TV/DVD will begin downloading it, which may take some time to be completed.

- 5** Set your preferred content rating limits for the additional rating system.

- 6** You also need “Update” procedure to update rating information.

Note:

- You can only download the additional V-Chip rating system when your TV/DVD is receiving a digital signal.
- When you download the additional rating system, it may take some time for the download to occur.
- The V-Chip rating information and system are not determined or controlled by the TV/DVD.
- The standard V-Chip rating system is available whether your TV/DVD is receiving a digital signal or not, and will block both analog and digital programs. To set the restriction level using the standard V-Chip rating system, select “V-Chip Set” in step 3.
- The downloadable V-Chip rating system is an evolving technology, and availability, content, and format may vary.
- You cannot select this feature if the TV/DVD is not receiving a digital signal for the current station.

TV operation

Setting the closed captions

WHAT IS CLOSED CAPTIONING?

This television has the capability to decode and display closed captioned television programs. Closed captioning will display text on the screen for hearing impaired viewers or it will translate and display text in another language.

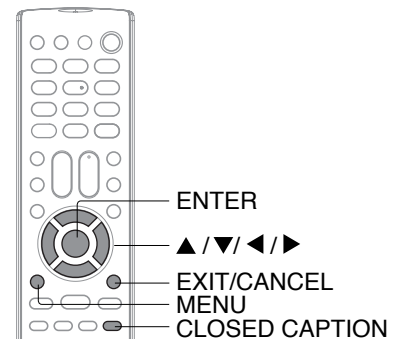

Setting the closed captions

- 1** Press **MENU** in the TV mode. Press **▲** or **▼** to select **“Setup”**, then press **▶** or **ENTER**.

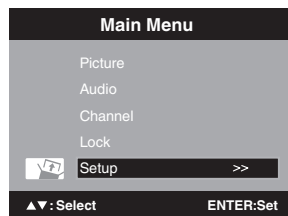
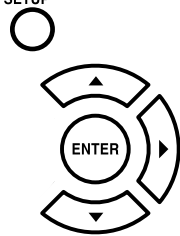
MENU
SETUP

- 2** Press **▲** or **▼** to select **“Closed Caption”**, then press **▶** or **ENTER**. The Closed Caption menu will appear.

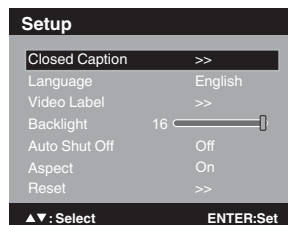
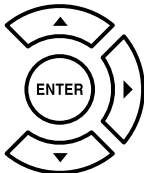

- 3** Press **▲** or **▼** to select **“CC Setting”**, then press **◀** or **▶** to select **“On”**.
On: Captions will be displayed on the screen.
Off: Captions will not be displayed on the screen.

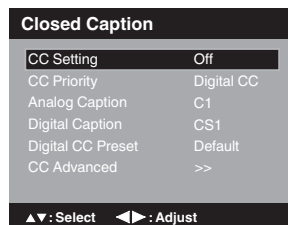
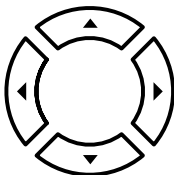

- 4** Press **▲** or **▼** to select **“Analog Caption”** or **“Digital Caption”**, then press **◀** or **▶** to select the desired Closed Caption mode.

When you select **“Analog Caption”**, you can choose C1, C2, C3, C4, T1, T2, T3 and T4.

When you select **“Digital Caption”**, you can choose from CS1, CS2, CS3, CS4, CS5 and CS6.

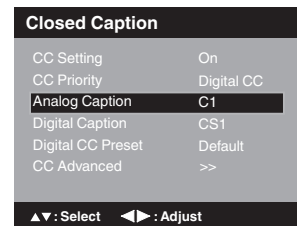
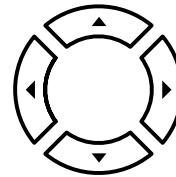

- 5** Press **▲** or **▼** to select **“CC Priority”**, then press **◀** or **▶** to select **“Digital CC”** or **“Analog CC”**.

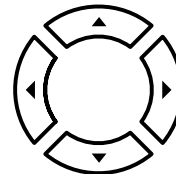

Note:

- Depending on the broadcast signal, some Analog Captions will function with a Digital broadcast signal. This step prevent that two kind of captions are overlapping.

- 6** Press **EXIT/CANCEL** to return to the normal screen.



Note:

- You can also display the Closed Caption menu screen by pressing **CLOSED CAPTION** on the remote control.
- Digital caption feature is not available for analog channel.

Important Note:

If text is not available in your viewing area, a black rectangle may appear on-screen. If this happens, set **“CC Setting”** to **“Off”**.

CC advanced

When you have selected Custom as the display method, you can adjust the various setting listed below as follows:

This feature is designed to customize Digital Captions only.

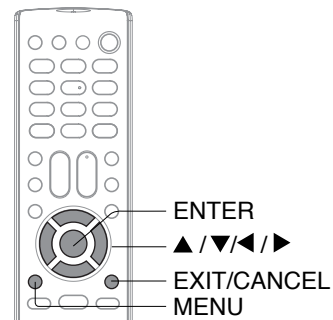

CC advanced

- 1** Press MENU in the TV mode. Press ▲ or ▼ to select "Setup", then press ► or ENTER.

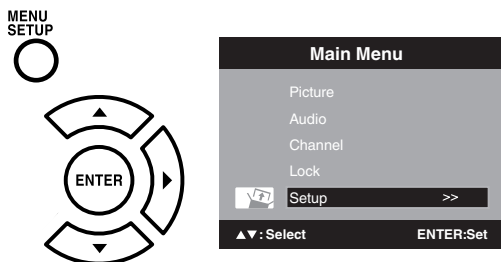

- 2** Press ▲ or ▼ to select "Closed Caption", then press ► or ENTER. The Closed Caption menu will appear.

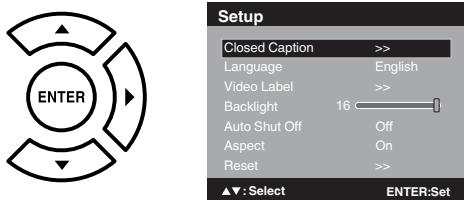

- 3** Press ▲ or ▼ to select "Digital CC Preset", then press ◀ or ▶ to select "Custom".

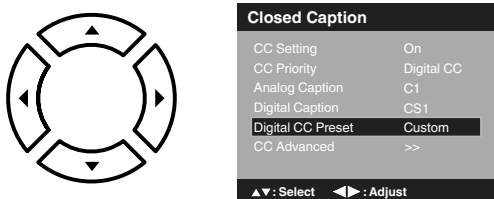

- 4** Press ▲ or ▼ to select "CC Advanced", then press ► or ENTER. The CC Advanced menu will appear.

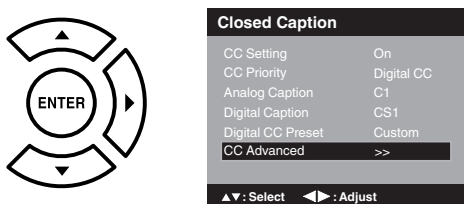

- 5** Press ▲ or ▼ to select the desired item, then press ◀ or ▶ to change the setting.

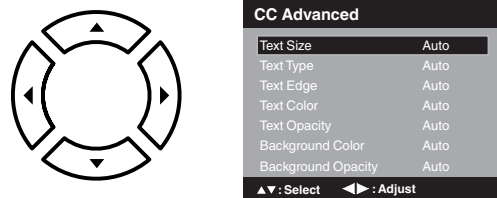

You can select from among the following items and parameters.

- Text Size:** Auto, Small, Standard, Large
Text Type: Auto, Style1, Style2, Style3, Style4, Style5, Style6, Style7
Text Edge: Auto, None, Raised, Depressed, Uniform, Left Shadow, Right Shadow
Text Color: Auto, Black, White, Red, Green, Blue, Yellow, Magenta, Cyan
Text Opacity: Auto, Transparent, Translucent, Solid, Flashing
Background Color: Auto, Black, White, Red, Green, Blue, Yellow, Magenta, Cyan
Background Opacity: Auto, Transparent, Translucent, Solid, Flashing

- 6** Press EXIT/CANCEL to return to the normal screen.



Note:

- You cannot select "CC Advanced" in the menu before set "Digital CC preset" to "Custom".
- You cannot set the Closed Caption "Text Color" and "Background Color" as the same color.

Adjusting the picture preference/ Picture settings

You can select four picture modes—Sports, Standard, Movie and Memory—as described in the following table:

Picture settings are factory preset but you can adjust them individually as follows:

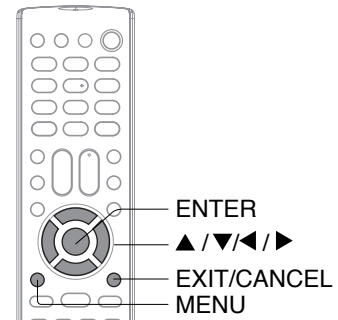

Adjusting the picture preference

1 Press MENU in the TV mode. The TV menu screen will appear. Press ▲ or ▼ to select “Picture”, then press ► or ENTER.

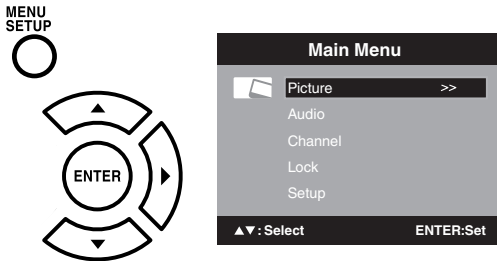

2 Press ▲ or ▼ to select “Picture Preference”.

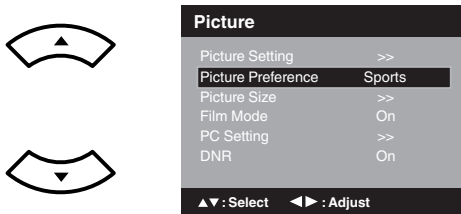

3 Press ◀ or ▶ to select a mode you want to adjust.

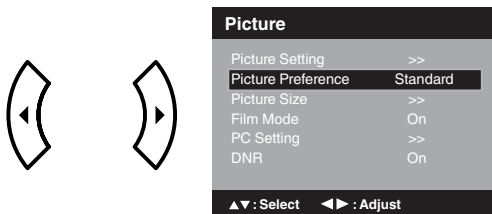

Mode	Picture Quality
Sports	Bright and dynamic picture (factory-set)
Standard	Standard picture quality (factory-set)
Movie	Movie-like picture setting (factory-set)
Memory	Your personal preferences (set by you; see “Picture settings” at right).

4 After your desired setting, press EXIT/ CANCEL to return to the normal screen.

Picture settings

1 Press MENU in the TV mode. The TV menu screen will appear. Press ▲ or ▼ to select “Picture”, then press ► or ENTER.

2 Press ▲ or ▼ to select “Picture Setting”.

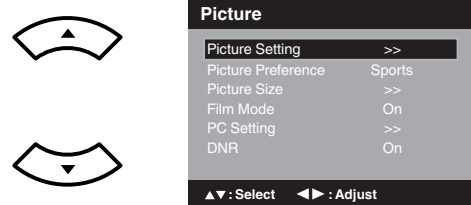

3 Press ▲ or ▼ to select the item you want to adjust. Press ◀ or ▶ to adjust the setting.

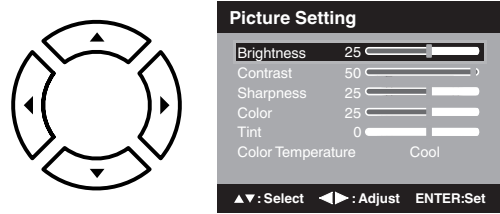

	◀	▶
Brightness	decrease brightness	increase brightness
Contrast	decrease contrast	increase contrast
Sharpness	makes picture softer	makes picture clearer
Color	be pale color	be brilliant color
Tint	be reddish color	be greenish color

Color Temperature	Picture Quality
Cool	Bluish
Standard	Neutral
Warm	Reddish

5 After your desired setting, press EXIT/ CANCEL to return to the normal screen.

Note:

- The Contrast default setting is set to maximum at the factory.

Viewing the wide-screen picture formats

You can view programs in a variety of picture sizes— Natural, Theater Wide1, Theater Wide2, Theater Wide3 and Full.

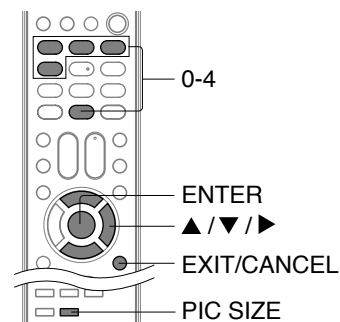

Viewing the wide-screen picture formats

1 Press MENU. Press ▲ or ▼ to select “Picture”, then press ▶ or ENTER.

2 Press ▲ or ▼ to select “Picture Size”, then press ▶ or ENTER to display Picture Size menu. Press ▲/▼ or corresponding Number button (0-4) to select the desired picture size, as described below and on the next page.

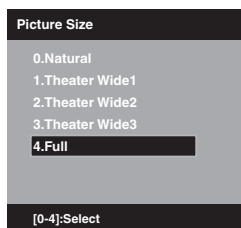

Note:

- Selectable picture sizes may vary depending on the input source or broadcast signal.
- Picture Size menu also can be displayed by pressing **PIC SIZE** on the remote control.

3 Press EXIT/CANCEL to return to the normal screen.

Natural picture size

In some cases, this image will display the size of standard 4:3 with a gray side bar.

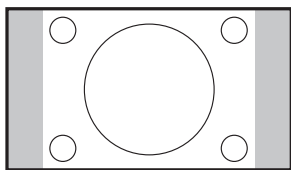

Theater Wide1 picture size (for 4:3 format programs)

To fill the screen, the right and left edges are extended, however; the center of the picture remains near its former ratio. The top and bottom edges of the picture may be hidden.

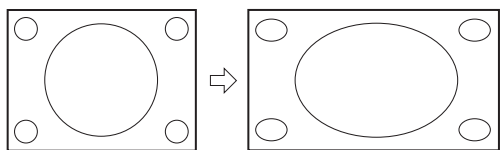

Theater Wide2 picture size (for letter box programs)

The entire picture is uniformly enlarged—it is stretched the same amount both wider and taller (retains its original proportion).

The top and bottom edges of the picture may be hidden.

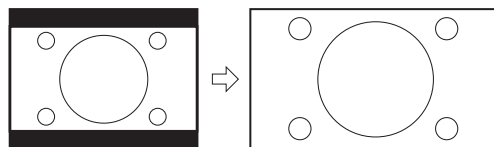

Note:

- This picture size is not available on 22LV505.

Theater Wide3 picture size (for letter box programs with subtitles)

To fill the width of the screen, it is extended horizontally. However; it is only slightly extended at the top and the bottom.

The top and bottom edges of the picture may be hidden.

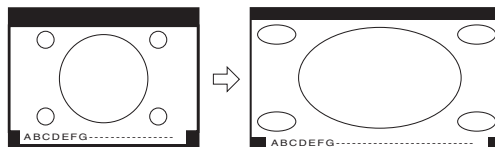

Note:

- To select this picture size on 22LV505, select “Theater Wide2”.

Full picture size (for 16:9 source programs)

Full will display the picture at the maximum size.

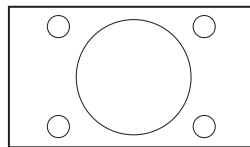

Note:

- Some High Definition and/or Digital broadcasts may not allow you to change the picture size.
- 19LV505/19LV506: In COMPONENT/HDMI mode with a scanning rate of 720p or 1080i, only the Theater Wide2 and Full picture size features are available.
- 22LV505: In COMPONENT/HDMI mode with a scanning rate of 720p or 1080i, picture size feature will not work.
- In PC Mode, only the Natural and Full picture size features are available. Additionally this feature will not work when display mode is WXGA.

TV operation

Film Mode/DNR

A smoother motion may be obtained by setting the Film Mode to "On" when you view a DVD.

DNR (Digital Noise Reduction) can reduce the roughness of the picture. (This function is available only for analog broadcast.)

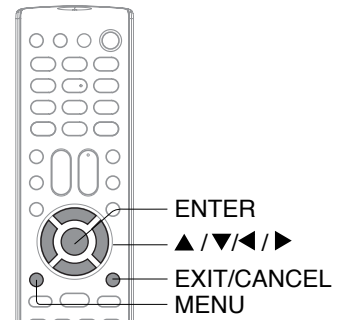

Film Mode

- 1 Press MENU in the TV mode. The TV menu screen will appear. Press ▲ or ▼ to select "Picture", then press ▶ or ENTER.

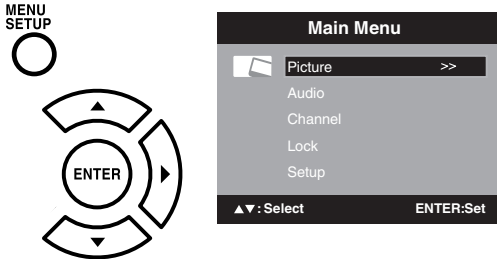

- 2 Press ▲ or ▼ to select "Film Mode".

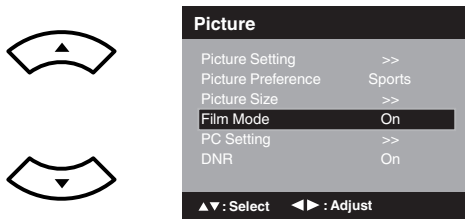

- 3 Press ◀ or ▶ to select "On" or "Off".

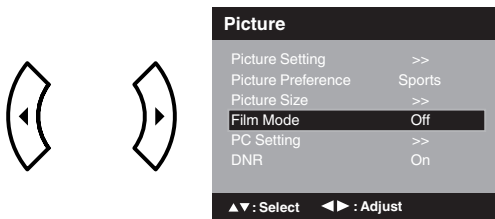

- 4 Press EXIT/CANCEL to return to the normal screen.



DNR

Note:

- The PC settings are not effective for other input modes.

- 1 Press MENU in the TV mode. Then press ▲ or ▼ to select "Picture", then press ▶ or ENTER.

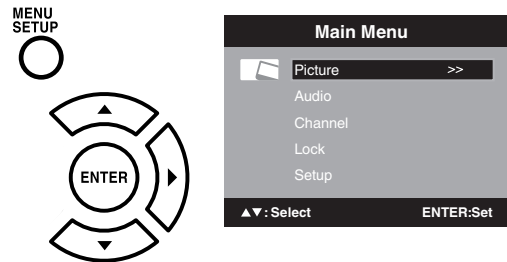

- 2 Press ▲ or ▼ to select "DNR".

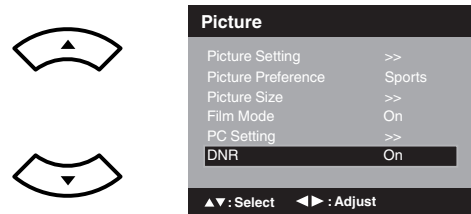

- 3 Press ◀ or ▶ to select "On" or "Off".

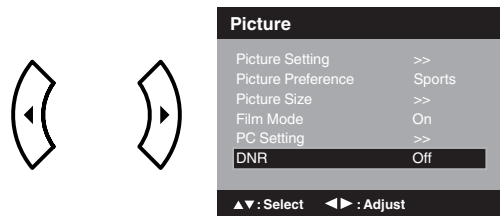

Note:

- A smoother motion may be obtained by setting the Film Mode to "On" when you view a DVD from the DVD player connected with ColorStream (component video) inputs.

Picture control adjustment in the PC mode

You can adjust to optimize the performance of the TV/DVD in the PC mode.

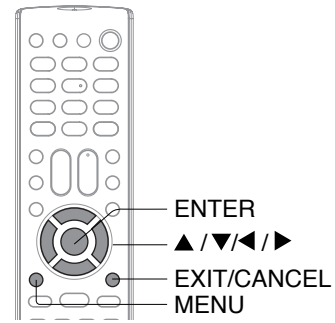

Picture control adjustment in the PC mode

1 Press INPUT, then press ▲/▼ or 4 to select the PC mode.

2 Press MENU. Then press ▲ or ▼ to select "Picture", then press ► or ENTER.

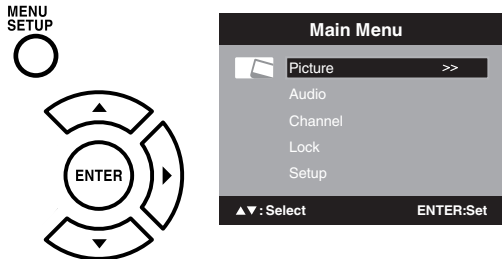

3 Press ▲ or ▼ to select "PC Setting", then press ► or ENTER.

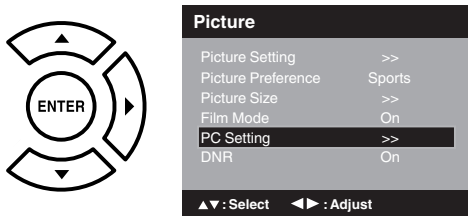

4 Press ▲ or ▼ to select the desired item you want to adjust.

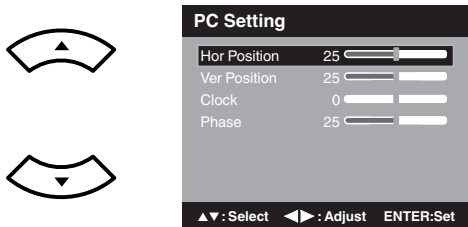

5 Press ◀ or ▶ to adjust the setting.

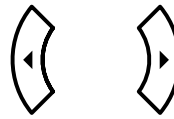

Hor Position: To adjust the horizontal position of the image on the PC mode.

Ver Position: To adjust the vertical position of the image on the PC mode.

Clock: To minimize any vertical bars or stripes visible on the screen background.

Phase: This must be adjusted after the frequency of the PC mode has been set to 60Hz to optimize picture quality (page 14).

6 After adjusting, press ENTER to return to the PC Setting menu. Then continue to adjust the other items.



7 Press EXIT/CANCEL to return to the normal screen.



TV operation

Sound control adjustment/ Selecting Stereo/Second Audio Program (SAP)

The multi-channel TV sound (MTS) feature provides high-fidelity stereo sound. MTS also can transmit a second audio program (SAP) containing a second language or other audio information. When the TV/DVD receives a stereo or SAP broadcast, the word "Stereo" or "SAP" displays on-screen every time you press DISPLAY.

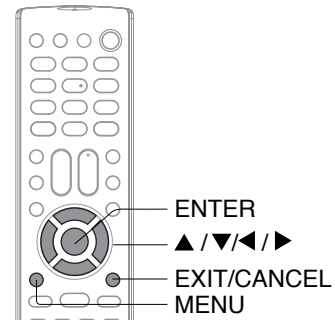

Sound control adjustment

- 1 Press MENU in the TV mode. The TV menu screen will appear. Press ▲ or ▼ to select "Audio", then press ► or ENTER.

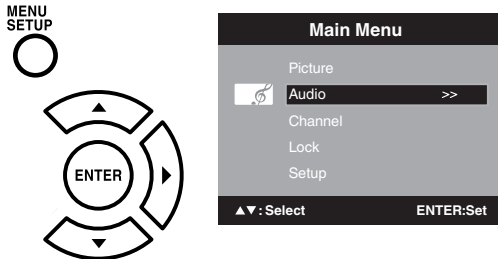

- 2 Press ▲ or ▼ to select the item you want to adjust. Then press ◀ or ▶ to adjust each setting.

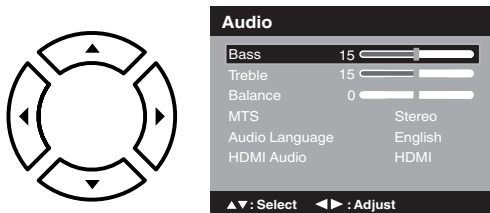

- Bass:** Press ◀ or ▶ to adjust the bass sound.
Treble: Press ◀ or ▶ to adjust the treble sound.
Balance: Press ◀ or ▶ to obtain an equal sound level from both speakers.

- 3 After you desired setting, press EXIT/CANCEL to return to the normal screen.



Selecting Stereo/Second Audio Program (SAP)

- 1 Press MENU in the TV mode. Press ▲ or ▼ to select "Audio", then press ► or ENTER.

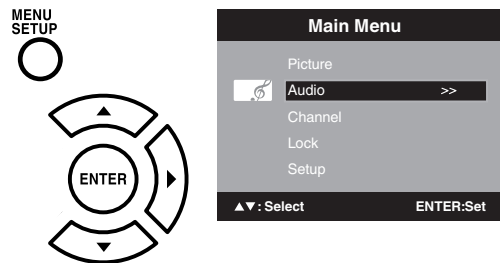

- 2 Press ▲ or ▼ to select "MTS", then press ◀ or ▶ to select "Stereo".

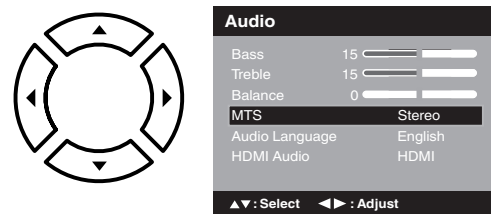

- 3 Press EXIT/CANCEL to return to the normal screen.



Note:

- Generally you can leave your TV in stereo mode because the TV automatically outputs the type of sound being broadcast (stereo or mono).
- If the stereo sound is noisy, select "Mono" to reduce the noise.

To listen to a second audio program (SAP)

Press ◀ or ▶ to select "SAP" in step 2 above. The TV speakers will output the second audio program instead of normal audio.

Selecting the audio language/ Selecting the HDMI audio input source

When two or more audio languages are included in a digital signal, you can select one of the audio language. (This function is available only for digital broadcast.)

When you use PC AUDIO IN jacks with HDMI or DVI device, you must select HDMI audio input source from "HDMI" or "DVI".

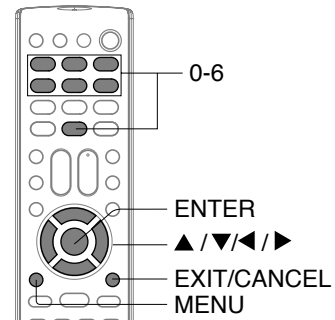

Selecting the audio language

- 1 Press **MENU** in the TV mode. Then press **▲** or **▼** to select "Audio", then press **▶** or **ENTER**.

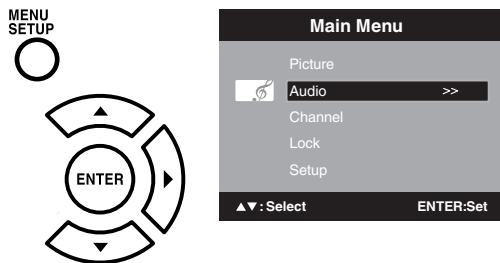

- 2 Press **▲** or **▼** to select "Audio Language", then press **▶** or **ENTER** to display the Audio Language menu.

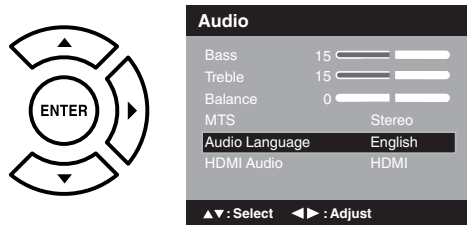

- 3 Press **▲/▼** or **Number buttons (0-6)** to select your desired language.

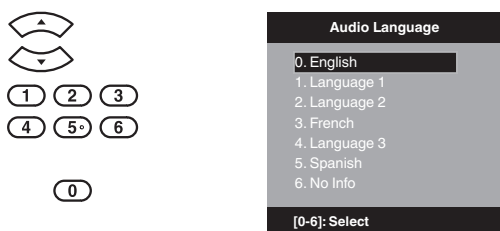

- 4 After you desired setting, press **EXIT/CANCEL** to return to the normal screen.



Selecting the HDMI audio input source

- 1 Press **MENU** in the TV mode. The TV menu screen will appear. Press **▲** or **▼** to select "Audio", then press **▶** or **ENTER**.

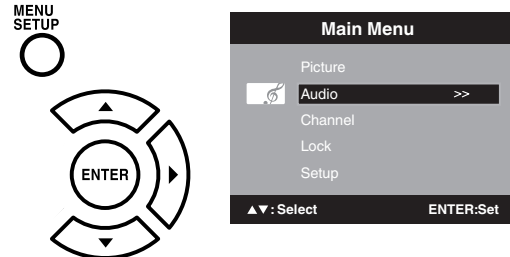

- 2 Press **▲** or **▼** to select "HDMI Audio". Then press **◀** or **▶** to select "HDMI" or "DVI".

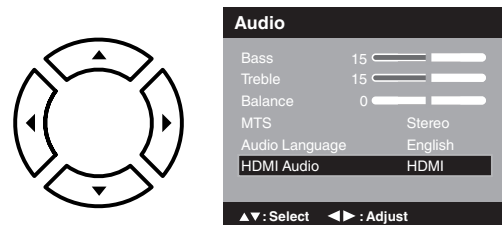

HDMI: When you connect the HDMI device to the TV, select this setting.

DVI: When you connect the DVI device to the TV with analog audio cords, select this setting.

- 3 Press **EXIT/CANCEL** to return to the normal screen.



TV operation

Using the aspect feature/ Adjusting the back lighting

When the Aspect feature is set to On and the TV receives a 480i signal, the picture size is automatically selected (as described in the following table).

The Backlight feature adjusts the screen brightness for improved picture clarity.

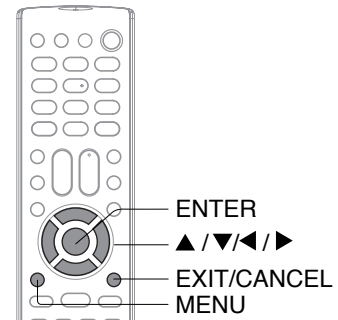

Using the aspect feature

- 1 Press MENU in the TV mode. The TV menu screen will appear. Press ▲ or ▼ to select "Setup", then press ► or ENTER.

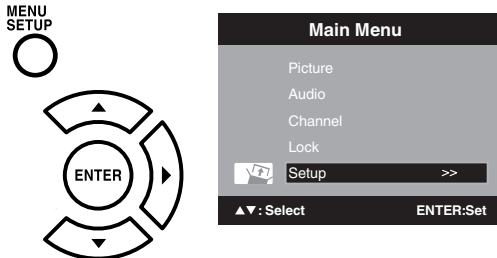

- 2 Press ▲ or ▼ to select "Aspect". Press ◀ or ▶ to select "On" or "Off".

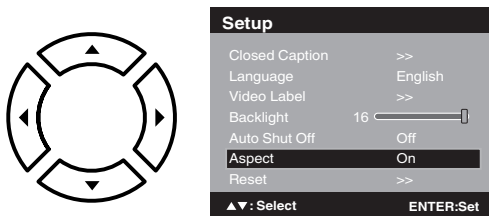

- 3 After you desired setting, press EXIT/CANCEL to return to the normal screen.



Aspect ratio of signal source	Automatic aspect size (When Aspect is On)
4:3 Normal	Natural
16:9 Full	Full
4:3 Letter box	Theater Wide2
Not defined	User-set mode

Adjusting the back lighting

- 1 Press MENU in the TV mode. The TV menu screen will appear. Press ▲ or ▼ to select "Setup", then press ► or ENTER.

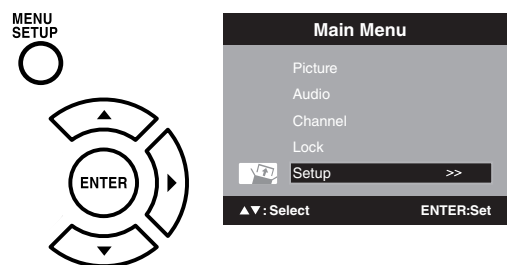

- 2 Press ▲ or ▼ to select "Backlight".

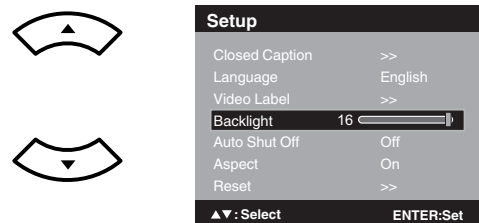

- 3 Press ◀ or ▶ to adjust the setting.

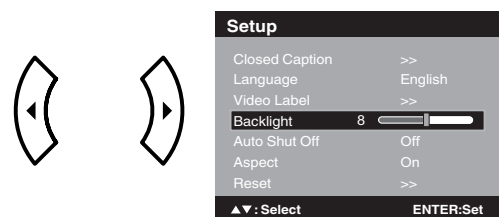

- 4 After you desired setting, press EXIT/CANCEL to return to the normal screen.



Setting the Auto Shut Off/ Resetting your settings

If the Auto Shut Off feature is On, a station being viewed stops broadcasting and the TV is not operated, the TV will automatically shut itself off after 15 minutes.

The Reset function returns your settings to the factory settings.

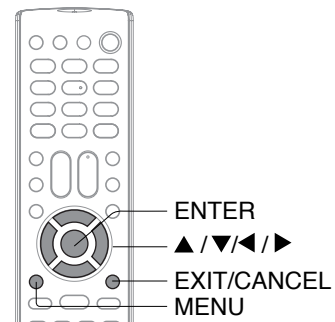

Setting the Auto Shut Off

1 Press MENU in the TV mode. The TV menu screen will appear. Press ▲ or ▼ to select "Setup", then press ► or ENTER.

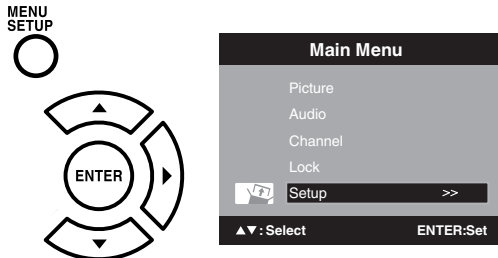

2 Press ▲ or ▼ to select "Auto Shut Off". Press ◀ or ▶ to select "On" or "Off".

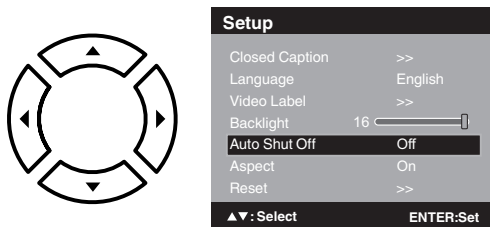

3 After you desired setting, press EXIT/CANCEL to return to the normal screen.



Resetting your settings

1 Press MENU in the TV mode. The TV menu screen will appear. Press ▲ or ▼ to select "Setup", then press ► or ENTER.

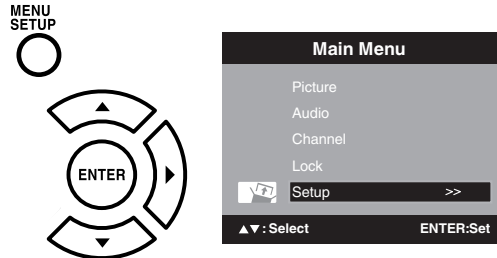

2 Press ▲ or ▼ to select "Reset".

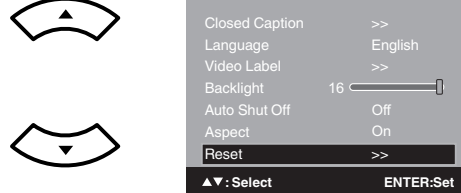

3 Press ► or ENTER to return your settings to the factory settings.



4 "Reset" will appear on the screen approx. 3 seconds, then it returns to the normal

TV operation

Note:

- The Reset function returns your picture quality adjustments to the following factory settings:

Picture Setting	Audio
Brightness..... center (25)	Bass..... center (15)
Contrast max (50)	Treble..... center (15)
Sharpness..... center (25)	Balance..... center (0)
Color center (25)	Film Mode.....On
Tint..... center (0)	PC Setting
Color Temperature... Cool	Hor Position ... center (25)
Picture Preference.... Sports	Ver Position.... center (25)
	Clock..... center (0)
	Phase..... center (25)

Playing a disc

This section shows you the basics on how to play a disc.

CAUTION

Keep your fingers well clear of the disc slot when disc is loading or unloading. Neglecting to do so may cause serious personal injury.

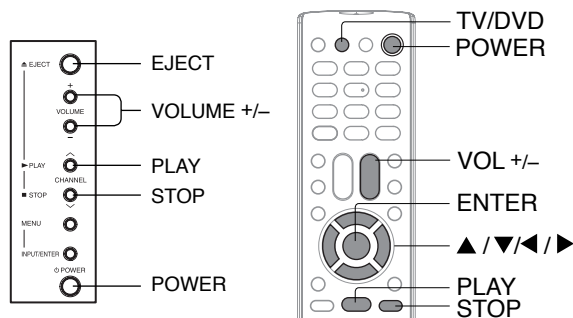

DVD VCD CD Basic playback

Preparations:

- When connecting to other equipment, turn the power off.

1 Press POWER on the unit or on the remote control to turn on the unit.

- POWER indicator on the front of the unit changes green. It may take approx. 10 seconds for a picture to appear on screen.
- Every time you press **POWER**, the TV/DVD starts from TV mode.
- When using an amplifier, switch on the amplifier.



2 Press TV/DVD on the remote control to select DVD mode.

The DVD startup screen will appear on the TV screen.



3 Load a disc in the disc slot.

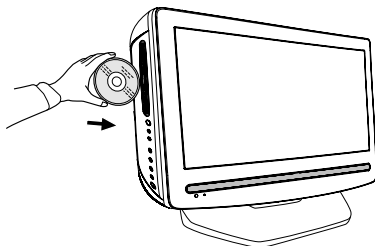

- Load the disc in the disc slot with the label side facing forward. (If the disc has a label.) Hold the disc without touching either of its surfaces, align it with the guides, and place it in position.
- If a disc is inserted during some modes other than DVD mode, it may switch to DVD mode and then playback may be begun automatically.

4 On the TV screen, "▲" changes to "Reading" and then playback commences.



A menu screen will appear on the TV screen if the disc has a menu feature.

Press ▲ / ▼ or ◀ / ▶ on the remote control to select title, then press **ENTER**. Title is selected and play commences.

5 Press VOLUME + or - to adjust the volume.



6 Press STOP to end playback.

- **Resuming facility**
 - The unit records the stopped point, depending on the disc. "■" appears on the screen. Press **PLAY** to resume playback (from the scene point).
 - If you press **STOP** again ("■" appears on the TV screen.), the unit will clear the stopped point.

■ To start playback in the stop mode

Press **PLAY**.



Note:



If the unit does not operate properly:

Static electricity, etc., may affect the TV/DVD's operation. In such case, disconnect the AC cord, then connect it again.

■ To obtain a higher quality picture

Occasionally, some picture noise may appear on the TV screen while playing a DVD video disc because the high resolution pictures on these discs include a lot of information. In such case, you may reduce the Sharpness with the Picture Setting menu (see page 36).

■ About

The    icons on the heading bar show the playable discs for the function described under that heading.

 : You can use this function with DVD video discs.

 : You can use this function with Video CDs.

 : You can use this function with Audio CDs and CD-R/RW CDs.

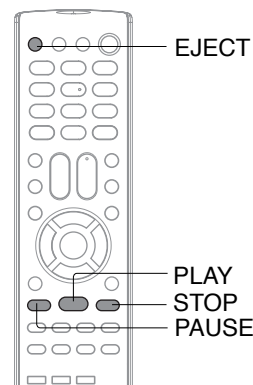

Basic playback (continued)

■ To pause playback (still mode)

Press **PAUSE** during playback.

PAUSE



To resume normal playback, press **PLAY**.



- The sound is muted during still mode.

■ To stop playback

Press **STOP**.

STOP



■ To remove the disc

Press **EJECT**.

Remove the disc after the disc comes out.

▲ EJECT

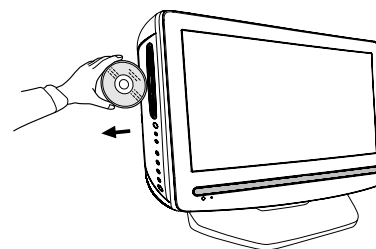

Note:

- If a non-compatible disc is loaded, "Incorrect Disc", "Region Code Error" or "Parental Error" will appear on the TV screen according to the type of loaded disc. In this case, check your disc again (see pages 7 and 64).
- Some discs may take a minute or so to start playback.
- When you set a single-faced disc label downwards (ie. the wrong way up), "Reading" will appear on the display for a few minutes and then "Incorrect Disc" will continue to be displayed.
- Some discs may not work the resuming facility.
- Resuming cannot function when you play a PBC-featured Video CD while the PBC is on. To turn off the PBC, see page 53.
- Some playback operations of DVDs may be intentionally fixed by software producers. Since this unit plays DVDs according to the disc contents the software producers designed, some playback features may not be available. Also refer to the instructions supplied with the DVDs.
- Do not move the unit during playback. Doing so may damage the disc.
- Use the **EJECT** to unload and eject the disc.
- Do not put any objects other than discs on the disc slot. Doing so may cause the unit to malfunction.
- In many instances, a menu screen will appear after playback of a movie is completed. Prolonged display of an on-screen menu may damage your television set, permanently etching that image onto its screen. To avoid this, be sure to press **POWER** on the remote control once the movie is completed.
- There may be a slight delay between the button is pressed and the function activates.

Playing a disc (Continued)

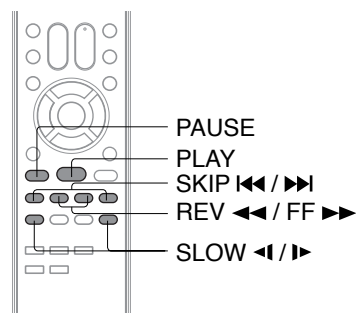

DVD VCD CD Playing in fast reverse or fast forward directions

Press **REV** or **FF** during playback.



REV: Fast reverse playback
FF: Fast forward playback

Each time you press **REV** or **FF** button, the playback speed changes.

To resume normal playback

Press **PLAY**.



Note:

- The TV/DVD mutes sound during reverse and forward scan of DVD/VCD/Audio CD discs.
- The playback speed may differ depending on the disc.
- You can use fast reverse/fast forward playback for DivX® CD.

DVD VCD Playing frame by frame

Press **PAUSE** during still playback.



Each time you press **PAUSE**, the picture advances one frame.

To resume normal playback

Press **PLAY**.



Note:

- The sound is muted during frame by frame playback.
- You can use frame by frame playback for DivX® CD.

DVD VCD Playing in slow-motion

Press **SLOW ◀◀ (REVERSE)** or **▶▶ (FORWARD)** during playback.



Each time you press the button, the slow-motion speed changes.

To resume normal playback

Press **PLAY**.



Note:

- The sound is muted during slow-motion playback.
- The Video CD cannot play Reverse Slow.

DVD VCD CD Locating a chapter or track

Press **SKIP ◀◀** or **▶▶** repeatedly to display the chapter or track number you want.

Playback starts from the selected chapter or track.



To locate succeeding chapters or tracks.



Playback starts from the beginning of the current chapter or track. When you press twice in quick successions, playback starts from the beginning of the preceding chapter or track.

Note:

- A "Prohibition" symbol "X" may appear at the upper right of the screen. This symbol means either the feature you tried is not available on the disc, or the TV/DVD cannot access the feature at this time. This does not indicate a problem with the TV/DVD.

Zooming/Locating desired scene

This unit will allow you to zoom in on the frame image. You can then make selections by switching the position of the frame.

Use the title, chapter and time recorded on the DVD disc to locate the desired point to playback. In the case of VCD/Audio CD discs, time and track are used to locate the desired point to playback.

To check the title/track, chapter/track and time, press **DISPLAY**.

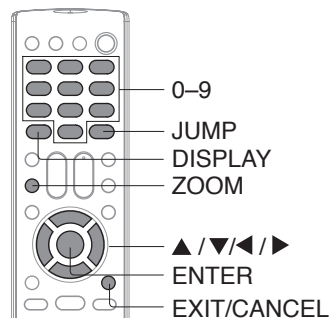

DVD VCD CD Zooming

1 Press ZOOM during playback.



The center part of the image will be zoomed in.

Each press of **ZOOM** will change the ZOOM \mathcal{Q}_1 (x 1.3), \mathcal{Q}_2 (x 1.5) and \mathcal{Q}_3 (x 2.0).

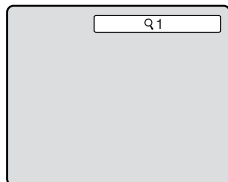

2 Press $\blacktriangle/\blacktriangledown/\blacktriangleleft/\blacktriangleright$ to view a different part of the frame.



You may move the frame from the center position to UP, DOWN, LEFT or RIGHT direction.

3 In the zoom mode, press ZOOM repeatedly to return to a 1:1 view (\mathcal{Q} Off).



Note:

- You can select the Pause, Slow or Search playback in the zoom mode.
- Some discs may not respond to zoom feature.
- Zoom function can be used for DivX® CD.

DVD VCD CD Locating desired scene

1 Press JUMP during playback or resume stop mode.

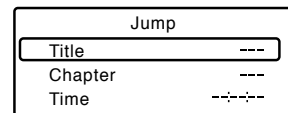

2 Press \blacktriangle or \blacktriangledown to select the "Title/Track", "Chapter" or "Time".

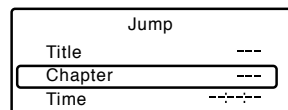

3 Press Number buttons (0-9) to input the number.

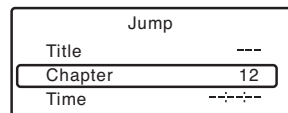
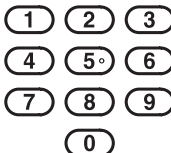

- If you input a wrong number, press **EXIT/CANCEL**.
- Refer to the package supplied with the disc to check the numbers.

4 Press ENTER. Playback starts.



- When you change the title, playback starts from Chapter 1 of the selected title.
- Some discs may not work in the above operation.

Note:

- In case of the Audio CD and Video-CD, only Track and Time can be selected.
- In case of the Video-CD playback with PBC, the JUMP does not work. To turn off PBC, see page 53.
- Only Time search function can be used for DivX® CD.

Marking desired scenes

The unit stores the points that you want to watch again up to 3 points. You can resume playback from each scene.

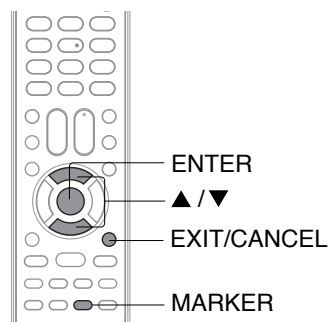

DVD VCD Marking the scenes

1 Press **MARKER** during playback.

MARKER

Marker1	-- : -- : --
Marker2	-- : -- : --
Marker3	-- : -- : --

2 Select the blank Marker using **▲** or **▼**. Then press **ENTER** to mark the desired scene.

• Repeat this procedure to mark the other 2 scenes.

ENTER

Marker1	00 : 27 : 54
Marker2	-- : -- : --
Marker3	-- : -- : --

3 Press **MARKER** to clear the display.

MARKER

DVD VCD Returning to the scenes

1 Press **MARKER** during playback or stop mode.

MARKER

Marker1	00 : 27 : 54
Marker2	01 : 16 : 25
Marker3	02 : 08 : 31

2 Press **▲** or **▼** to select the Marker 1-3.

▲

Marker1	00 : 27 : 54
Marker2	01 : 16 : 25
Marker3	02 : 08 : 31

▼

3 Press **ENTER**.

ENTER

Playback starts from the marked scene.

Note:

- Some discs may not work with the marking operation.
- The marking is cancelled when you eject the disc or turn the power off.
- Some subtitles recorded around the marker may fail to appear.
- In case of Video CD with PBC, Marker function is prohibited.

■ **To cancel the Marker**

Follow the above steps 1~2, then press **EXIT/CANCEL**.

Repeat playback/A-B Repeat playback

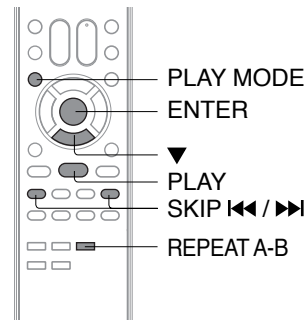

DVD VCD Repeat playback

- 1 Press PLAY MODE during playback or stop mode.**

PLAY MODE
- 2 [DVD] Press ENTER repeatedly to select "Chapter" or "Title".**

The unit automatically starts repeat playback after finishing the current title or chapter.

ENTER

[Video CD] Press ▼ to select "Repeat". Press ENTER repeatedly to select "Track" or "All".

The unit automatically starts repeat playback after finishing the current track.

ENTER

Play Mode
Repeat : Off

Play Mode
Mode : Off
Repeat : Off

 - If you set the repeat mode during stop mode, press **PLAY** to start Repeat playback.
- 3 Press PLAY MODE again to clear the screen.**

To resume normal playback
Select Repeat : "Off" in step 2.

- Note:**
- Some discs may not work with the repeat operation.
 - In case of Video CD with PBC, Repeat function is prohibited during playback.
 - Chapter/Track repeat function is canceled whenever **SKIP** ◀◀ or ▶▶ is pressed.

DVD VCD CD A-B Repeat playback

A-B repeat playback allows you to repeat a section between two selected points.

- 1 Press REPEAT A-B during playback.**

REPEAT A-B

The start point is selected.
- 2 Press REPEAT A-B again.**

REPEAT A-B

The end point is selected. Playback starts at the point that you selected. Playback stops at the end point and returns to Point A automatically, then starts again.

To resume normal playback
Press **REPEAT A-B** again.
REPEAT A-B
"Off" appears on the screen.

- Note:**
- In A-B Repeat mode, subtitles near the A or B locations may not be displayed.
 - You cannot set the A-B Repeat for the scenes that include multiple angles.
 - A-B Repeat playback does not work when Repeat playback is activated.
 - You may not be able to set A-B Repeat during certain scenes of the DVD.
 - A-B Repeat does not work with an interactive DVD and MP3/WMA/JPEG CD.
 - In case of Video CD with PBC, A-B Repeat is prohibited.

Advanced playback

Program playback/Random playback

You can arrange the playback order of tracks on the disc. And the unit can also select tracks at random and playback them. These features work for Video CD.

For Audio CD and MP3/WMA CD, please see “Random playback” (Audio CD/MP3/WMA/JPEG/DivX®) **58** and “Program playback” (Audio CD/MP3/WMA/JPEG/DivX®) **59**.

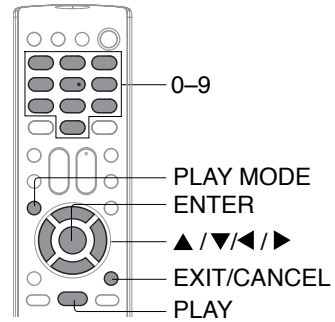

VCD Program playback

1 Press **PLAY MODE** in the stop mode.

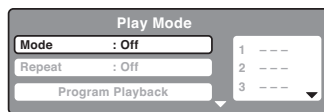

2 Press **▲** or **▼** to select “Mode”, then press **ENTER** repeatedly to select “Program”.



3 Press **◀/▶** to select the programming position. Press **▲/▼** and then use **Number buttons (0–9)** to input the track.



- To program others, repeat this step.
- If you input a wrong number, press **EXIT/CANCEL**.

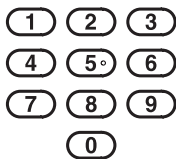

4 Press **◀/▶** to return to the left column, then press **▲/▼** to select the “Program Playback” and press **ENTER**.

The programs you selected will start to playback in order.

- To resume normal playback, select Mode: “Off” in step 2.

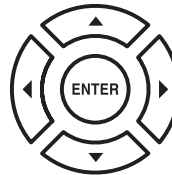

■ To change the program

1. Select Mode to “Program” (as step 2), press **▲/▼/◀/▶** to select the track number you want to change, then press **EXIT/CANCEL**.
2. Press **Number buttons (0–9)** to input the new track number.

■ To clear the program one by one

Select Mode to “Program”, press **▲/▼/◀/▶** to select the track number. Then press **EXIT/CANCEL**.

■ To clear all the programs

At the left column, press **▲/▼** to select “Clear Program”. Then press **ENTER**.

Note:

- In playing back the Video CD with PBC, you cannot set Program playback.
- The program is cancelled when you eject the disc or turn the power off.

VCD Random playback

1 Press **PLAY MODE** during playback or stop mode.



2 Press **▲/▼** to select “Mode”, then press **ENTER** repeatedly to select “Random”.



3 Press **PLAY**.



The Random Playback will start.

- If you set “Random” during playback mode, Random playback will begin after the track that is currently being played has ended.
- To resume normal playback, select Mode: “Off” in step 2.

Note:

- In case of Video CD with PBC, you cannot set Random function during playback.

Changing angles/Title selection/DVD menu

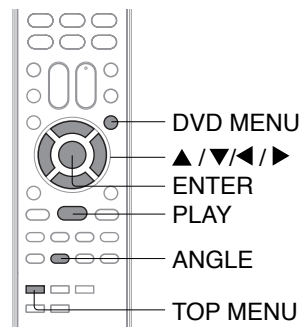

DVD Changing angles

When playing back a disc recorded with multi-angle facility, you can change the angle that you are viewing the scene from.

- 1** Press **ANGLE** during playback.
The current angle will appear.

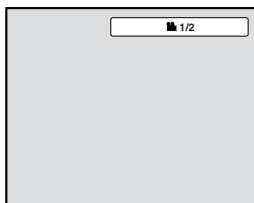

- 2** Press **ANGLE** repeatedly until the desired angle is selected.



Note:

- Depending on the DVD, you may not be able to change the angle even if multi-angles are recorded on the DVD.

DVD Title selection

Two or more titles are recorded on some discs. If the title menu is recorded on the disc, you can select the desired title.

- 1** Press **TOP MENU** during playback.
Title menu appears on the screen.



- 2** Press **▲/▼/◀/▶** to select the desired title.



- 3** Press **ENTER** or **PLAY**.



The playback of the selected title will start.

Note:

- Depending on the DVD, you may not be able to select the title.
- Depending on the DVD, a "title menu" may simply be called a "menu" or "title" in the instructions supplied with the disc.

DVD DVD menu

Some DVDs allow you to select the disc contents using the menu.

When you playback these DVDs, you can select the subtitle language, soundtrack language, etc, using the menu.

- 1** Press **DVD MENU** during playback.
The DVD menu appears on the TV screen.
- Press **DVD MENU** again to resume playback at the scene when you pressed **DVD MENU**.



- 2** Press **▲/▼/◀/▶** to select the desired item.



- 3** Press **ENTER**.



The menu continues to another screen. Repeat steps 2 and 3 to set the item completely.

Note:

- Depending on the DVD, you may not be able to resume playback from the scene point when you press **DVD MENU**.

Changing soundtrack language/Subtitles

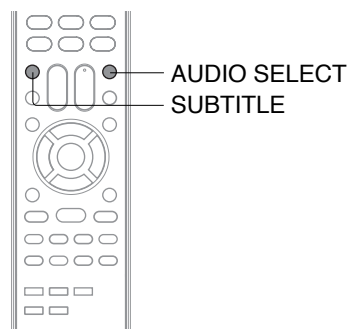

Changing soundtrack language

You can select the language when you play a multilingual disc.

1 Press **AUDIO SELECT** during playback.



The current soundtrack language will appear.

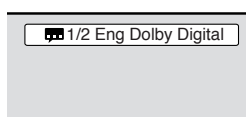

2 Press **AUDIO SELECT** repeatedly until the desired language is selected.

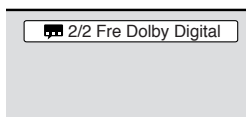

- The on screen display will disappear after a few seconds.

■ In case of Video CD playback

Audio type changes as follows each time you press **AUDIO SELECT**.



Note:

- If the desired language is not heard after pressing the button several times, the language is not recorded on the disc.
- The selected soundtrack language is cancelled when you eject the disc. The initial default language or available language will be heard if the disc is played back again.
- If you select DTS in playing DTS-encoded disc, no sound will be heard from the TV/DVD's speakers.

Subtitles

When playing back a disc recorded with subtitles, you can select the subtitle language or turn the subtitle off.

1 Press **SUBTITLE** repeatedly during playback until the desired language is selected.

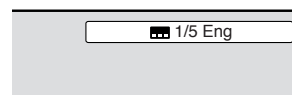

2 To turn off the subtitle, press **SUBTITLE** until "Off" appears.



- The on screen display will disappear after a few seconds.

Note:

- Depending on the DVD, you may not be able to change subtitles, or to turn subtitles on or off.
- While playing a DVD, the subtitle may change when you loaded or eject the disc.
- In some cases, a selected subtitle language may not be changed immediately.

Disc status/To turn off the PBC

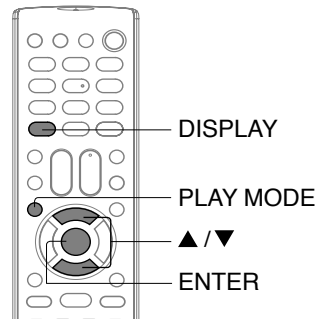

Disc status

With press of DISPLAY, the status of the disc will appear on the screen. To cancel the display, press DISPLAY again.

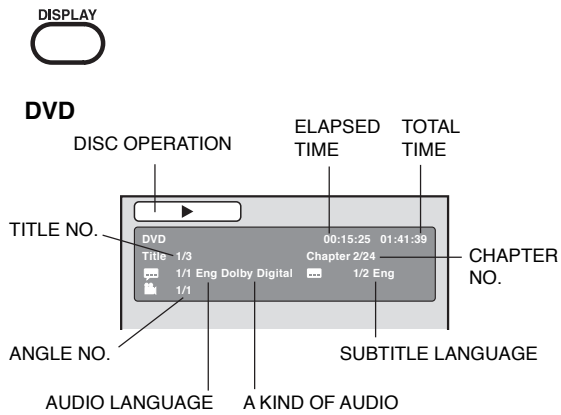

Video CD

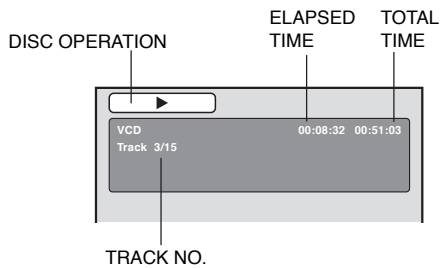

To turn off the PBC (see page 7)

1 Press PLAY MODE in the stop mode.



2 Press ▲/▼ to select "Mode", then press ENTER repeatedly until "Off" appear.



3 Press PLAY MODE again to clear the screen.



■ To turn on the PBC

Follow the above steps 1~2, then press ENTER repeatedly until "PBC" appear.

Advanced playback

MP3/WMA/JPEG/DivX[®] and Audio CD operation

This unit can playback the MP3/WMA/JPEG/DivX[®]-data which has been recorded on CD-R or CD-RW. To produce the MP3/WMA/JPEG/DivX[®]-data, you need a Windows-PC with CD-RW drive and a MP3/WMA/JPEG/DivX[®]-encoding Software (not supplied). The Apple-HFS-System cannot be played.

This player requires discs/recordings to meet certain technical standards in order to achieve optimal playback quality. There are many different types of recordable disc formats (including CD-R containing MP3/WMA files). Not all recordable discs will produce optimal playback quality. The technical criteria set forth in this owner's manual are meant only as a guide. Use of CD-RW for MP3 files is not recommended.

You must obtain any required permission from copyright owners to download or use copyrighted content. Toshiba cannot and does not grant such permission.

CD Audio CD/MP3/WMA/JPEG/DivX[®] CD information

Limitations on MP3/WMA/JPEG/DivX[®] CD playback

- MP3/WMA/JPEG/DivX[®] CD is the disc that is standardized by ISO9660, its file name must include 3-digits extension letters, ".mp3", ".wma", ".jpg", ".div", ".divx", ".avi".
- MP3/WMA/JPEG/DivX[®] CD must be correspond to the ISO standardized files.
- This unit can read 2000 files per disc. If one disc has more than 2000 files, it reads up to 2000 files, the remaining files will be omitted.
- MP3/WMA/JPEG/DivX[®] CDs cannot be used for the purpose of recording.
- If the CD has both audio tracks and MP3/WMA/JPEG/DivX[®] files, only audio tracks will be played.
- It may take more than one minute for this unit to read MP3/WMA/JPEG/DivX[®] files depending on its structure.
- Music recorded by "Joliet Recording Specification" can be played back, the file name is displayed (within 15 letters) on the screen. Long file names will be condensed.
- The music files recorded by "Hierarchical File System" (HFS) cannot be played.

Limitations on display

- The maximum number for display is 15 letters.
Available letters for display are the following:
capital or small alphabets of A through Z, numbers of 0 through 9, and _ (under score).
- Other letters than those above are replaced in hyphen.

Notes on MP3/WMA/JPEG/DivX[®] files

To playback MP3/WMA/JPEG/DivX[®] CD in the recorded order,

1. Use MP3/WMA/JPEG/DivX[®] software that records data alphabetically or numerically.
2. Name each file including two-digit or three-digit number (ex. "01" "02" or "001" "002").
3. Refrain from making too many sub-folders.

CAUTION:

- Some MP3/WMA/JPEG/DivX[®] CDs cannot be played back depending on the recording conditions.
- The CD-R/RW that has no music data or non MP3/WMA/JPEG/DivX[®] files cannot be played back.

Standard, sampling frequency and the bit rate:

MP3 CD

MPEG-1 Audio

32kHz, 44.1kHz, 48kHz

32kbps ~ 320kbps (constant bit rate or variable bit rate)

The recommend recording setting for a high-quality sound is 44.1kHz of sampling frequency and 128kbps of constant bit rate.

WMA CD

WMA version 7 and 8

32kHz/48kbps, 44.1kHz/48kbps~192kbps, 48kHz/128kbps~192kbps

The file recorded by mono, 48kHz, 48 kbps is not available to this unit.

DivX[®] video

DivX[®] version: DivX[®] 3, 4, 5, and 6 (specifically 3.1.1, 4.1.2, 5.0.2, 5.0.5, 5.1.1, 5.2.1, 6.0 at Home Theater profile).

Audio format: MPEG1 Layer2 (MP2), MPEG1 Layer3 (MP3)

Sampling frequencies: 32kHz, 44.1kHz, 48kHz

Bit rate: 32kbps ~ 320kbps

Resolution: Max 720 x 576 (at 25fps), Max 720 x 480 (at 30fps)

Microsoft, Windows Media, and Windows Logo are either registered trademarks or trademarks of Microsoft Corporation in the United States and/or other countries.

DivX, DivX Certified, and associated logos are trademarks of DivX, Inc. and are used under license.

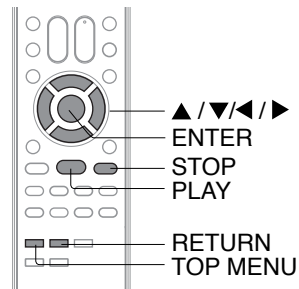

CD MP3/WMA and Audio CD playback

1 Load an Audio CD or a disc on which MP3 or WMA files have been recorded in the disc slot.

2 A file browser screen will appear on the screen.

3 Press ▲/▼ to select file.

- In case the current directory includes more than 8 files, press ▲ or ▼ to scroll in the file list.
- To see contents in folder, select the folder and then press **ENTER**. To return to the parent directory, press **RETURN** or select "Go Up ..." then press **ENTER**.
- When **PLAY** is pressed after the file browser displayed, playback begins automatically starting from the first file. In this case, if the first file is an MP3/WMA file, only MP3/WMA files are played back in order. If the first file is a JPEG file, the first JPEG file is played back. If the first file is a DivX® file, the first DivX® file is played back. If there is no file at a root directory, playback does not begin automatically.

4 Press **ENTER**.
The selected file starts playing back.

5 Press **STOP** to end playback.

- The unit records the stopped point. "■" appears on the TV screen. Press **PLAY** to resume playback (from the scene point).
- If you press **STOP** again or unload the disc, the unit will clear the stopped point.

About file menu

♪ : Indicates Music file (Audio CD/MP3/WMA)
 🖼️ : Indicates Picture file (JPEG)
 🎬 : Indicates Movie file (DivX® video)

Note:

- In the case of a CD containing a mixture of MP3, WMA, JPEG and DivX® files, the files are played back by selecting them from the file browser.
- MP3 or WMA file on the Kodak Picture CD is not recognized on this unit.

Note:

- During MP3/WMA playback, you cannot use Jump and A-B Repeat functions.
- You can use Repeat (Track or All), Random functions and Program playback for Audio CD/MP3/WMA/JPEG/DivX® playback [58] [59].

■ Select Files
The file type to make it display in the file browser can be chosen.

1. Press ◀ or ▶ to highlight "Select Files" at right column in the file browser.
2. Press **ENTER**, then press ▲ or ▼ to select file type from the list (Music, Picture or Movie).
3. Press **ENTER** to add/remove check mark. Checked file type will be displayed in the file browser.
4. Press **RETURN** to save the setting.

Advanced playback

MP3/WMA/JPEG/DivX® and Audio CD operation (Continued)

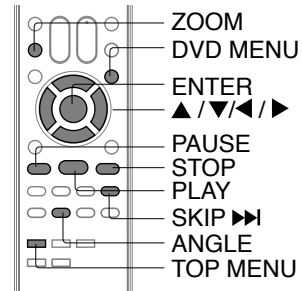

CD JPEG playback

- 1 Load a JPEG disc in the disc slot.**
- 2 A file browser screen will appear on the screen.**
- 3 Press ▲/▼ to select the file.**
To display a thumbnail list, press **DVD MENU**. Press ◀/▶/▲/▼ to select the desired file. (To return to the file browser, press **TOP MENU**.)
 - When **PLAY** is pressed after the file browser displayed, playback begins automatically starting from the first file. In this case, if the first file is a JPEG file, the first JPEG file is played back. If the first file is a DivX® file, the first DivX® file is played back. If the first file is an MP3/WMA file, only MP3/WMA files are played back in order. If there is no file at a root directory, playback does not begin automatically.
- 4 Press ENTER or PLAY. The selected picture appears on the screen.**

Rotating an image
You can rotate an image by 90 degrees. Press **ANGLE** during playback of the image. "↔", "↕", "↔↕" or "↕↔" appears on the screen.

Zooming an image
Zoom function also can be used in viewing JPEG files. Press **ZOOM** (See "Zooming" [47](#)).
- 5 Press STOP to end playback.**

The file browser appears on the screen. If you want to watch the other file, repeat steps 3 ~ 4.

CD Slide show playback

- The slide show enables you to view pictures (files) one after another automatically.
- Preparation:**
- Set "JPEG Interval" setting to "5 Seconds", "10 Seconds" or "15 Seconds" ([63](#)).
- 1 Select your desired starting file for the slide show in the step 3 on left.**
 - 2 Press ENTER or PLAY to start slide show from the selected file.**
 - If you press **PAUSE** during the slide show, the slide show stops temporary. "||" appears briefly on the TV screen. Press **PLAY** or **SKIP** ▶▶ again to resume the slide show.
 - If the picture appears upside down or sideways, press **ANGLE** repeatedly until it's right side up. "↔", "↕", "↔↕" or "↕↔" appears on the TV screen.
 - When the slide show playback finished, the file list appears.
 - To stop the slide show, press **STOP**. The file browser appears.

- Note:**
- During JPEG playback, you cannot use Jump and A-B Repeat functions.
 - When an image exceeds 5760 x 3840 pixels, the entire image may not be displayed on a screen, preview window or thumbnail list.
 - It may have a longer interval due to the size of data.

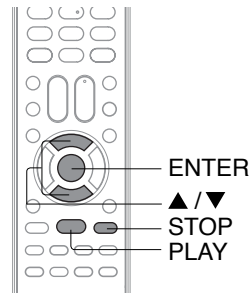

CD DivX® playback

- 1** Load a disc on which DivX® files have been recorded in the disc slot.
- 2** A file browser screen will appear on the TV screen.
- 3** Press ▲/▼ to select file.

 - When **PLAY** has been pressed after the file browser displayed, playback begins automatically starting from the first file. In this case, if the first file is a JPEG file, the first JPEG file is played back. If the first file is a DivX® file, the first DivX® file is played back. If the first file is an MP3/WMA file, only MP3/WMA file are played back in order. If there is no file at a root directory, playback does not begin automatically.
- 4** Press **ENTER** or **PLAY**. The selected DivX® movie will be played back on the TV screen.
- 5** Press **STOP** to end playback.

 - The unit records the stopped point. “■” appears on the TV screen. Press **PLAY** to resume playback (from the scene point).
 - If you press **STOP** again or un-load the disc, the unit will clear the stopped point. To want to watch the other file, repeat steps 3 ~ 4.

CD Playing DivX® VOD content

DivX® VOD content is protected by DRM (Digital Rights Management) system. This restricts playback of content to specific registered devices.

If the incorrect DRM file is loaded, “Authorization Error This player is not authorized to play this video.” will appear on the screen.

When you attempt to play DivX® VOD, the number of plays is limited and the right message will appear on the screen. If you wish to play it, select “Yes”.

- If the number of plays goes over the limit, then “Rental Expired” will be displayed. In this case, the file will not be played.

- Note:**
- In order to play DivX® VOD content on this unit, you first need to register the unit with registration code. See page 64.
 - Depending on the recording conditions of DivX® file, you may not be able to use FF, REV or JUMP function.

Advanced playback

Repeat, random and program playback using file browser

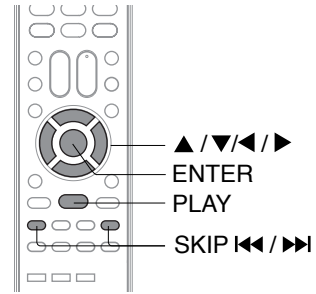

CD Repeat playback (Audio CD/MP3/WMA/JPEG/DivX®)

- In the file browser, press ◀/▶/▲/▼ to select "Repeat" during stop mode.
- Press ENTER repeatedly to select "Track" or "All".
- Press PLAY.

The unit automatically starts repeat playback after finishing the current track.

■ **To resume normal playback**
Select Repeat : "Off" in step 2.

- Note:**
- The repeat function is cancelled when you eject the disc or turn the power off.
 - Track repeat function is canceled whenever **SKIP** ◀◀ or ▶▶ is pressed.
 - The function of A-B Repeat can be used for DivX® CD. See "A-B Repeat playback" [49](#).

CD Random playback (Audio CD/MP3/WMA/JPEG/DivX®)

- In the file browser, press ◀/▶/▲/▼ to select "Mode" during stop mode.
- Press ENTER to select "Random".
- Press PLAY.

The random playback will start.

■ **To resume normal playback**
Select Mode : "Off" in step 2.

- Note:**
- The random function is cancelled when you eject the disc or turn the power off.

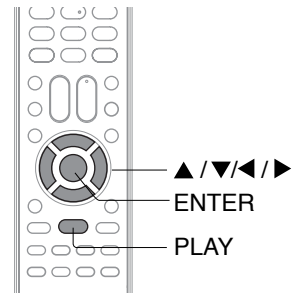

CD Program playback (Audio CD/MP3/WMA/JPEG/DivX®)

1 In the file browser, press ◀/▶/▲/▼ to select “Edit Mode”, then press ENTER.

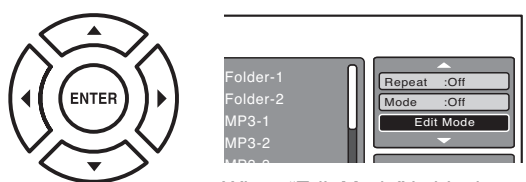

When “Edit Mode” is black color, you can mark the files which you want to add into Program list.

2 Press ◀/▶/▲/▼ to select file you want to add into the program list.

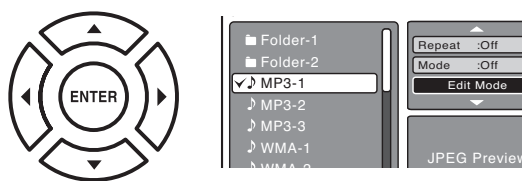

Press ENTER. Selected file was marked. Repeat this procedure to select the other files.

3 Press ◀/▶/▲/▼ to select “Add To Program”. Then press ENTER. All marked files are added into the program list.

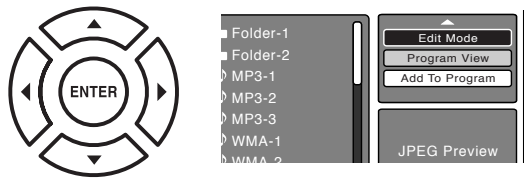

When you finish storing the files which you want into the Program list, select “Edit Mode” and press ENTER to release edit mode.

4 Press ▲/▼ to select “Program View”, then press ENTER. Program View shows only the programmed files that you have added in step 2.

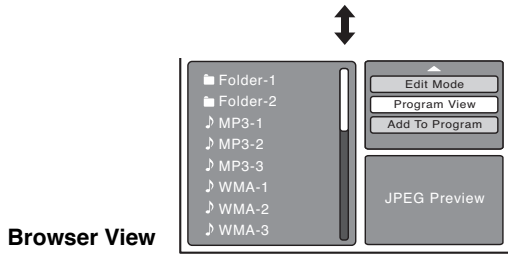
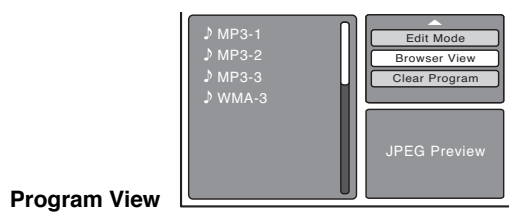

5 In the Program View, press PLAY. The files start to playback in programmed order that were added by you.

To remove file from program list in stop mode
 In the Edit Mode, switch to Program View. Select file you want to remove, then press ENTER. Select “Clear Program” and press ENTER. Marked file is removed from program list.

Note:
 • The program function is cancelled when you eject the disc or turn the power off.

Advanced playback

Customizing the function settings

You can change the default settings of the DVD mode to customize performance to your preference.

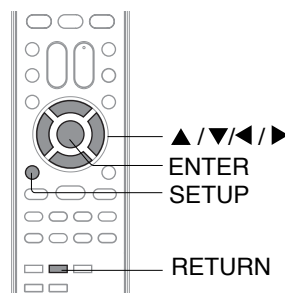

DVD VCD CD Setting procedure

1 Press **SETUP** during stop mode. The following on-screen display appears.

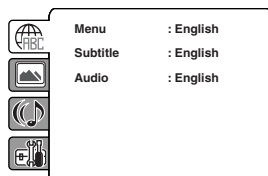

2 Press **▲** or **▼** to select the desired section, then press **◀** or **▶**.

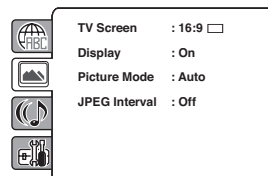
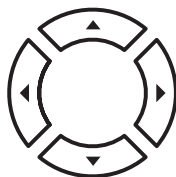

3 First option will be highlighted. Press **▲** or **▼** to select the desired option.

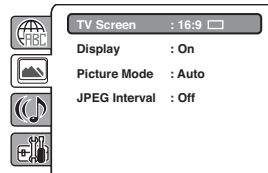

4 Then press **▶** or **ENTER**. The selectable settings will appear.

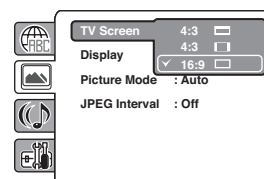

5 Change the selection using **▲** or **▼**, by referring to the corresponding pages **61** ~ **64**. Press **ENTER** to save the setting.

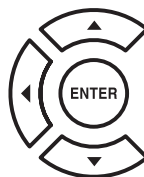





- Repeat steps 3 and 5 to change other option.
- To select another section, go back to step 2 by pressing **◀** repeatedly.

6 To clear **SETUP** screen, press **SETUP** once or press **RETURN** repeatedly.



Setting details

Section	Option	Details	Page
	Menu Subtitle Audio	To select the language of "Menu", "Subtitle" and "Audio" if more than one language are available on the disc.	62
	TV Screen	To select a picture size according to the aspect ratio of your TV.	62
	Display	To turn On or Off the operational status display on the TV screen.	
	Picture Mode	To select a preferred picture mode from "Video", "Film" or "Auto".	63
	JPEG Interval	To select a preferred setting for the slide show playback.	
	Night Mode	To select On or Off for Night Mode.	63
	Digital Out	To select a digital output sound format corresponding to your system connection.	
	Parental	To select a preferred parental level for the parental setting.	64
	Password	To change the password.	
	DivX(R) VOD	To display your 8-character registration code.	

Function setup

Customizing the function settings (Continued)

Setting details



Menu : English
 Subtitle : English
 Audio : English

■ Menu, Subtitle, Audio

You can select the language of “Menu”, “Subtitle” and “Audio” if more than one languages are recorded onto the disc.

English, Francais, Espanol:

The selected language will be heard or seen.

Other:

Other language can be selected (see “Language code list” [69](#)).

Original (Audio):

The unit will select the first priority language of each disc.

Off (Subtitle):

Subtitles do not appear.

Note:

- If the selected language is not recorded on the disc, the first-priority language is selected.
- If you want to change the OSD language, you can perform it by “Language” in the TV menu [22](#).



TV Screen : 16:9
 Display : On
 Picture Mode : Auto
 JPEG Interval : Off

■ TV Screen

You have the following screen sizes to choose from:

4:3 (Letter box):

When playing back a wide screen-DVD disc, it displays the wide picture with black bands at the top and bottom of screen.

4:3 (Pan & scan):

It displays the wide picture on the whole screen with left and right edges automatically cut off.

16:9 (Wide):

A wide screen picture is displayed full size.

Note:

- If the DVD disc is not formatted in the Pan & scan style, it will display 4:3 style.

■ Display

On screen display can be switched on or off when you press any buttons.

Off: On screen displays do not appear when you press any buttons.

On: On screen displays appear when you press the buttons (factory setting).

Setting details (continued)

Picture Mode

There are two types of source content in pictures recorded in DVD video discs: film content (pictures recorded from films at 24 frames per second) and video content (video signals recorded at 30 frames per second). Make this selection according to the type of content being viewed.

Auto: Select this selection normally. The DVD player automatically detects source content, film or video of playback source, and converts that signal in an appropriate method.

Film: The DVD player converts film content pictures appropriately. Suitable for playback of film content pictures.

Video: The DVD player filters video signal and converts it appropriately. Suitable for playback of video content pictures.

Note:

- Depending on the disc, pictures may be cut off or doubled. In this case, select "Video".

JPEG Interval

You can continuously playback all JPEG files automatically.

After the selection below, the disc will start playback on JPEG files which have been recorded.

Off:
Plays back one file at a time.

5 Seconds:
Plays back images in the form of a slide show at 5 second intervals.

10 Seconds:
Plays back images in the form of a slide show at 10 second intervals.

15 Seconds:
Plays back images in the form of a slide show at 15 second intervals.



Night Mode : Off
Digital Out : Bitstream

Night Mode

Night Mode enables you to control the dynamic range so as to achieve a suitable sound for your equipment.

Off: It plays back at the recording level on the disc.

On: Loud sound such as explosion is toned down slightly when played back. This is suitable when it is connected to a stereo.

Note:

- This function works only when the disc recorded with Dolby Digital is played back.
- The level of Night Mode may differ depending on DVD video disc.

Digital Out

You can select the digital output sound format corresponding to your system connection.

Off:
There is no sound output from DIGITAL AUDIO OUT jack.

PCM:
Change Dolby Digital to PCM for the output. Select when connected to a 2 channel digital stereo amplifier.

Bitstream:
Disc audio bitstream data will be output.

Note:

- Even if you select "Bitstream", MPEG Audio will be output in PCM format.

Customizing the function settings (Continued)

Setting details (continued)

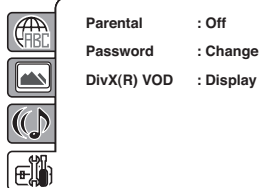

■ Parental control setting

Some discs are specified as not suitable for children. Such discs can be limited not to playback with the unit.

- 1) Press **▲** or **▼** to select "Parental", then press **ENTER**. "Enter Password" screen will appear.
- 2) Press "0000" using **Number buttons (0-9)**. (Please note, this is pre-setting password of this unit). Then press **ENTER**. The parental level list will appear.
 - **Level Off:** The parental control setting does not function.
 - **Level 8:** Virtually all DVD software can be played back.
 - **Level 1:** DVD software for adults cannot be played back.
- 3) Press **▲** or **▼** to select from the level 1 to level 8. The limitation will be more severe as the level number is lower. Then press **ENTER**.

Note:

- The parental control level is equivalent to the following USA movie ratings.

Level 1: G	Level 5:
Level 2:	Level 6: R
Level 3: PG	Level 7: NC-17
Level 4: PG-13	Level 8:

The parental control levels for other countries/area than U.S. are included for future use. Check the appropriate parental control level when you buy a DVD video disc equipped with the parental control feature in the future.

- Depending on the discs, the unit cannot limit playback.
- Some discs may not be encoded with specific rating level information though its disc jacket says "adult." For those discs, the age restriction will not work.
- The password is required every time when you change the parental level.
- If you input a wrong number, press **EXIT/CANCEL**.

■ Set the new password

- 1) Press **▲** or **▼** to select "Password", then press **ENTER**. "Enter Current Password" screen will appear.
- 2) Press **Number buttons (0-9)** to input the current password (If the password has not been set yet after you purchase this unit, it is "0000").
- 3) Then press **ENTER**. "Enter New Password" screen will appear. Press **Number buttons (0-9)** to input the new password.
- 4) Press **ENTER**. Now your new password has been set. Be sure to remember this number!

If you forget the password

- 1) Press **EJECT** to remove the disc.
- 2) While holding **7** down on the remote control and then press **STOP** on the unit. "Password Clear" appears on the screen. Now the password has been returned to the initial value ("0000").

■ DivX® VOD

In order to play DivX® VOD (Video On Demand) content on this unit, you first need to register the unit with your DivX® VOD content provider. You do this by generating a DivX® VOD registration code, which you submit to your provider.

Press **▲** or **▼** to select "DivX(R) VOD". Then press **ENTER**. Your 8-character registration code is displayed. Make a note of the code as you will need it when you register with a DivX® VOD provider. Then press **ENTER** to select Done.

Note:

- If each setup (pages **62** ~ **64**) has completed, the unit can always work under the same condition (especially with DVD discs). Each setup will be retained in the memory even if you turn the power off.

Temporary cancel the rating level by DVD disc

Depending on the DVD disc, the disc may try to temporarily cancel the rating level that you have set.
It is up to you to decide whether to cancel the rating level or not.

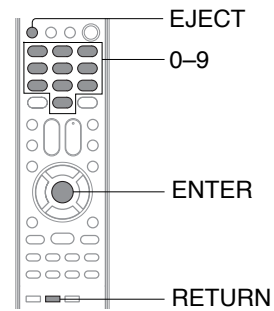

DVD Temporary cancel the rating level by DVD disc

1 Load a DVD disc.

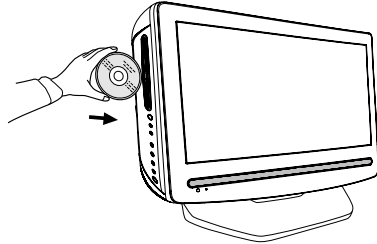

2 If the DVD disc has been designed to temporarily cancel the Rating level, the screen which follows the "Reading" screen will change, depending on which disc is played. If you select "YES" with the ENTER key, password input screen will then appear.

- If "NO" is selected, press EJECT to remove the disc.

3 Enter the password with Number buttons (0-9). Then press ENTER.

To exit from the entry, press
RETURN.

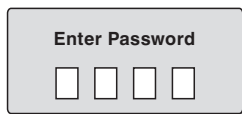
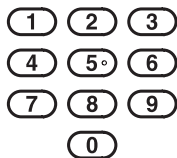

4 Playback will commence if the entered password is correct.

Note:

- This temporary cancellation of rating level will be kept until the disc is ejected. When the disc is ejected, the original rating level will be set again automatically.

Understanding the Power Return feature

If the power is cut off while you are viewing the TV/DVD and the power is resupplied, the Power Return feature will turn the TV/DVD on automatically. If the power is going to be off for a long time or you are going to be away from the TV/DVD for a long time, unplug the power cord from the wall outlet to prevent the TV/DVD from turning on in your absence.

Troubleshooting

Use the following check list for troubleshooting when you have problems with your unit. Consult your local dealer or service outlet if problems persist.

Be sure all connections are properly made when using with other units.

SYMPTOMS	POSSIBLE SOLUTIONS	PAGE
POWER		
TV/DVD does not operate.	<ul style="list-style-type: none"> • Make sure the connection of AC cord is secured. • Try another AC outlet. • Unplug unit, then plug it back in. 	20
TV BROADCAST RECEPTION		
Poor sound or No sound.	<ul style="list-style-type: none"> • Station or Cable TV may have problems, try another station. • Check Volume adjustments or mute. • Check for sources of possible interference. 	26 26, 27 68
Poor picture or No picture.	<ul style="list-style-type: none"> • Station or Cable TV may have problems, try another station. • Check antenna or Cable TV connections, reorient antenna. • Check for sources of possible interference. • Check Picture setting. 	26 14, 15 68 36
Poor reception on some channels.	<ul style="list-style-type: none"> • Station or Cable TV may have problems, try another station. • Station signal is weak, reorient antenna to receive weaker station. • Check for sources of possible interference. 	26 14 68
Poor color or no color.	<ul style="list-style-type: none"> • Station or Cable TV may have problems, try another station. • Make sure channels are set into memory. • Check Picture setting. • Check antenna or Cable TV connections, reorient antenna. • Check for sources of possible interference. 	26 23 36 14, 15 68
Picture wobbles or drifts.	<ul style="list-style-type: none"> • Station or Cable TV may have problems, try another station. • Make sure channels are set into memory. • Cable TV company is scrambling signal. • Check antenna or Cable TV connections, reorient antenna. 	26 23 - 14, 15
No CATV reception.	<ul style="list-style-type: none"> • Check all Cable TV connections. • Set Air/Cable selection to the Cable position. • Station or Cable TV system problems, try another station. 	15 23 26
Horizontal or diagonal bars on screen.	<ul style="list-style-type: none"> • Check antenna or Cable TV connections, reorient antenna. • Check for sources of possible interference. 	14, 15 68
No reception above channel 13.	<ul style="list-style-type: none"> • Make sure Air/Cable selection is in the appropriate position. • If antenna is used, check UHF antenna connections. 	23 14
TV shuts off.	<ul style="list-style-type: none"> • Auto shut off feature worked. • Sleep Timer is set. • Power interrupted. 	43 27 -
Closed - Caption is not activated.	<ul style="list-style-type: none"> • TV station experiencing problems or program tuned is not closed captioned. Try another channel. • Check Cable TV connection or VHF/UHF antenna, reposition or rotate antenna. • Set "CC Setting" to "On" to turn on the closed caption decoder. 	26 14, 15 34
Display is not shown in your language.	<ul style="list-style-type: none"> • Select proper language in the menu options. 	22

SYMPTOMS	POSSIBLE SOLUTIONS	PAGE
DVD		
Playback doesn't start.	<ul style="list-style-type: none"> • No disc is loaded. • The disc may be dirty. Clean up the disc. • The unit cannot play CD-ROMs, etc. 	44 7 8
No picture.	<ul style="list-style-type: none"> • TV/DVD selector is not set correctly. 	44
No sound.	<ul style="list-style-type: none"> • Check the input selector of the amplifier is set properly. • The unit is in the special playback mode. • Select the correct Audio Input/Output position on AV amplifier. 	- 46 18, 19
Picture is distorted during fast reverse/forward playback.	<ul style="list-style-type: none"> • The picture will be distorted occasionally. 	-
Stopping playback, search, slowmotion play, repeat play, or program play, etc. cannot be performed.	<ul style="list-style-type: none"> • Some discs may not do some of the functions. 	-
No on-screen display.	<ul style="list-style-type: none"> • Set Display to On. 	62
The unit or remote operation key is not functioning.	<ul style="list-style-type: none"> • Turn off the unit and unplug the AC power cord for several minutes, then replug it. 	-
Playback does not start when the title is selected.	<ul style="list-style-type: none"> • Check the Parental setup. 	64
Audio soundtrack and/or subtitle language is not changed when you playback a DVD.	<ul style="list-style-type: none"> • Multilingual language is not recorded on the DVD disc. 	52
No subtitle.	<ul style="list-style-type: none"> • Some discs have no subtitles. • Subtitles are cleared. Press SUBTITLE. 	52
Angle cannot be changed.	<ul style="list-style-type: none"> • Multi-angles are not recorded on the DVD disc. 	51
"X" appears on the screen.	<ul style="list-style-type: none"> • The function is prohibited with the unit or the disc. 	46
REMOTE CONTROL		
The remote control does not function.	<ul style="list-style-type: none"> • Aim the remote control at the remote sensor. • Operate within approx. 5 meters or reduce the light in the room. • Clear the path of the beam. • The batteries are weak. Replace the batteries. • Check the batteries are inserted correctly. 	13

Others

Reception disturbances

Most types of television interference can be remedied by adjusting the height and position of the VHF/UHF antenna. Outdoor antennas are recommended for best results. The most common types of television interference are shown below. If one of these symptoms appear when the TV/DVD is connected to a Cable TV system, the disturbance may be caused by the local Cable TV company broadcast.

IGNITION

Black spots or horizontal streaks may appear, the picture may flutter or drift. Usually caused by interference from automobile ignition systems, neon lamps or AC powered tools and appliances such as drills or hair dryers.



GHOSTS

Ghosts are caused by the television signal following two paths. One is the direct path and the other is reflected by tall buildings, hills or other large objects. Changing the direction or position of the antenna may improve the reception.

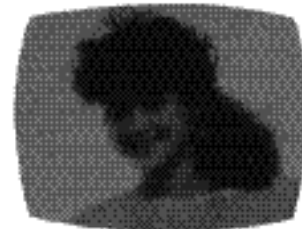

SNOW

If the TV/DVD is located far from the TV station, in a fringe reception area where the signal is weak, small dots may appear in the picture. If the signal is extremely weak, the installation of a larger external antenna may be necessary.



RADIO FREQUENCY INTERFERENCE (RFI)

Caused by two-way radios, this type of interference produces moving ripples or diagonal streaks in the picture. Some cases may cause a loss of contrast in the picture. Changing the direction and position of the antenna or installing an RFI filter may improve the picture.

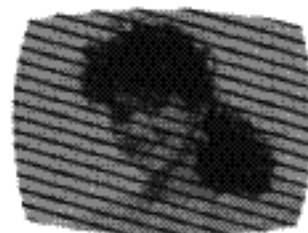

CARE AND MAINTENANCE

To prevent fire or shock hazard, disconnect the TV/DVD from the power source before cleaning. Use caution when cleaning or wiping the plastic parts.

Language code list

Enter the appropriate code number for the initial settings "Menu", "Subtitle" and/or "Audio" [62].

Language Name	Code	Language Name	Code	Language Name	Code	Language Name	Code
Abkhazian	1112	Fiji	1620	Lingala	2224	Singhalese	2919
Afar	1111	Finnish	1619	Lithuanian	2230	Slovak	2921
Afrikaans	1116	French	1628	Macedonian	2321	Slovenian	2922
Albanian	2927	Frisian	1635	Malagasy	2317	Somali	2925
Amharic	1123	Galician	1722	Malay	2329	Spanish	1529
Arabic	1128	Georgian	2111	Malayalam	2322	Sundanese	2931
Armenian	1835	German	1415	Maltese	2330	Swahili	2933
Assamese	1129	Greek	1522	Maori	2319	Swedish	2932
Aymara	1135	Greenlandic	2122	Marathi	2328	Tagalog	3022
Azerbaijani	1136	Guarani	1724	Moldavian	2325	Tajik	3017
Bashkir	1211	Gujarati	1731	Mongolian	2324	Tamil	3011
Basque	1531	Hausa	1811	Nauru	2411	Tatar	3030
Bengali; Bangla	1224	Hebrew	1933	Nepali	2415	Telugu	3015
Bhutani	1436	Hindi	1819	Norwegian	2425	Thai	3018
Bihari	1218	Hungarian	1831	Oriya	2528	Tibetan	1225
Breton	1228	Icelandic	1929	Panjabi	2611	Tigrinya	3019
Bulgarian	1217	Indonesian	1924	Pashto, Pushto	2629	Tonga	3025
Burmese	2335	Interlingua	1911	Persian	1611	Turkish	3028
Byelorussian	1215	Irish	1711	Polish	2622	Turkmen	3021
Cambodian	2123	Italian	1930	Portuguese	2630	Twi	3033
Catalan	1311	Japanese	2011	Quechua	2731	Ukrainian	3121
Chinese	3618	Javanese	2033	Rhaeto-Romance	2823	Urdu	3128
Corsican	1325	Kannada	2124	Romanian	2825	Uzbek	3136
Croatian	1828	Kashmiri	2129	Russian	2831	Vietnamese	3219
Czech	1329	Kazakh	2121	Samoan	2923	Volapük	3225
Danish	1411	Kirghiz	2135	Sanskrit	2911	Welsh	1335
Dutch	2422	Korean	2125	Scots Gaelic	1714	Wolof	3325
English	1524	Kurdish	2131	Serbian	2928	Xhosa	3418
Esperanto	1525	Laothian	2225	Serbo-Croatian	2918	Yiddish	2019
Estonian	1530	Latin	2211	Shona	2924	Yoruba	3525
Faroese	1625	Latvian, Lettish	2232	Sindhi	2914	Zulu	3631

Specifications

Model	19LV505 / 19LV506	22LV505
General		
Power supply	AC 120V 60Hz	
Power consumption	Operation: 60 W, Stand by: 1 W	Operation: 65 W, Stand by: 1 W
Weight	11.5 lbs (5.1 kg)	13.5 lbs (6.1 kg)
Dimensions	Width: 18-9/16 inches (472 mm) Height: 15-13/16 inches (401 mm) Depth: 8-1/8 inches (207 mm)	Width: 21-1/8 inches (536.5 mm) Height: 17-5/16 inches (439.5 mm) Depth: 8-1/8 inches (207 mm)
Operating temperature	5°C-40°C (41°F-104°F)	
Operating humidity	Less than 80% RH (No condensation)	
Television		
LCD panel (Screen size is approximate.)	19-inch diagonal	22-inch diagonal
Display method	Color TFT LCD	
Number of pixels	1440 (Horizontal) x 900 (Vertical)	1680 (Horizontal) x 1050 (Vertical)
Television system	NTSC standard, ATSC standard (8VSB), QAM	
Receiving channels	VHF: 2-13 UHF: 14-69 CATV: 1-125 (4A, A-5~A-1, A~I, J~W, W+1~W+84)	
Antenna input	VHF/UHF 75 Ω	
Speaker	1-3/16 x 2-13/16 inches (30.5 x 71.1 mm), 8 Ω x 2	
Audio output power	1.5W + 1.5W	
DVD/CD player		
Signal system	NTSC	
Applicable disc	1. DVD (12cm, 8cm) 2. CD (12cm, 8cm)	
Pickup	1-Lens, 2-Beams System	
Input/Output		
S-Video input	(Y) 1.0 V (p-p), 75 Ω, negative sync., Mini DIN 4-pin x 1 (C) 1.0 V (p-p), 75 Ω	
ColorStream video input	(Y) 1.0 V (p-p), 75 Ω, negative sync., pin jack x 1 (PB, PR) 0.7 V (p-p), 75 Ω, pin jack x 2	
Video input	1.0 V (p-p), 75 Ω, negative sync., pin jack x 1	
Audio input	-8dBm, 50 kΩ, negative sync., pin jack (L/R) x 2	
HDMI input	HDMI compliant (type A connector), HDCP compliant, E-EDID compliant Suggested scan rates: 1080i, 480p, 720p HDMI Audio: 2-channel PCM, 32/44.1/48 kHz sampling frequency, 16/20/24 bits per sample	
PC input	MONITOR: Mini-Dsub 15pin x 1, AUDIO: 3.5ø mm Stereo jack x 1	
Digital audio output (Coaxial)	0.5 V (p-p), 75 Ω, pin jack x 1	
Headphone	ø3.5mm stereo mini jack x 1	
Accessories		
Remote control (SE-R0305)	1	
Batteries (R03/AAA)	2	
AC cord	1	
Cleaning cloth	1	
Owner's manual (this booklet)	1	
Quick setup guide (Spanish)	1	

- This model complies with the above specifications.
- Designs and specifications are subject to change without notice.
- This model may not be compatible with features and/or specifications that may be added in the future.

Limited United States Warranty LCD TV/DVD Combination - Depot Repair Warranty

Toshiba America Consumer Products, L.L.C. ("TACP") makes the following limited warranties to original consumers in the United States. THESE LIMITED WARRANTIES EXTEND TO THE ORIGINAL CONSUMER PURCHASER OR ANY PERSON RECEIVING THIS LCD TV/DVD COMBINATION AS A GIFT FROM THE ORIGINAL CONSUMER PURCHASER AND TO NO OTHER PURCHASER OR TRANSFEREE.

LCD TV/DVD COMBINATIONS PURCHASED IN THE U.S.A. AND USED ANYWHERE OUTSIDE OF THE U.S.A., INCLUDING, WITHOUT LIMITATION, CANADA AND MEXICO, ARE NOT COVERED BY THESE WARRANTIES.

LCD TV/DVD COMBINATIONS PURCHASED ANYWHERE OUTSIDE OF THE U.S.A., INCLUDING, WITHOUT LIMITATION, CANADA AND MEXICO, AND USED IN THE U.S.A., ARE NOT COVERED BY THESE WARRANTIES.

Limited One (1) Year Warranty on Parts and Labor

TACP warrants this LCD TV/DVD Combination and its parts against defects in materials or workmanship for a period of one (1) year after the date of original retail purchase. DURING THIS PERIOD, TACP WILL, AT TACP'S OPTION, REPAIR OR REPLACE A DEFECTIVE PART WITH A NEW OR REFURBISHED PART WITHOUT CHARGE TO YOU.

Rental Units

The warranty for LCD TV/DVD Combination rental units begins on the date of the first rental or thirty (30) days after the date of shipment to the rental firm, whichever comes first.

Commercial Units

LCD TV/DVD Combinations sold and used for commercial purposes have a limited warranty for all parts and labor, which warranty begins on the date of original retail purchase and ends on the date that is ninety (90) days thereafter.

Owner's Manual and Product Registration Card

Read this owner's manual thoroughly before operating this LCD TV/DVD Combination.

Complete and mail the enclosed product registration card or register your LCD TV/DVD Combination online at www.tacp.toshiba.com/service as soon as possible. By registering your LCD TV/DVD Combination you will enable TACP to bring you new products specifically designed to meet your needs and help us to contact you in the unlikely event a safety notification is required under the U.S. Consumer Product Safety Act. Failure to complete and return the product registration card does not diminish your warranty rights.

Your Responsibility

THE ABOVE WARRANTIES ARE SUBJECT TO THE FOLLOWING CONDITIONS:

- (1) You must retain your bill of sale or provide other proof of purchase.
- (2) All warranty servicing of this LCD TV/DVD Combination must be made by the Depot Warranty Repair Center specified by the TACP Consumer Solutions Center.
- (3) The warranties from TACP are effective only if the LCD TV/DVD Combination is purchased and operated in the Continental U.S.A. or Puerto Rico.
- (4) Labor service charges for set installation, setup, adjustment of customer controls, and installation or repair of antenna systems are not covered by this warranty. Reception problems caused by inadequate antenna systems are your responsibility.
- (5) Warranties extend only to defects in materials or workmanship as limited above, and do not extend to any LCD TV/DVD Combination or parts that have been lost or discarded by you or to damage to the LCD TV/DVD Combination or parts caused by fires, misuse, accident, Acts of God (such as lightning or fluctuations in electric power), improper installation, improper maintenance, or use in violation of instructions furnished by TACP; use or malfunction through simultaneous use of this LCD TV/DVD Combination and connected equipment; or to units that have been modified or had the serial number removed, altered, defaced, or rendered illegible.

How to Obtain Warranty Services

If, after following all of the operating instructions in this manual and checking the section "Troubleshooting," you find that service is needed:

- (1) For instructions on how to obtain warranty service for your LCD TV/DVD Combination, contact TACP's Consumer Solution Center toll free at 1-800-631-3811.
- (2) You must include a copy or original bill of sale or other proof of purchase along with the entire LCD TV/DVD Combination to the Depot Warranty Repair Center specified by the TACP Consumer Solutions Center. You are responsible for all inbound transportation and insurance charges for the LCD TV/DVD Combination to the Depot Warranty Repair Center specified by the TACP Consumer Solutions Center.

For additional information, visit TACP's website:
www.tacp.toshiba.com

ALL WARRANTIES IMPLIED BY THE LAW OF ANY STATE OF THE U.S.A., INCLUDING THE IMPLIED WARRANTIES OF MERCHANTABILITY AND FITNESS FOR A PARTICULAR PURPOSE, ARE EXPRESSLY LIMITED TO THE DURATION OF THE LIMITED WARRANTIES SET FORTH ABOVE. WITH THE EXCEPTION OF ANY WARRANTIES IMPLIED BY THE LAW OF ANY STATE OF THE U.S.A. AS HEREBY LIMITED, THE FOREGOING WARRANTY IS EXCLUSIVE AND IN LIEU OF ALL OTHER WARRANTIES, GUARANTEES, AGREEMENTS, AND SIMILAR OBLIGATIONS OF TACP WITH RESPECT TO THE REPAIR OR REPLACEMENT OF ANY PARTS. IN NO EVENT SHALL TACP BE LIABLE FOR CONSEQUENTIAL OR INCIDENTAL DAMAGES (INCLUDING, BUT NOT LIMITED TO, LOST PROFITS, BUSINESS INTERRUPTION, OR MODIFICATION OR ERASURE OF RECORDED DATA CAUSED BY USE, MISUSE OR INABILITY TO USE THIS LCD TV/DVD COMBINATION).

No person, agent, distributor, dealer, or company is authorized to change, modify, or extend the terms of these warranties in any manner whatsoever. The time within which an action must be commenced to enforce any obligation of TACP arising under the warranty or under any statute or law of the United States or any state thereof is hereby limited to ninety (90) days from the date you discover, or should have discovered, the defect. This limitation does not apply to implied warranties arising under state law.

THIS WARRANTY GIVES YOU SPECIFIC LEGAL RIGHTS AND YOU MAY ALSO HAVE OTHER RIGHTS WHICH MAY VARY FROM STATE TO STATE IN THE U.S.A. SOME STATES OF THE U.S.A. DO NOT ALLOW LIMITATIONS ON HOW LONG AN IMPLIED WARRANTY LASTS, WHEN AN ACTION MAY BE BROUGHT, OR THE EXCLUSION OR LIMITATION OF INCIDENTAL OR CONSEQUENTIAL DAMAGES, SO THE ABOVE PROVISIONS MAY NOT APPLY TO YOU UNDER SUCH CIRCUMSTANCES.

TOSHIBA

ColorStream is registered trademark of Toshiba America Consumer Products, L.L.C.



J50S0101A SH 08/02

Printed in Thailand