

TOSHIBA

REGZA

Owner's Manual

Integrated High Definition LCD Television



42LX177

46LX177

52LX177

57LX177

For an overview of steps for setting up your new TV, see page 10.

Note: To display a High Definition picture, the TV must be receiving a High Definition signal (such as an over-the-air High Definition TV broadcast, a High Definition digital cable program, or a High Definition digital satellite program). For details, please contact your TV antenna installer, cable provider, or satellite provider.

Owner's Record

The model number and serial number are on the back of your TV. Record these numbers in the spaces below. Refer to these numbers whenever you communicate with your Toshiba dealer about this TV.

Model number:

Serial number:

Dear Customer,

Thank you for purchasing this Toshiba LCD TV. This manual will help you use the many exciting features of your new LCD TV. **Before operating your LCD TV, please read this manual completely, and keep it nearby for future reference.**

Safety Precautions

WARNING: TO REDUCE THE RISK OF FIRE OR ELECTRIC SHOCK, DO NOT EXPOSE THIS APPLIANCE TO RAIN OR MOISTURE.

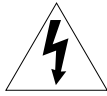

WARNING
RISK OF ELECTRIC SHOCK
DO NOT OPEN.



WARNING: TO REDUCE THE RISK OF ELECTRIC SHOCK, DO NOT REMOVE COVER (OR BACK). NO USER-SERVICEABLE PARTS INSIDE. REFER SERVICING TO QUALIFIED SERVICE PERSONNEL.

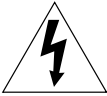

The lightning flash with arrowhead symbol, within an equilateral triangle, is intended to alert the user to the presence of uninsulated "dangerous voltage" within the product's enclosure that may be of sufficient magnitude to constitute a risk of electric shock to persons.



The exclamation point within an equilateral triangle is intended to alert the user to the presence of important operating and maintenance (servicing) instructions in the literature accompanying the appliance.

WARNING

To prevent injury, this apparatus must be securely attached to the floor/wall in accordance with the installation instructions. See item 20 on page 3.

WARNING: If you decide to wall mount this television, always use a UL Listed wall bracket appropriate for the size and weight of this television. The use of any wall bracket other than a UL Listed wall bracket appropriate for the size and weight of this television for wall mounting this television could result in serious bodily injury and/or property damage. See "Removing the Pedestal Stand" (page 5).

NOTE TO CATV INSTALLERS

This is a reminder to call the CATV system installer's attention to Article 820-40 of the U.S. NEC, which provides guidelines for proper grounding and, in particular, specifies that the cable ground shall be connected to the grounding system of the building, as close to the point of cable entry as practical. For additional antenna grounding information, see items 27 and 28 on page 4.

Child Safety

It Makes A Difference Where Your TV Stands



Congratulations on your purchase! As you enjoy your new TV, keep these safety tips in mind:

The Issue

- If you are like most consumers, you have a TV in your home. Many homes, in fact, have more than one TV.
- The home theater entertainment experience is a growing trend, and larger TVs are popular purchases; however, they are not always supported on the proper TV stands.
- Sometimes TVs are improperly secured or inappropriately situated on dressers, bookcases, shelves, desks, audio speakers, chests, or carts. As a result, TVs may fall over, causing unnecessary injury.



Toshiba Cares!

- The consumer electronics industry is committed to making home entertainment enjoyable and safe.
- The Consumer Electronics Association formed the Home Entertainment Support Safety Committee, comprised of TV and consumer electronics furniture manufacturers, to advocate children's safety and educate consumers and their families about television safety.

Tune Into Safety

- One size does NOT fit all! Use appropriate furniture large enough to support the weight of your TV (and other electronic components).
- Use appropriate angle braces, straps, and anchors to secure your furniture to the wall (but never screw anything directly into the TV).
- Carefully read and understand the other enclosed instructions for proper use of this product.
- Do not allow children to climb on or play with furniture and TVs.
- Avoid placing any item on top of your TV (such as a VCR, remote control, or toy) that a curious child may reach for.
- Remember that children can become excited while watching a program and can potentially push or pull a TV over.
- Share our safety message about this hidden hazard of the home with your family and friends. Thank you!



2500 Wilson Blvd.
Arlington, VA 22201 U.S.A.
www.CE.org

CEA is the Sponsor, Producer and
Manager of the International CES®

Important Safety Instructions

- 1) **Read these instructions.**
- 2) **Keep these instructions.**
- 3) **Heed all warnings.**
- 4) **Follow all instructions.**



- 5) **Do not use this apparatus near water.**
- 6) **Clean only with dry cloth.**
- 7) **Do not block any ventilation openings.** Install in accordance with the manufacturer's instructions.
- 8) **Do not install near any heat sources** such as radiators, heat registers, stoves, or other apparatus (including amplifiers) that produce heat.

- 9) **Do not defeat the safety purpose of the polarized or grounding type plug.** A polarized plug has two blades with one wider than the other.

A grounding type plug has two blades and a third grounding prong. The wide blade or the third prong are provided for your safety. If the provided plug does not fit into your outlet, consult an electrician for replacement of the obsolete outlet.

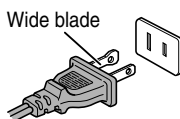

- 10) **Protect the power cord** from being walked on or pinched, particularly at plugs, convenience receptacles, and the point where they exit from the apparatus.

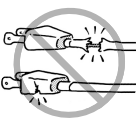

- 11) **Only use attachments/accessories specified by the manufacturer.**

- 12) **Use only with the cart, stand, tripod, bracket, or table specified by the manufacturer, or sold with the apparatus.** When a cart is used, use caution when moving the cart/apparatus combination to avoid injury from tip-over.



- 13) **Unplug this apparatus during lightning storms or when unused for long periods of time.**

- 14) **Refer all servicing to qualified service personnel.** Servicing is required when the apparatus has been damaged in any way, such as power-supply cord or plug is damaged, liquid has been spilled or objects have fallen into the apparatus, the apparatus has been exposed to rain or moisture, does not operate normally, or has been dropped.

Additional Safety Precautions

- 14a) **CAUTION:** If the TV is dropped and the cabinet or enclosure surface has been damaged or the TV does not operate normally, take the following precautions:
 - ALWAYS turn off the TV and unplug the power cord to avoid possible electric shock or fire.
 - NEVER allow your body to come in contact with any broken glass or liquid from the damaged television. The LCD panel inside the TV contains glass and a toxic liquid. If the liquid comes in contact with your mouth or eyes, or your skin is cut by broken glass, rinse the affected area thoroughly with water and consult your doctor.
 - ALWAYS contact a service technician to inspect the TV any time it has been damaged or dropped.

- 15) **CAUTION:**

- To reduce the risk of electric shock, do not use the polarized plug with an extension cord, receptacle, or other outlet unless the blades can be inserted completely to prevent blade exposure.
- To prevent electric shock, match wide blade of plug to wide slot; fully insert.

- 16) **WARNING:**

To prevent the spread of fire, keep candles or other open flames away from this product at all times.

Installation, Care, and Service

Installation

Follow these recommendations and precautions and heed all warnings when installing your TV:

- 17) Never modify this equipment. Changes or modifications may void: a) the warranty, and b) the user's authority to operate this equipment under the rules of the Federal Communications Commission.

- 18) **DANGER: RISK OF SERIOUS PERSONAL INJURY, DEATH, OR EQUIPMENT DAMAGE!**



Never place the TV on an unstable cart, stand, or table. The TV may fall, causing serious personal injury, death, or serious damage to the TV.



- 19) To avoid damage to this product, never place or store the TV in direct sunlight; hot, humid areas; or areas subject to excessive dust or vibration.

- 20) Always place the TV on the floor or a sturdy, level, stable surface that can support the weight of the unit. To secure the TV, use a sturdy tie from the hooks on the rear of the TV pedestal to a wall, pillar, or other immovable structure. Make sure the tie is tight, secure, and parallel to the floor.

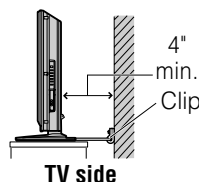

Sturdy tie (as short as possible)

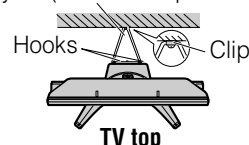

- 21) The apparatus shall not be exposed to dripping or splashing and that no objects filled with liquids, such as vases, shall be placed on the apparatus.

- 22) Never block or cover the slots or openings in the TV cabinet back, bottom, and sides. Never place the TV:

- on a bed, sofa, rug, or similar surface;
- too close to drapes, curtains, or walls; or
- in a confined space such as a bookcase, built-in cabinet, or any other place with poor ventilation.

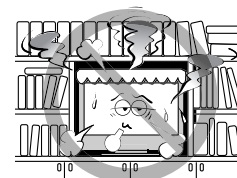

The slots and openings are provided to protect the TV from overheating and to help maintain reliable operation of the TV. Leave a space of at least 4 (four) inches around the TV.

(continued)

- 23) Always place the back of the television at least four (4) inches away from any vertical surface (such as a wall) to allow proper ventilation.
- 24) Never allow anything to rest on or roll over the power cord, and never place the TV where the power cord is subject to wear or abuse.
- 25) Never overload wall outlets and extension cords.
- 26) Always operate this equipment from a 120 VAC, 60 Hz power source only.
- 27) Always make sure the antenna system is properly grounded to provide adequate protection against voltage surges and built-up static charges (see Section 810 of the National Electric Code).

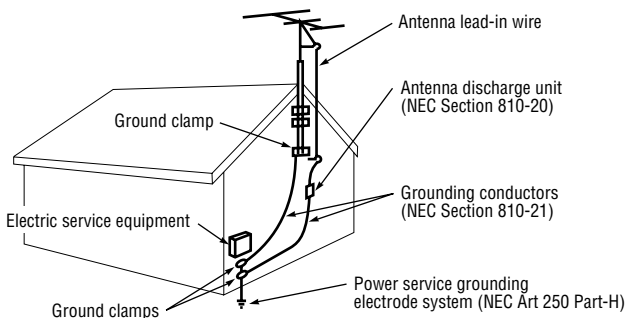



- 28)  **DANGER: RISK OF SERIOUS PERSONAL INJURY OR DEATH!**
- Use extreme care to make sure you are never in a position where your body (or any item you are in contact with, such as a ladder or screwdriver) can accidentally touch overhead power lines. Never locate the antenna near overhead power lines or other electrical circuits.
 - Never attempt to install any of the following during lightning activity: a) an antenna system; or b) cables, wires, or any home theater component connected to an antenna or phone system.



Care

For better performance and safer operation of your TOSHIBA TV, follow these recommendations and precautions:

- 29) If you use the TV in a room whose temperature is 32 °F (0 °C) or below, the picture brightness may vary until the LCD warms up. This is not a sign of malfunction.
- 30) Always unplug the TV before cleaning. Gently wipe the display panel surface (the TV screen) using a dry, soft cloth only (cotton, flannel, etc.). A hard cloth may damage the surface of the panel. Avoid contact with alcohol, thinner, benzene, acidic or alkaline solvent cleaners, abrasive cleaners, or chemical cloths, which may damage the surface. Never spray volatile compounds such as insecticide on the cabinet. Such products may damage or discolor the cabinet.





- 31)  **WARNING: RISK OF ELECTRIC SHOCK!** 
Never spill liquids or push objects of any kind into the TV cabinet slots.
- 32) While it is thundering, do not touch the connecting cables or apparatus.
 - 33) For added protection of your TV from lightning and power surges, always unplug the power cord and disconnect the antenna from the TV if you leave the TV unattended or unused for long periods of time.
 - 34) During normal use, the TV may make occasional snapping or popping sounds. This is normal, especially when the unit is being turned on or off. If these sounds become frequent or continuous, unplug the power cord and contact a Toshiba Authorized Service Center.

- 35)  **WARNING: RISK OF SERIOUS PERSONAL INJURY OR EQUIPMENT DAMAGE!** 
Never strike the screen with a sharp or heavy object.

- 36) • The LCD screen of this product can be damaged by ultraviolet radiation from the sun. When selecting a location for the television, avoid locations where the screen may be exposed to direct sunlight, such as in front of a window.
- Never touch, press, or place anything on the LCD screen. These actions will damage the LCD screen. If you need to clean the LCD screen, follow the instructions in item 30 on this page.

Service

- 37)  **WARNING: RISK OF ELECTRIC SHOCK!** 
Never attempt to service the TV yourself. Opening and removing the covers may expose you to dangerous voltage or other hazards. Failure to follow this WARNING may result in death or serious injury. Refer all servicing not specified in this manual to a Toshiba Authorized Service Center.

- 38) If you have the TV serviced:
 - Ask the service technician to use only replacement parts specified by the manufacturer.
 - Upon completion of service, ask the service technician to perform routine safety checks to determine that the TV is in safe operating condition.

- 39) The cold cathode fluorescent lamp in the LCD panel contains a small amount of mercury. When the TV reaches the end of its useful life, dispose of the used TV by the approved method for your area, or ask a qualified service technician to properly dispose of the TV.

 **Note:** The lamp(s) inside this product contain mercury. Disposal may be regulated due to environmental considerations. For disposal or recycling information, contact your local authorities or the Electronics Industries Alliance (www.eiae.org).

Choosing a location for your LCD TV

To Display your LCD TV on the included Pedestal Stand:

Observe the following safety precautions:

- 1) Read and Follow the pedestal assembly instructions included with the pedestal.

CAUTION: Before beginning pedestal assembly, carefully lay the front of the LCD Panel face down on a flat, cushioned surface such as a quilt or blanket. Leave the bottom of the unit protruding over the edge of the surface and assemble the pedestal as indicated below.

Note: Extreme care should always be used when attaching the pedestal stand to avoid damage to the LCD panel.

- 2) Place the TV on a sturdy, level surface that can support the weight of the TV.
- 3) Be sure to secure the TV to a wall, pillar, surface, or other immovable structure. To secure the TV in this manner, use the included strap located at the rear of the pedestal stand. (see item 20, page 3).

To Display your LCD TV using a Wall Bracket:

If you decide to wall mount your LCD TV, always use a UL-listed wall bracket appropriate for the size and weight of the LCD TV (see page 2) :

- 1) **CAUTION:** Two people are required for installation.
- 2) Unplug and remove any cables and/or other component connectors from the rear of the TV.
- 3) Follow the instructions provided with your wall bracket. Before proceeding, make sure the appropriate bracket(s) are attached to the wall and the back of the TV as described in the instructions provided with the wall bracket.
- 4) After attaching the appropriate bracket(s) to the wall and the back of the TV, remove the pedestal stand from the TV as described below.

Removing the Pedestal Stand

- 1) Carefully lay the front of the unit face down on a flat, cushioned surface such as a quilt or blanket. Leave the stand protruding over the edge of the surface.

Note: Extreme care should always be used when removing the pedestal stand to avoid damage to the LCD panel.

- 2) Remove the jack pack cover on the back of the TV to expose the pedestal stand screws. The jack pack cover can be removed without tools.
- 3) Remove the five screws shown in the diagram below. This will allow removal of the pedestal stand.
- 4) Once you have removed all five screws holding the pedestal stand in place, remove the pedestal stand from the TV by sliding the pedestal stand away from the TV.

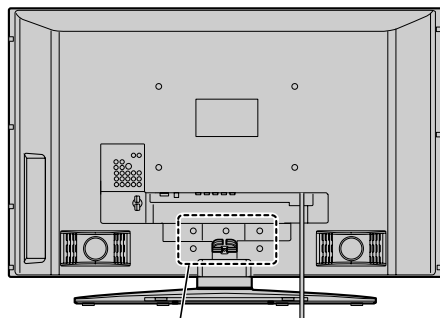

Five screws

FCC Declaration of Conformity Compliance Statement (Part 15):

The **Toshiba 42LX177, 46LX177, 52LX177, and 57LX177 Televisions** comply with Part 15 of the FCC rules.

Operation is subject to the following two conditions: (1) this device may not cause harmful interference, and (2) this device must accept any interference received, including interference that may cause undesired operation.

The party responsible for compliance to these rules is:

Toshiba America Consumer Products, L.L.C.

82 Totowa Rd. Wayne, NJ 07470.

Ph: 1-800-631-3811

Note: *This equipment has been tested and found to comply with the limits for a Class B digital device, pursuant to Part 15 of the FCC rules. These limits are designed to provide reasonable protection against harmful interference in a residential installation. This equipment generates, uses, and can radiate radio frequency energy and, if not installed and used in accordance with the instructions, may cause harmful interference to radio communications. However, there is no guarantee that interference will not occur in a particular installation. If this equipment does cause harmful interference to radio or television reception, which can be determined by removing and applying power to the equipment, the user is encouraged to try to correct the interference by one or more of the following measures:*

- Reorient or relocate the receiving antenna.
- Increase the separation between the equipment and the receiver.
- Connect the equipment into an outlet on a circuit different from that to which the receiver is connected.
- Consult the dealer or an experienced radio/TV technician for help.

Caution: *Changes or modifications to this equipment not expressly approved by Toshiba could void the user's authority to operate this equipment.*

Important notes about your LCD TV

The following symptoms are technical limitations of LCD Display technology and are not an indication of malfunction; therefore, Toshiba is not responsible for perceived issues resulting from these symptoms.

- 1) An afterimage (ghost) may appear on the screen if a fixed, non-moving image is displayed for a long period of time. The afterimage is not permanent and will disappear in a short period of time.
- 2) The LCD panel contained in this TV is manufactured using an extremely high level of precision technology; however, there may be an occasional pixel (dot of light) that does not operate properly (does not light, remains constantly lit, etc.). This is a structural property of LCD technology, is not a sign of malfunction, and is not covered under your warranty. Such pixels are not visible when the picture is viewed from a normal viewing distance.

Note: *Interactive video games that involve shooting a "gun" type of joystick at an on-screen target may not work with this TV.*

Trademark Information

- WOW, TruSurround, SRS and  symbol are trademarks of SRS Labs, Inc. WOW and TruSurround technologies are incorporated under license from SRS Labs, Inc.
- Manufactured under license from Dolby Laboratories. Dolby, Pro Logic and the double-D symbol are registered trademarks of Dolby Laboratories.
- HDMI, the HDMI logo and High-Definition Multimedia Interface are trademarks or registered trademarks of HDMI Licensing LLC.
- Deep Color is trademark of HDMI Licensing LLC.

Contents

Important Safety Instructions	3
Installation, Care, and Service	3
Chapter 1: Introduction	9
Welcome to Toshiba	9
Features of your new TV	9
Overview of steps for installing, setting up, and using your new TV	10
TV front and side panel controls and connections	11
TV back panel connections	12
Chapter 2: Connecting your TV	14
Overview of cable types	14
About the connection illustrations	14
Connecting a VCR and antenna or Cable TV (no Cable box)	15
Connecting a VCR with S-video and a cable box	16
Connecting a DVD player with ColorStream® (component video), a VCR, and a satellite receiver. . . .	17
Connecting a device to the IR OUT infrared terminal using the IR blaster cable for IR pass-through device control	18
Connecting an IR receiver/repeater control system to the IR IN infrared terminal	19
Connecting a camcorder	19
Connecting an HDMI™ or DVI device to the HDMI input	20
CE-Link connection	21
Connecting a digital audio system	22
Connecting an audio system	22
Connecting a personal computer (PC)	23
Connecting a home network	24
Chapter 3: Using the remote control	26
Installing the remote control batteries	26
Remote control effective range	26
Learning about the remote control	27
Remote Control functional key chart	29
Using the remote control to operate your other devices	31
Programming the remote control to operate your other devices	31
Device code setup	31
Searching and sampling the code of a device (8500)	32
Using the volume lock feature (8000)	32
Operational feature reset (8900)	32
Multi-brand remote control device codes	33
Chapter 4: Menu layout and navigation	40
Main menu layout	40
Setup/Installation menu layout	41
THINC™ menu	41
Navigating the menu system	42
Chapter 5: Setting up your TV	43
Setting the Demo Mode	43
Selecting the menu language	43
Configuring the antenna input source for the ANT terminal	44
Programming channels into the TV's channel memory	44
Programming channels automatically	44
Manually adding and deleting channels in the channel memory	45
Setting the Auto Input feature	46
Labeling channels	47
Setting the HDMI™ audio mode	48
Viewing the digital signal meter	49
Viewing the system status	49
Selecting the Power-On Mode	50
Selecting the Demo Mode	50
Chapter 6: Using the TV's features	51
Selecting the video input source to view	51
Labeling the video input sources	52
Tuning channels	53
Tuning channels using the Channel Browser™	53
Tuning to the next programmed channel	55
Tuning to a specific channel (programmed or unprogrammed)	55
Switching between two channels using Channel Return	55
Switching between two channels using SurfLock™	55
Selecting the picture size	56
Scrolling the TheaterWide® picture (TheaterWide 2 and 3 only)	58
Using the auto aspect ratio feature	58
Using the FREEZE feature	59
Using the POP features	59
Using the POP double-window feature	59
Selecting the POP window audio out	60
Adjusting the picture	60
Selecting the picture mode	60
Adjusting the picture quality	61
Using the TheaterLock™ feature	61
Using the closed caption mode	62
Base closed captions	62
Digital CC Settings	63
CC Selector	63
Using the Closed Caption button on the remote control	63
Adjusting the audio	64
Muting the sound	64
Using the digital audio selector	64
Selecting stereo/SAP broadcasts	64
Adjusting the audio quality	65
Using the StableSound® feature	65
Turning off the built-in speakers	66
Selecting the optical audio output format	66
Using the Dolby® Digital Dynamic Range Control feature	66
Using the Locks menu	67
Entering the PIN code	67
If you cannot remember your PIN code	67
Changing your PIN code	67
Blocking TV programs and movies by rating (V-Chip)	68
Downloading an additional rating system for blocking TV programs and movies	68
Blocking channels	69
Unlocking programs temporarily	70
Using the input lock feature	70
Using the GameTimer®	71
Using the control panel lock feature	71
Using the PC settings feature	72
Setting the PC Audio	72
Setting the sleep timer	73
Using CE-Link	73
CE-Link playback device (HD DVD player, etc.) control	73
CE-Link input source selection	74
Audio Receiver VOLUME and MUTE control	74
Other CE-Link functions	74
Using the HDMI settings feature	75

(continued)

Displaying TV status information	76
Understanding the auto power off feature	76
Understanding the last mode memory feature	76
Chapter 7: Using the TV's advanced features	77
Using the advanced picture settings features	77
Using dynamic contrast	77
Using the static gamma feature	77
Selecting the color temperature	78
Using the Vertical Edge Enhancer feature	78
Selecting the cinema mode (480i and 1080i signals)	79
Using the ClearFrame™ feature	79
Using the Film Stabilization feature	80
Using CableClear® digital noise reduction	80
Using MPEG noise reduction	81
Using the ColorMaster™ Pro feature	81
Using xvYCC Selection feature	83
Using the Game Mode feature	83
Using the advanced audio settings features	84
Using the SRS WOW™ surround sound feature	84
Using the virtual surround sound feature (Dolby® Virtual and SRS TruSurround™)	84
Using the Help feature	85
Chapter 8: Using the THINC™ home network feature	87
A. Connecting the TV to your home network	87
B. Setting up the network address	88
Automatically setting up the network address	88
Manually setting up the network address	89
Resetting the network address	90
C. Setting up file sharing on your PC	90
Compatible operating systems	90
Setting up file sharing on a PC with Microsoft® Windows® XP Service Pack 2 or higher	90
Setting up file sharing on a PC with Microsoft® Windows® 2000	92
D. Setting up file sharing on the TV	93
Using the software keyboard	94
About the Software Upgrade feature	94
E. Viewing/playing shared files on the TV	95
Media specifications	95
Using the Picture Viewer	96
Using the Audio Player	98
F. Setting up the Personal E-mail feature	99
Required information and services	99
Setting up Personal E-mail	99
Description of fields in the “E-mail Account Setup” window	101
G. Using the Personal E-mail feature	102
Unread E-mail Notification	102
E-mail Inbox	102
Read View	103
Chapter 9: Troubleshooting	104
General troubleshooting	104
Home network troubleshooting	106
LED indications	108
Chapter 10: Appendix	109
Specifications	109
Limited United States Warranty for LCD Televisions 26” and Larger	111
Limited Canadian Warranty for Toshiba Brand Flat Panel Televisions	112
Index	115

Welcome to Toshiba

Thank you for purchasing this Toshiba LCD TV, one of the most innovative LCD TVs on the market. This digital television is capable of receiving analog basic, digital basic and digital premium cable television programming by direct connection to a cable system providing such programming. A security card provided by your cable operator is required to view encrypted digital programming. Certain advanced and interactive digital cable services such as video-on-demand, a cable operator's enhanced program guide and data-enhanced television services may require the use of a set-top box. For more information call your local cable operator.

Features of your new TV

The following are just a few of the many exciting features of your new Toshiba widescreen, integrated HD, LCD TV:

- **Integrated digital tuning (8VSB ATSC and QAM)** eliminates the need for a separate digital converter set-top box (in most cases).
- **ClearFrame™** new 120Hz anti-blur feature (☞ page 79)
- **1080p** output resolution.
- **Three HDMI™** digital, high-definition multimedia interfaces capable of supporting up to 1080p sources (☞ page 20).
- **HDMI new capabilities**
 - Lip-Sync Latency** feature activates an auto audio/video display timing adjustment function that allows HDMI source devices to accurately perform synchronization automatically.
 - Deep Color** feature allows to HDMI source to increase available colors bits within the boundaries defined by the RGB or YCbCr color space.
 - xvYCC** feature expands the acceptable color range (limits) in the HDMI signals, then allows sending wider color signals from HDMI source.
- **Two sets of ColorStream® HD** high-resolution component video inputs (☞ page 17).
- **SRS WOW™** and **Dolby Virtual** and **SRS TruSurround™** audio technologies (☞ page 84).
- **Digital Audio Out** optical audio connection with Dolby® Digital optical output format (☞ page 66).
- **CableClear®** digital picture noise reduction (☞ page 80).
- **Double-window POP** feature (☞ page 59).
- **PC IN (Analog RGB)** computer terminal (☞ page 23).
- **Ethernet (RJ-45) (THINC™) port** for connecting the TV to a home network to enable file sharing (JPEG, MP3), and use of personal e-mail (☞ Chapter 8).
- **Channel Labeling** allows you to put the Call Letters (e.g. ABC, HBO, etc.) on the screen along with the station numbers, so you always know what you're watching (☞ page 47).
- **IR IN and IR OUT** infrared terminals using the IR blaster cable for IR pass-through device control (☞ pages 14, 18, and 19).
- **ColorMaster™ Pro** allows you to adjust the TV's standard colors and create up to three additional custom colors. (☞ page 81).
- **CE-Link** allows control of external devices from the TV via HDMI connection (☞ page 73).
- **The Personal E-mail** feature allows you to access your e-mail server through the TV (☞ page 99).
- **Help** feature allows you to research and analyze commonly misunderstood behavior directly from your TV (☞ page 85).

Overview of steps for installing, setting up, and using your new TV

Follow these steps to set up your TV and begin using its many exciting features.

- 1** Carefully read the important safety, installation, care, and service information. Keep this manual for future reference.
- 2** Observe the following when choosing a location for the TV:
 - Read “Important notes about your LCD TV” (🔍 page 6).
 - Place the TV on the floor or a sturdy, level, stable surface that can support the weight of the unit. Secure the TV to a wall, pillar, or other immovable structure (🔍 page 3).
 - Place the TV in a location where light does not reflect on the screen.
 - Place the TV far enough from walls and other objects to allow proper ventilation. Inadequate ventilation may cause overheating, which will damage the TV. **THIS TYPE OF DAMAGE IS NOT COVERED UNDER THE TOSHIBA WARRANTY.**
- 3** Do not plug in any power cords until **AFTER** you have connected all cables and devices to your TV.
- 4** **BEFORE** connecting cables or devices to the TV, learn the functions of the TV’s connections and controls (🔍 pages 11–13).
- 5** Connect your other electronic device(s) to the TV (🔍 pages 14–25).
- 6** Install the batteries in the remote control (🔍 page 26).
- 7** See “Learning about the remote control” (🔍 page 27) for an overview of the buttons on the remote control.
- 8** Program the remote control to operate your other device(s) (🔍 pages 31–39).
- 9** **AFTER** connecting all cables and devices, plug in the power cords for your TV and other devices. The yellow LED will blink until the TV goes into standby mode. When the TV is in standby mode, press **POWER** on the TV control panel or remote control to turn on the TV. If the TV stops responding to the controls on the remote control or TV control panel and you cannot turn the TV off or on, press and hold the **POWER** button for 5 seconds to reset the TV.

Note: After you turn on the TV, the Menu Language selection and Demo Mode selection menus appear automatically by default. You can turn off the On-Screen demonstration mode by selecting the Demo Mode Normal (🔍 page 43).

- 10** See “Menu layout and navigation” for a quick overview of navigating the TV’s menu system (🔍 page 40).
- 11** Programming channels into the TV’s channel memory (🔍 page 44).
- 12** For details on using the TV’s features, see Chapters 6 and 7.
- 13** For details on connecting the TV to a home network to enable file sharing and personal e-mail, see Chapter 8.
- 14** For help, refer to the Troubleshooting Guide, Chapter 9.
- 15** For technical specifications and warranty information, see Chapter 10.
- 16** Enjoy your new TV!

TV front and side panel controls and connections

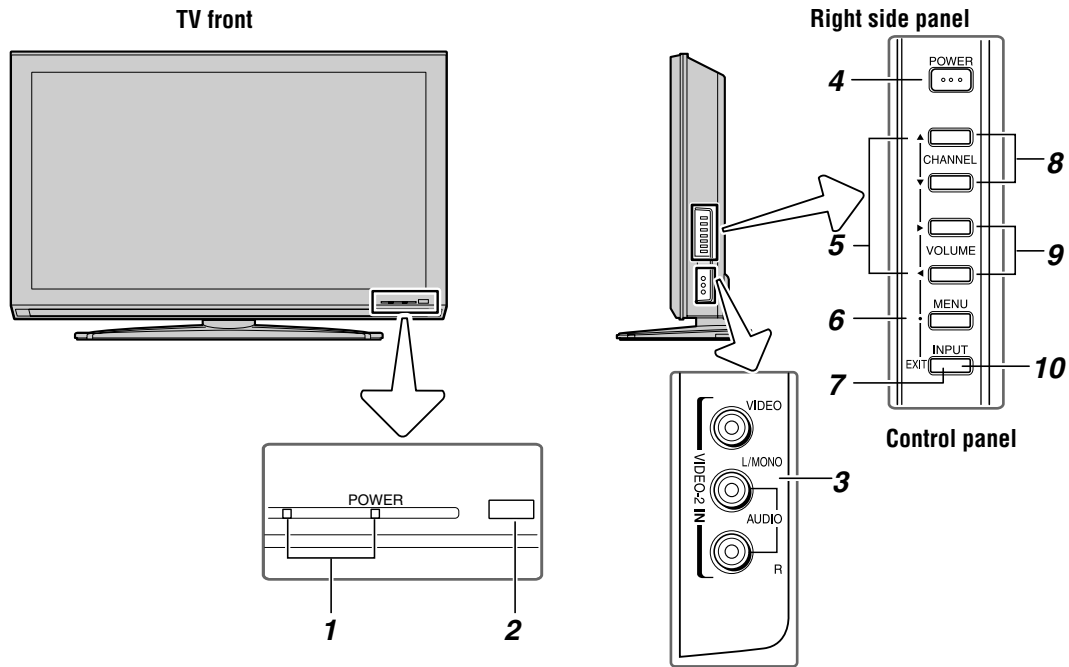

1 Green and Yellow LEDs

Green = Power indicator

Yellow = Power-On Mode indicator (☞ “Selecting the Power-On Mode” on page 50)

See “LED indications” on page 108 for additional information.

2 Remote sensor — Point the remote control toward this remote sensor (☞ “Remote control effective range” on page 26).

3 VIDEO-2 IN — The side panel A/V connections are referred to as “**VIDEO 2**” and include standard A/V connections.

4 POWER — Press to turn the TV on and off.
If the TV stops responding to the controls on the remote control or TV control panel and you cannot turn off the TV, press and hold the **POWER** button on the TV control panel for 5 or more seconds to reset the TV.

5 ARROWS ▲▼◀▶ — When a menu is on-screen, these buttons function as up/down/left/right menu navigation buttons.

6 MENU (ENTER) — Press to access the menu system (☞ pages 40–41). When a menu is on-screen, the **MENU** button on the TV’s control panel functions as the **ENTER** button.

7 EXIT — Press to instantly close an on-screen menu.

8 CHANNEL ▲▼ — When no menu is on-screen, these buttons change the channel (programmed channels only; ☞ page 44).

9 VOLUME ◀▶ — These buttons adjust the volume level.

10 INPUT — Repeatedly press to change the source you are viewing (**ANT, VIDEO 1, VIDEO 2, ColorStream HD1, ColorStream HD2, HDMI 1, HDMI 2, HDMI 3, PC**) (☞ page 51).

TV back panel connections

For an explanation of cable types and connections, see pages 14–23.

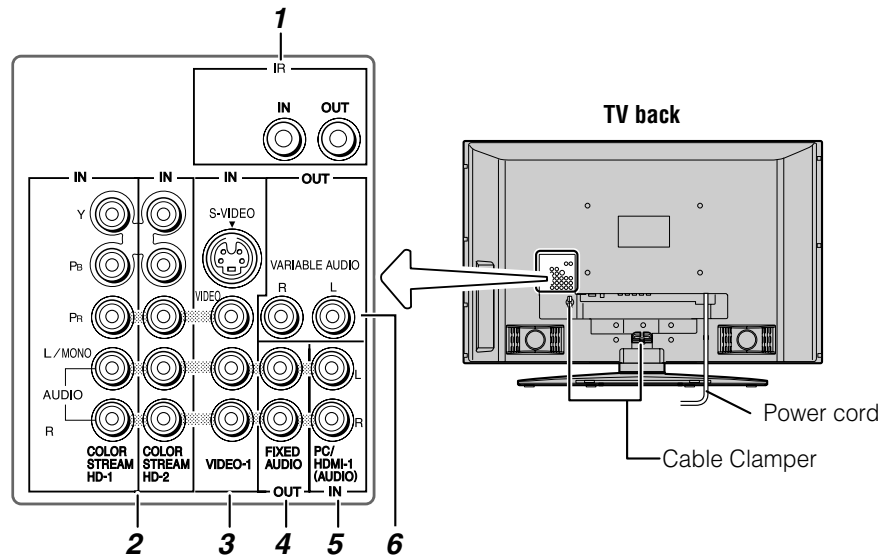

1 IR OUT — For controlling infrared remote-controlled devices through the TV. You can connect up to two devices with an optical IR blaster cable (see pages 14 and 18), and then control the devices using the TV's IR pass-through features.

IR IN — For connecting to IR OUT on other devices (see page 19).

2 ColorStream® HD-1 and ColorStream® HD-2 — Two sets of ColorStream® high-definition component video inputs (with standard stereo audio inputs) for connecting devices with component video output, such as a Toshiba DVD player with ColorStream®.

Note: Component video cables carry only video information; separate audio cables are required for a complete connection.

3 VIDEO-1 IN — Standard (composite) video and standard audio inputs plus optional S-video inputs for connecting devices with composite video or S-video output.

Note: Standard (composite) video and S-video cables carry only video information; separate audio cables are required for a complete connection.

4 Fixed Audio OUT — Analog audio outputs for connecting an audio amplifier. When the POP double-window is open, the active window sound is output (see page 59).

5 PC/HDMI-1 (AUDIO) IN — PC audio input terminals are shared with HDMI-1 analog audio input terminals, and their use can be configured in the **Audio Setup** menu (see page 72).

6 Variable Audio OUT — Standard analog audio outputs for connecting an analog amplifier with external speakers. When the POP double-window is open, the active window sound is output (see page 60).

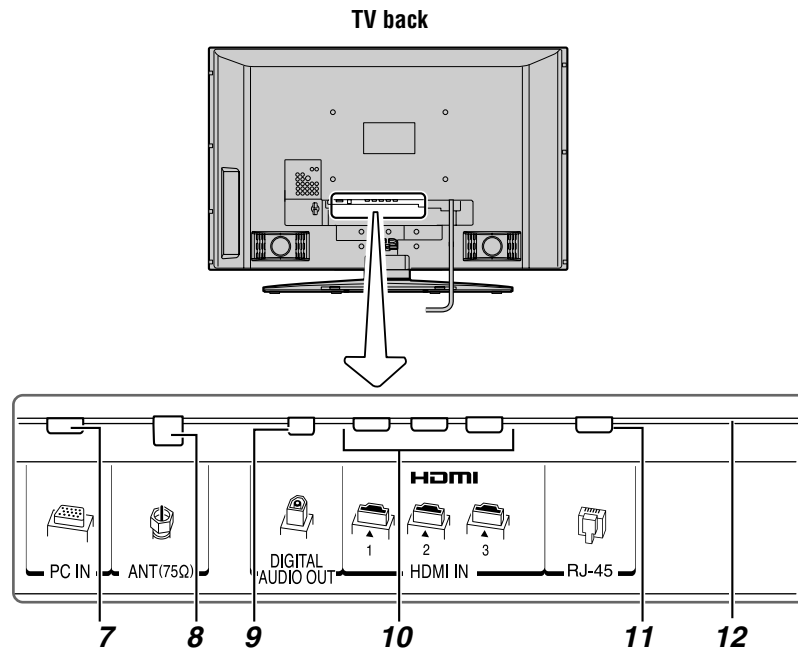

- 7 PC IN** — For use when connecting a personal computer.
- 8 ANT** — Antenna input that supports analog (NTSC) and digital (ATSC) off-air antenna signals and analog and digital Cable TV (QAM) signals.
- 9 Digital Audio OUT** — Optical audio output in Dolby Digital or PCM (pulse-code modulation) format for connecting an external Dolby Digital decoder, amplifier, A/V receiver, or home theater system with optical audio input.
- 10 HDMI™ IN** — High-Definition Multimedia Interface input receives digital audio and uncompressed digital video from an HDMI device or uncompressed digital video from a DVI device. Also see item 5 on previous page. HDMI connection is necessary to receive 1080p signals.

- 11 RJ-45 (Ethernet) (THINC™ system*)** — For connecting the TV to your home network. See boxed note below.

***THINC™ system**
(Toshiba Home Interactive Network Connection)

The RJ-45 (Ethernet) port allows your Toshiba TV to connect to your home network. You can use this revolutionary home entertainment networking system to access MP3 audio files and JPEG picture files that are stored as shared files on a networked PC and play/display them on your TV.

You also can play your shared MP3 audio files through a connected audio system.

Personal e-mail is also enabled with the THINC system. See Chapter 8 for details. Also see pages 24 and 25.

- 12 Service port** — For service use only. Used for updating the television's firmware.

HDMI, the HDMI logo and High-Definition Multimedia Interface are trademarks or registered trademarks of HDMI Licensing LLC. Manufactured under license from Dolby Laboratories. Dolby, Pro Logic, and the double-D symbol are registered trademarks of Dolby Laboratories.

Chapter 2: Connecting your TV

Overview of cable types

Cables can be purchased from most stores that sell audio/video devices. Before purchasing any cables, be sure of connector types required by your devices and the length of each cable.

Coaxial (F-type) cable



Coaxial (F-type) cable is used for connecting your antenna, cable TV service, and/or cable converter box to the **ANT** input on your TV.

Standard A/V cables (red/white/yellow)

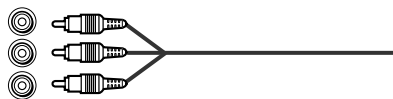

Standard A/V cables (composite video) usually come in sets of three, and are for use with video devices with analog audio and composite video output. These cables (and the related inputs on your TV) are typically color-coded according to use: yellow for video, red for stereo right audio, and white for stereo left (or mono) audio.

S-video cable



S-video cable is for use with video devices with S-video output. Separate audio cables are required for a complete connection.

Note: An S-video cable provides better picture performance than a composite video cable. If you connect an S-video cable, be sure to disconnect the standard (composite) video cable or the picture performance will be unacceptable.

Component video cables (red/green/blue)

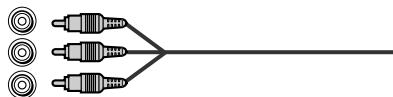

Component video cables come in sets of three and are for use with video devices with component video output. (ColorStream® is Toshiba's brand of component video.) These cables are typically color-coded red, green, and blue. Separate audio cables are required for a complete connection.

Note: Component video cables provide better picture performance than a standard (composite) video or S-video cable.

HDMI™ cable (with HDMI Logo “HDMI”)



HDMI (High-Definition Multimedia Interface) cable is for use with devices with an HDMI output. An HDMI cable delivers digital audio and video in its native format. This cable carries both video and audio information; therefore, separate audio cables are not required for a complete HDMI device connection (➤ page 20 and page 23).

Note: HDMI cable provides better picture performance than a standard (composite) video or S-video cable.

Dual-wand IR blaster cable



Dual-wand IR blaster cable is for use with video devices with IR (infrared) remote control. This cable can be used with the TV's IR pass-through feature (➤ page 18).

To obtain IR blaster cable:

Visit www.ceaccessories.toshiba.com.

Optical audio cable



Optical audio cable is for connecting receivers with Dolby Digital or PCM (pulse-code modulation) optical audio input to the TV's **DIGITAL AUDIO OUT** terminal (➤ page 22).

Analog RGB (15-pin) computer cable

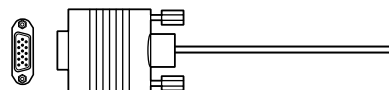

Analog RGB (15-pin) computer cable is for connecting a PC to the TV's **PC IN** terminal (➤ page 23).

Ethernet (RJ-45) cable

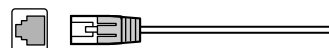

Ethernet (RJ-45) cable is used to connect the TV to your home network (➤ page 24 and Chapter 8).

About the connection illustrations

You can connect different types and brands of devices to your TV in several different configurations. The connection illustrations in this manual are representative of typical device connections only. The input/output terminals on your devices may differ from those illustrated herein. For details on connecting and using your specific devices, refer to each device's owner's manual.

Connecting a VCR and antenna or Cable TV (no Cable box)

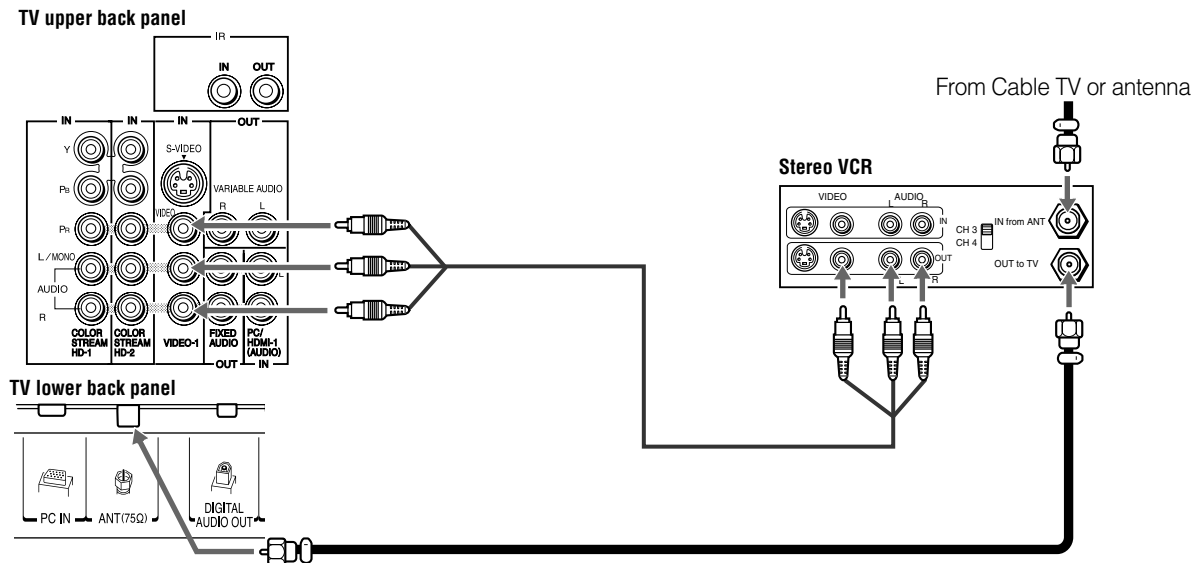

You will need:

- coaxial cables
- standard A/V cables
 - For better picture performance, if your VCR has S-video, use an S-video cable (plus the audio cables) instead of the standard video cable. Do not connect both types of video cable to **VIDEO 1** at the same time or the picture performance will be unacceptable.
 - If you have a mono VCR, connect **L/MONO** on the TV to your VCR's audio out terminal using the white audio cable only.

To view the antenna or Cable signal:

Select the **ANT** video input source on the TV.*

To view the VCR:

Turn ON the VCR. Select the **VIDEO 1** video input source on the TV.*

* To select the video input source, press **INPUT** on the remote control (see page 27). To program the TV remote control to operate other devices, see Chapter 3.

The unauthorized recording, use, distribution, or revision of television programs, videotapes, DVDs, and other materials is prohibited under the Copyright Laws of the United States and other countries, and may subject you to civil and criminal liability.

Connecting a VCR with S-video and a cable box

An S-video connection will provide better picture performance than a standard (composite) video cable.

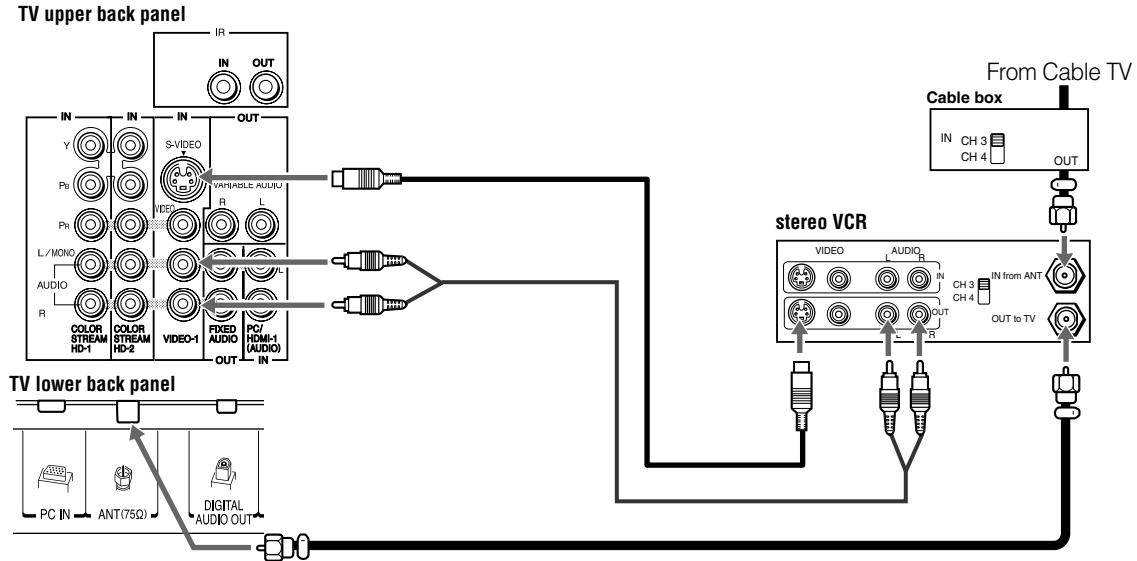

You will need:

- coaxial cables
- S-video cable
 - Do not connect both types of video cable to **VIDEO 1** at the same time or the picture performance will be unacceptable.
- standard audio cables
 - If you have a mono VCR, connect **L/MONO** on the TV to your VCR's audio out terminal using the white audio cable only.

Note: When you use a Cable box, you may not be able to use the remote control to program or access certain features on the TV.

To view basic and premium Cable channels:

Turn OFF the VCR. Select the **ANT** video input source on the TV.* Tune the TV to channel 3 or 4 (whichever channel the Cable box output is set to). Use the Cable box controls to change channels.

To view the VCR:

Turn ON the VCR. Select the **VIDEO 1** video input source on the TV.*

* To select the video input source, press **INPUT** on the remote control (page 27). To program the TV remote control to operate other devices, see Chapter 3.

The unauthorized recording, use, distribution, or revision of television programs, videotapes, DVDs, and other materials is prohibited under the Copyright Laws of the United States and other countries, and may subject you to civil and criminal liability.

Connecting a DVD player with ColorStream® (component video), a VCR, and a satellite receiver

Your TV has two sets of ColorStream® (component video) inputs.

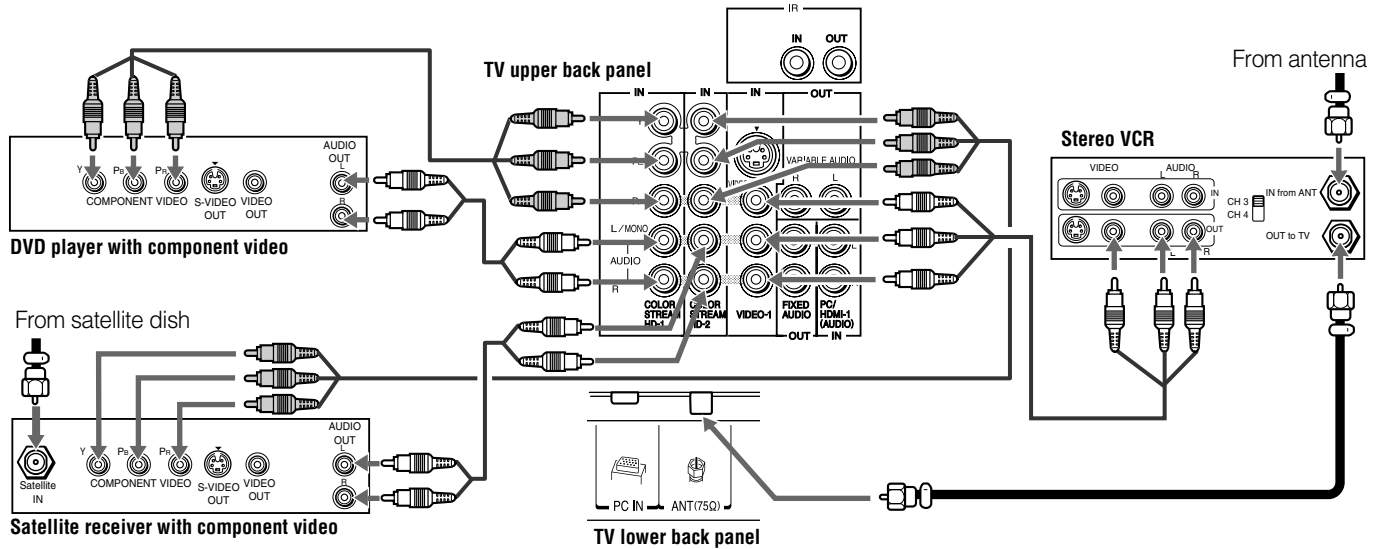

You will need:

- coaxial cables
- standard A/V cables
 - For better picture performance, if your VCR has S-video, use an S-video cable (plus the audio cables) instead of the standard video cable. Do not connect both types of video cable to **VIDEO 1** at the same time or the picture performance will be unacceptable.
 - If you have a mono VCR, connect **L/MONO** on the TV to your VCR's audio out terminal using the white audio cable only.
- standard audio cables
- component video cables
 - You can connect the component video cables (plus audio cables) from the DVD player or satellite receiver to either set of **ColorStream** terminals on the TV (**HD-1** or **HD-2**). The **ColorStream HD-1** and **HD-2** terminals can be used with Progressive (480p, 720p) and Interlaced (480i, 1080i) scan systems. A 1080i signal will provide the best picture performance (1080p is not supported).
 - If your DVD player or satellite receiver does not have component video, connect a standard A/V cable to **VIDEO 2** on the side panel. If your DVD player has HDMI video, see page 20.

To view antenna or Cable channels:

Select the **ANT** video input source on the TV.*

To view the DVD player:

Turn ON the DVD player. Select the **ColorStream HD-1** video input source on the TV.*

To view satellite programs using the component video connections:

Turn on the satellite receiver. Select the **ColorStream HD-2** video input source on the TV.*

To view the VCR or view and record antenna channels:

Turn ON the VCR. Tune the VCR to the channel you want to watch. Select the **VIDEO 1** video input source on the TV.*

To record a TV program while watching a DVD:

Turn ON the VCR. Tune the VCR to the channel to record. Select the **ColorStream HD-1** video input source on the TV* to view the DVD.

* To select the video input source, press **INPUT** on the remote control (page 27). To program the TV remote control to operate other devices, see Chapter 3.

The unauthorized recording, use, distribution, or revision of television programs, videotapes, DVDs, and other materials is prohibited under the Copyright Laws of the United States and other countries, and may subject you to civil and criminal liability.

Connecting a device to the IR OUT infrared terminal using the IR blaster cable for IR pass-through device control

You can use the TV's **IR OUT** terminal (infrared pass-through) to remotely operate (through the TV) many infrared remote-controlled devices (such as Toshiba infrared remote-controlled VCRs or DVD players) enclosed within an entertainment center or similar cabinet. Without the **IR OUT** connection, the device typically would need to be visible to operate it remotely.

You will need:

- dual-wand IR blaster cable (see page 14)
- other audio/video cables as required to connect the device(s) to the TV (see pages 15–20)

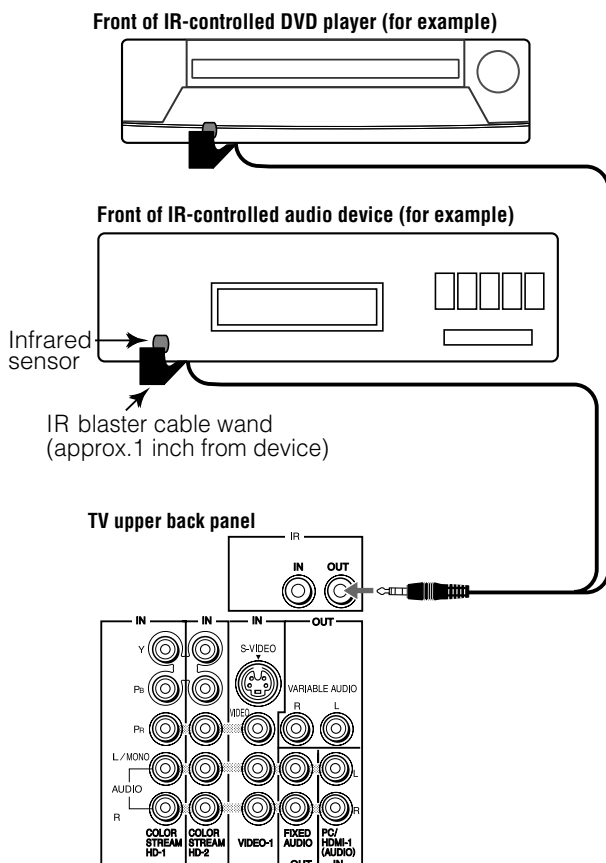

To connect the IR blaster cable:

- 1 Locate the infrared sensor on the front of your device. This sensor is marked on some devices.*
- 2 Align one of the IR blaster cable's wands about 1 inch away from the infrared sensor on the front of the device and attach it using double-sided mounting tape. If you have a second device, attach the second wand in a similar manner. (See illustration.)

Note: If you do not have a second device, coil the second wand with a rubber band and leave it behind the TV.

- 3 Plug the IR blaster cable's plug into the TV's **IR OUT** terminal.

To control the device(s):

Point either the device's remote control or the TV remote control (that you previously programmed to operate the device; see Chapter 3) toward the front of the TV and press the button for the desired function. The signal passes from the remote control through the TV to the device via the IR blaster cable.

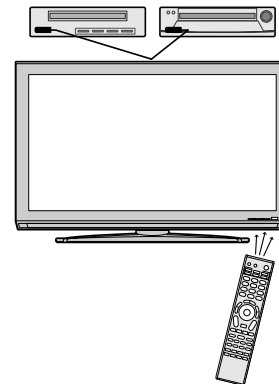

Note:

- If you use the device's remote control to operate the device, you also will need to use the TV's remote control to operate the TV.
- The IR pass-through feature does not support all IR-controlled devices; satisfactory performance may not be attainable with certain devices.

*If you cannot locate the device's infrared sensor:

- 1 Turn OFF the device.
- 2 Starting at the lower left corner of the device, place the end of the device's remote control (with the infrared emitter) so it touches the front of the device and press **POWER**. (Do not use the TV's remote control for this step.)
- 3 If the device turns on, the point at which the remote control touched the device is the location of the sensor.
- 4 If the device does not turn on, move the remote control slightly to the right and press **POWER** again.
- 5 Repeat step 4 until you locate the device's infrared sensor.

Connecting an IR receiver/repeater control system to the IR IN infrared terminal

For additional control options for your home theater system, you can connect an IR receiver/repeater control system (not included) to the TV's **IR IN** terminal.

You will need:

- IR cable

TV upper back panel

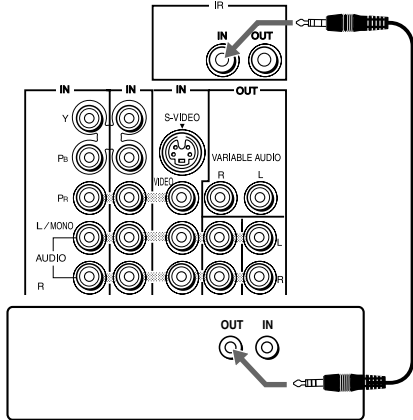

Back of IR receiver/repeater control system (not included)

To operate the TV with this connection, point the Toshiba TV remote control toward the front of the IR receiver/repeater control system.

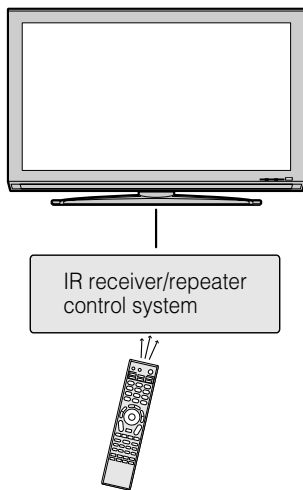

Connecting a camcorder

You will need:

- standard A/V cables
 - For better picture performance, if your camcorder has S-video, connect an S-video cable (plus the audio cables) to **VIDEO 1** on the TV back instead of the **VIDEO 2** on the TV right side panel.

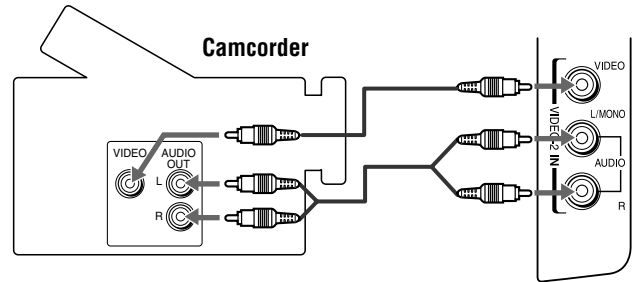

VIDEO 2 inputs on TV right side panel

To view the camcorder video:

Select the **VIDEO 2** video input source on the TV.*

* To select the video input source, press **INPUT** on the remote control (page 27). To program the TV remote control to operate other devices, see Chapter 3.

Connecting an HDMI™ or DVI device to the HDMI input

The HDMI input on your TV receives digital audio and uncompressed digital video from an HDMI source device, or uncompressed digital video from a DVI (Digital Visual Interface) source device.

This input is designed to accept HDCP (High-Bandwidth Digital-Content Protection) program material in digital form from EIA/CEA-861-D-compliant^[1] consumer electronic devices (such as a set-top box or DVD player with HDMI or DVI output).

The HDMI input can accept and display VGA, 480i (60Hz), 480p (60Hz), 720p (60Hz), 1080i (60Hz), and 1080p (24Hz/60Hz) signal formats. For detailed signal specifications, see page 109.

Note:

- Some of legacy HDMI sources may not work properly with your latest HDMI TV, due to new standard adoption. Please try to set Off the following three options (Lip-Sync Latency, Deep Color, xvYCC). Your legacy HDMI source should operate properly with your TV. See page 75.
- Supported Audio format : Linear PCM, sampling rate 32/44.1/48kHz

To connect an HDMI device, you will need:

- one HDMI cable (type A connector) per HDMI device
 - For proper operation, it is recommended that you use an HDMI cable with the HDMI Logo (HDMI).
 - If your HDMI connection is capable of 1080p and/or your TV is capable of refresh rates greater than 60Hz or supports Deep Color™, you will need a Category 2 cable. Conventional HDMI/DVI cable may not work properly with this mode.
 - HDMI cable transfers both video and audio. Separate analog audio cables are not required (see illustration).
 - See “Setting the HDMI™ audio mode” (page 48).

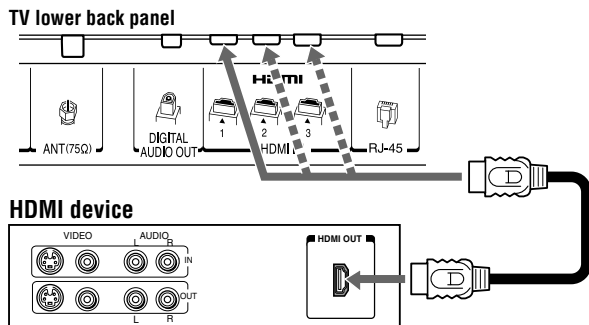

To view the HDMI device video:

Select the HDMI 1, HDMI 2, or HDMI 3 video input source on the TV.*

* To select the video input source, press **INPUT** on the remote control (page 27). To program the TV remote control to operate other devices, see Chapter 3.

To connect a DVI device, you will need:

- one HDMI-to-DVI adapter cable (HDMI type A connector) per DVI device
 - For proper operation, the length of an HDMI-to-DVI adapter cable should not exceed 9.8 ft (3m). The recommended length is 6.6 ft (2m).
- one pair of standard analog audio cables per DVI device
 - An HDMI-to-DVI adapter cable transfers video only. Separate analog audio cables are required (see illustration).
 - See “Setting the HDMI™ audio mode” (page 48).

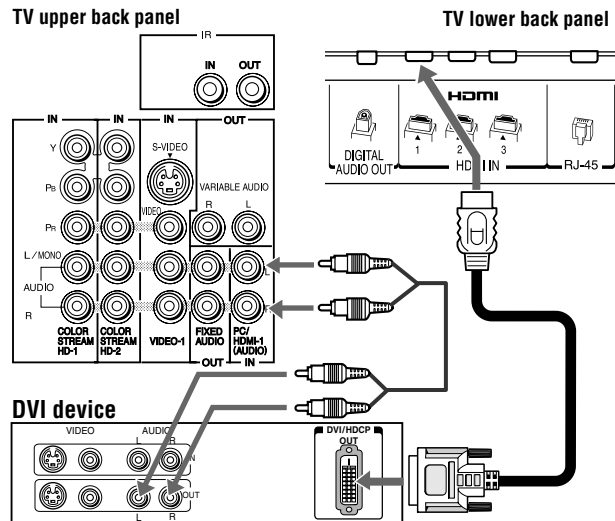

Note: To ensure that the HDMI or DVI device is reset properly, it is recommended that you follow these procedures:

- When turning on your electronic components, **turn on the TV first**, and then the HDMI or DVI device.
- When turning off your electronic components, **turn off the HDMI or DVI device first**, and then the TV.

[1] EIA/CEA-861-D compliance covers the transmission of uncompressed digital video with high-bandwidth digital content protection, which is being standardized for reception of high-definition video signals. Because this is an evolving technology, it is possible that some devices may not operate properly with the TV.

HDMI, the HDMI logo and High-Definition Multimedia Interface are trademarks or registered trademarks of HDMI Licensing LLC.

CE-Link connection

You can control the basic functions of connected audio/video devices using the TV's remote control if you connect a CE-Link compatible audio receiver or playback device. For an explanation of setup and operations, see pages 73–74.

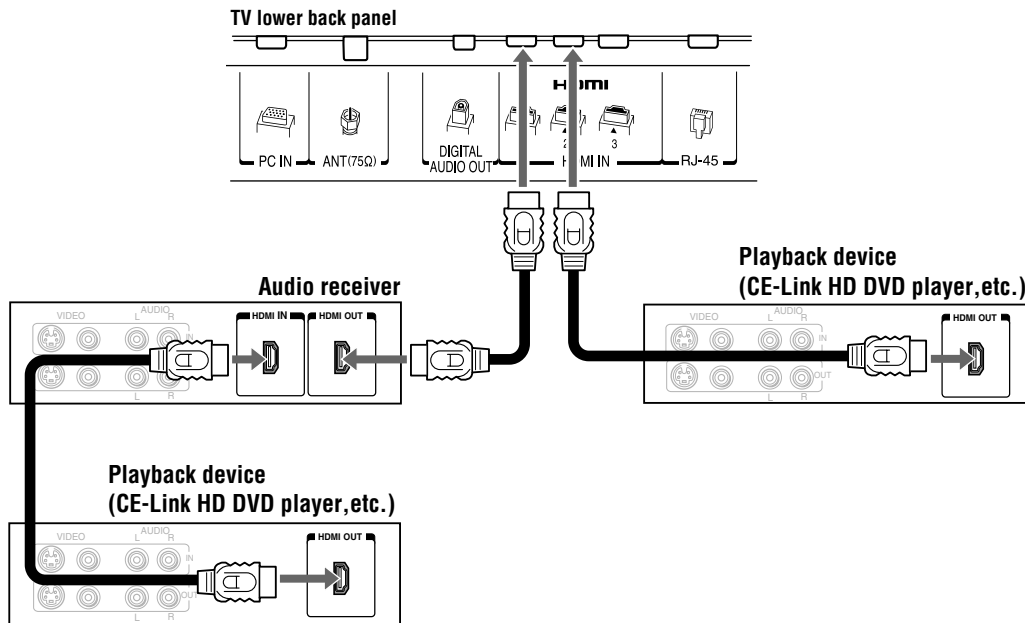

To connect an Audio Receiver and Playback Device, you will need:

- three HDMI cables (☞ page 20)

Note:

- If several devices are connected, the CE-Link feature may not operate properly.
- For proper operation, it is recommended that you use HDMI cables with the HDMI Logo (HDMI).

Before controlling the device(s):

- After completing the above connections, set the **CE-Link Setup** menu as you desire (☞ page 75).
- The connected devices must also be set. For details, see the operation manual for each device.
- The CE-Link feature uses CEC technology as regulated by the HDMI standard.
- This feature is limited to models incorporating Toshiba's CE-Link. However, Toshiba is not liable for those operations. Refer to individual instruction manuals for compatibility information.

Connecting a digital audio system

The TV's **DIGITAL AUDIO OUT** terminal outputs a Dolby®* Digital or 2-channel down-mixed PCM (pulse-code modulation) signal for use with an external Dolby® Digital decoder or other external audio system with optical audio input.

You will need:

- optical audio cable (Use an optical audio cable that has the larger "TosLink" connector and not the smaller "mini-optical" connector.)

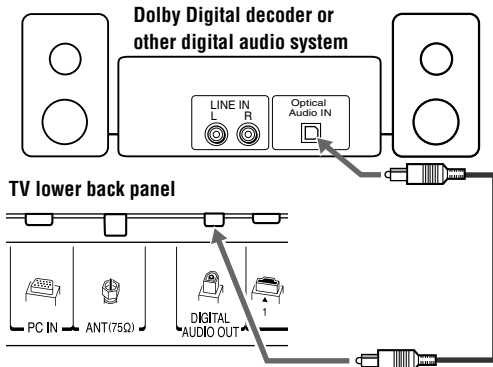

To control the audio:

- 1 Turn on the TV and the digital audio device.
- 2 Press **MENU** on the TV's remote control and open the **Audio** menu.
- 3 Highlight **Audio Setup** and press **ENTER**.

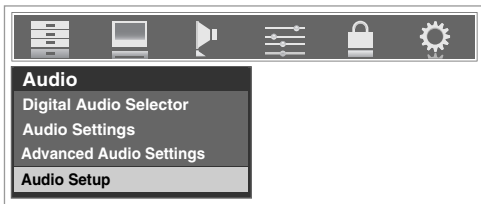

- 4 In the **Optical Output Format** field, select either **Dolby Digital** or **PCM**, depending on your device (👉 "Selecting the optical audio output format" on page 66).

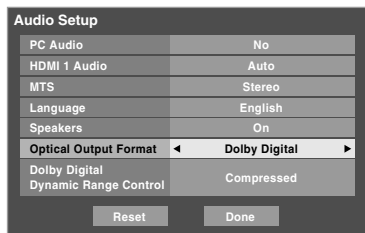

Note:

- Some audio systems may not be compatible with Dolby Digital bitstream signals. Older audio systems that are not compatible with standard optical out signals may not work properly, creating a high noise level that may damage speakers or headphones. **THIS DAMAGE IS NOT COVERED BY YOUR WARRANTY.**
- The **DIGITAL AUDIO OUT** terminal may not output some digital audio sources because of copy restrictions.

* Manufactured under license from Dolby Laboratories. Dolby, Pro Logic, and the double-D symbol are registered trademarks of Dolby Laboratories.

Connecting an audio system

This connection allows you to use external speakers with an external analog audio amplifier to adjust the sound level.

You will need:

- standard audio cables

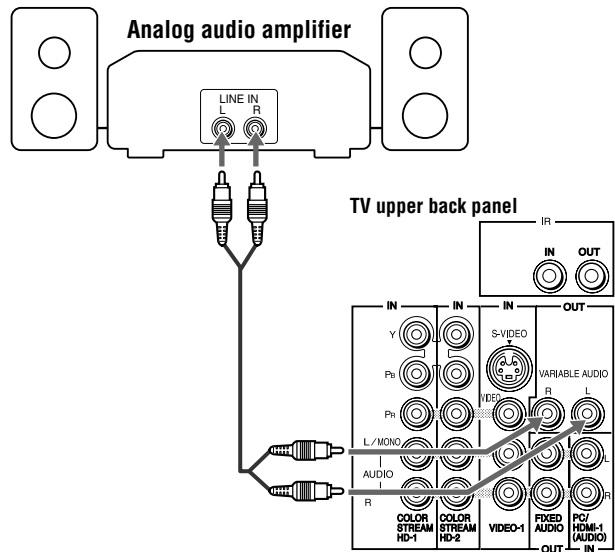

To control the audio:

- 1 Turn on the TV and the stereo amplifier.
- 2 Turn off the TV's built-in speakers (👉 page 66).

Note: To hear sound when using an external audio amplifier, the volume of both the TV and the amplifier must be set to a reasonable listening level.

Connecting a personal computer (PC)

With either the PC IN or HDMI connection, you can watch your computer's display on the TV and hear the sound from the TV's speakers.

To connect a PC to the PC IN terminal on the TV:

When connecting a PC to the PC IN terminal on the TV, use an analog RGB (15-pin) computer cable and a PC audio cable.

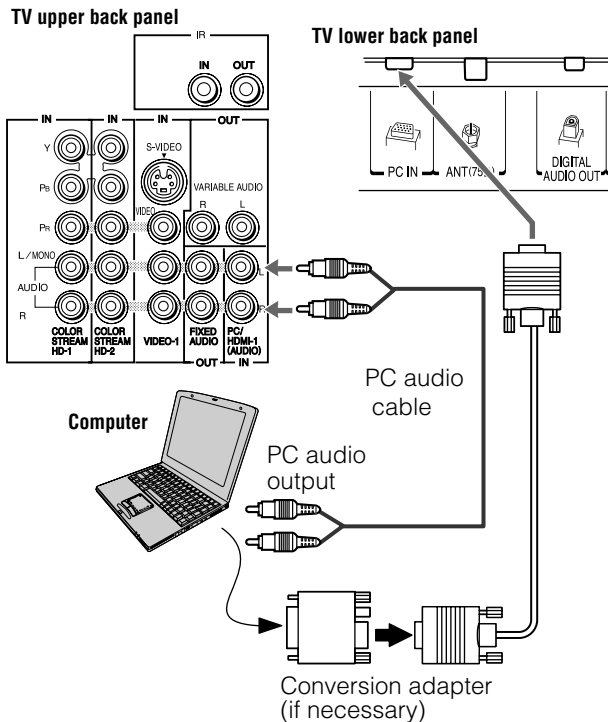

- To use a PC, set the monitor output resolution on the PC before connecting it to the TV. The following signals can be displayed:

Format	Resolution	V. Frequency
VGA	640 × 480	60Hz
SVGA	800 × 600	60Hz
XGA	1024 × 768	60Hz

Other formats or non-standard signals will not be displayed correctly.

- To display the optimum picture, use the PC setting feature (☞ “Using the PC settings feature” on page 72).

Note:

- The PC audio input terminals on the TV are shared with the HDMI-1 analog audio input terminals (☞ page 72).
- Some PC models cannot be connected to this TV.
- An adapter is not needed for computers with a compatible mini D-sub 15-pin terminal.

- Depending on the DVD's title and the specifications of the PC on which you are playing the DVD-Video, some scenes may be skipped or you may not be able to pause during multi-angle scenes.
- Signal names for mini D-sub 15-pin connector

Pin No.	Signal name	Pin No.	Signal name	Pin No.	Signal name
1	R	6	Ground	11	NC
2	G	7	Ground	12	NC
3	B	8	Ground	13	H-sync
4	NC *	9	NC	14	V-sync
5	NC	10	Ground	15	NC

*NC=Not connected

To connect a PC to the HDMI terminal on the TV:

When connecting a PC to the HDMI terminal on the TV, use an HDMI-to DVI adapter cable and analog audio cables. If connecting a PC with an HDMI terminal, use an HDMI cable (type A connector). Separate analog cables are not necessary (☞ page 20).

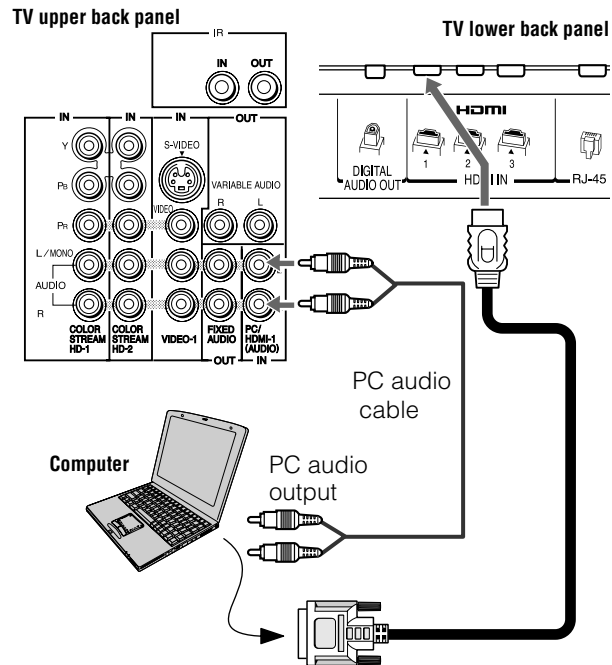

The HDMI input can accept and display VGA, 480i (60Hz), 480p (60Hz), 720p (60Hz), 1080i (60Hz), and 1080p (24Hz/60Hz) signal formats. For detailed signal specifications, see page 109.

Note:

- The edges of the images may be hidden.
- If receiving a 720p, 1080i, or 1080p signal program, Native mode scales the video to display the entire picture within the borders of the screen (i.e. no overscanning).

Connecting a home network

The Toshiba Home Interactive Network Connection (THINC™) feature allows you to network the TV with your home PC (personal computer), which will allow access to the TV's file sharing and personal e-mail features.

File sharing

You can access JPEG and MP3 files that are stored on your networked home PC and view/play them on the TV.

- Connect your TV to your home network according to either Example #1 at right or Example #2 on the next page.
- Does NOT require Internet/e-mail service.

Personal E-mail

You can receive a personal e-mail via your TV. (This connection also allows access to file sharing, as described above.)

- Connect your TV to your home network according to Example #3 on the next page.
- Requires the following:
 - Home Internet service.
 - A personal e-mail address.
- Contact your ISP (Internet Service Provider) to obtain and set up Internet/e-mail service.
- **See Chapter 8 for details on configuring and using personal e-mails, file sharing, the JPEG Picture Viewer, and the MP3 Audio Player.**

Note:

- The TV's home network feature is compatible with Microsoft® Windows® 2000, and the Home or Professional version of Microsoft® Windows® XP Service Pack 2 or higher. See Chapter 8 for details.
- The TV's home network connection allows access to file sharing only. **You will NOT be able to use the TV to access the Internet.**
- If you use an Ethernet crossover cable to connect your PC directly to the TV, you will not be able to use the automatic setup and must manually set up the network address.
- If you use a hub or switch to connect the TV to your home network, you will not be able to use the automatic setup and must manually set up the network address.
- If you use a router with built-in DHCP functionality, use the automatic setup. Manual setup may not work.

Microsoft and Windows are either registered trademarks or trademarks of Microsoft Corporation in the United States and/or other countries.

Example #1: Connecting the TV to a home network without an Internet connection

You will need:

- standard Ethernet (RJ-45) cables
- hub or switch

TV lower back panel

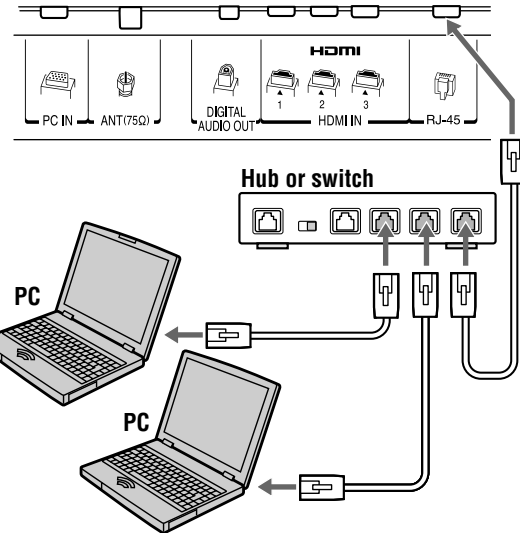

Example #2: Connecting the TV directly to a PC without an Internet connection

You will need:

- **Ethernet crossover** cable (i.e., a PC-to-PC direct file transfer cable)

Note: Do not use standard Ethernet cable with this connection.

TV lower back panel

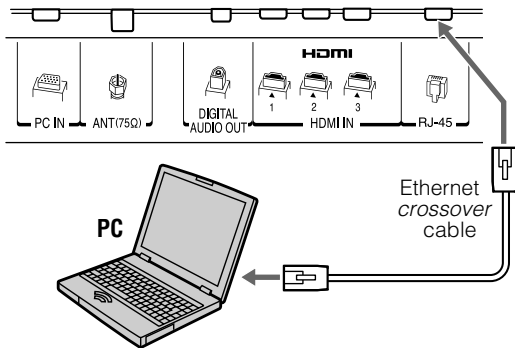

Example #3: Connecting the TV to a home network with an Internet connection

You will need:

- coaxial or telephone cable (depending on your modem)
- **standard Ethernet (RJ-45)** cables
- router/switch^[1]
- modem (DSL or cable)^[2]

TV lower back panel

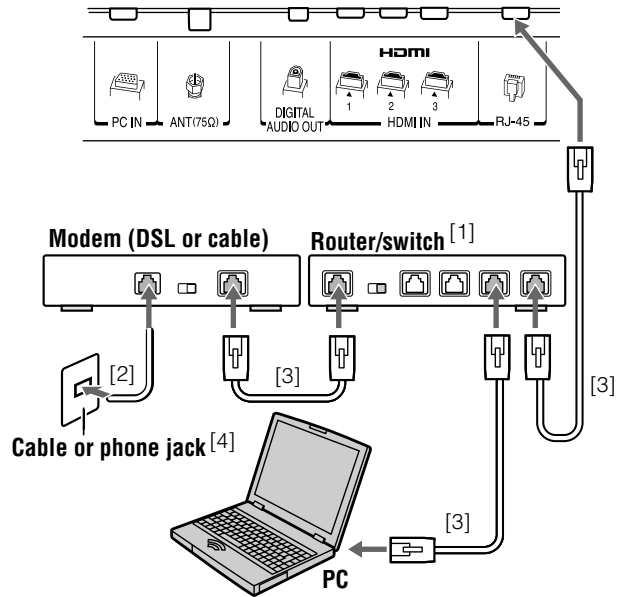

[1] Your router/switch may be part of your DSL or cable modem. Your switch may be separate from your router. For assistance, contact your ISP or an IT professional.
 [2] Coaxial or telephone cable (depending on your modem type)
 [3] Standard Ethernet (RJ-45) cable
 [4] Do NOT connect a phone jack directly to the TV's RJ-45 (Ethernet) port.

Chapter 3: Using the remote control

Installing the remote control batteries

To install the remote control batteries:

- 1 Slide the battery cover off the back of the remote control.

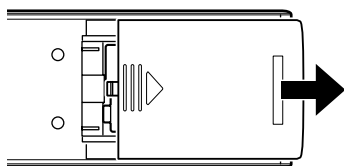

- 2 Install two “AA” size alkaline batteries. Match the + and – symbols on the batteries to the symbols on the battery compartment.

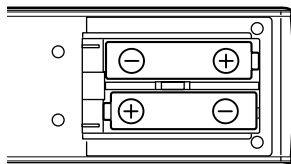

- 3 Slide the battery cover on to the remote control until the lock snaps.

Caution: Never throw batteries into a fire.

Note:

- Be sure to use AA size alkaline batteries.
- Dispose of batteries in a designated disposal area.
- Batteries should always be disposed of with the environment in mind. Always dispose of batteries in accordance with applicable laws and regulations.
- If the remote control does not operate correctly, or if the operating range becomes reduced, replace batteries with new ones.
- When necessary to replace batteries in the remote control, always replace both batteries with new ones. Never mix battery types or use new and used batteries in combination.
- Always remove the batteries from the remote control if they are dead or if the remote control is not to be used for an extended period of time. This will prevent battery acid from leaking into the battery compartment.

Remote control effective range

For optimum performance, aim the remote control directly at the TV remote sensor. Make sure there are no obstructions between the remote control and the TV.

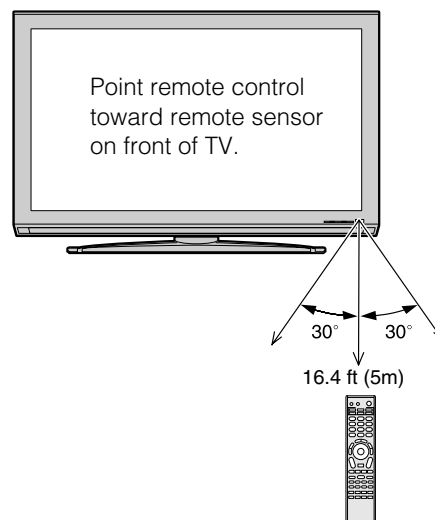

Learning about the remote control

The buttons used for operating the TV only are described here. For the CE-Link remote control functions, see the section “Using CE-Link” (page 73). For a complete list of the remote control’s functions, see the remote control functional key chart (pages 29–30).

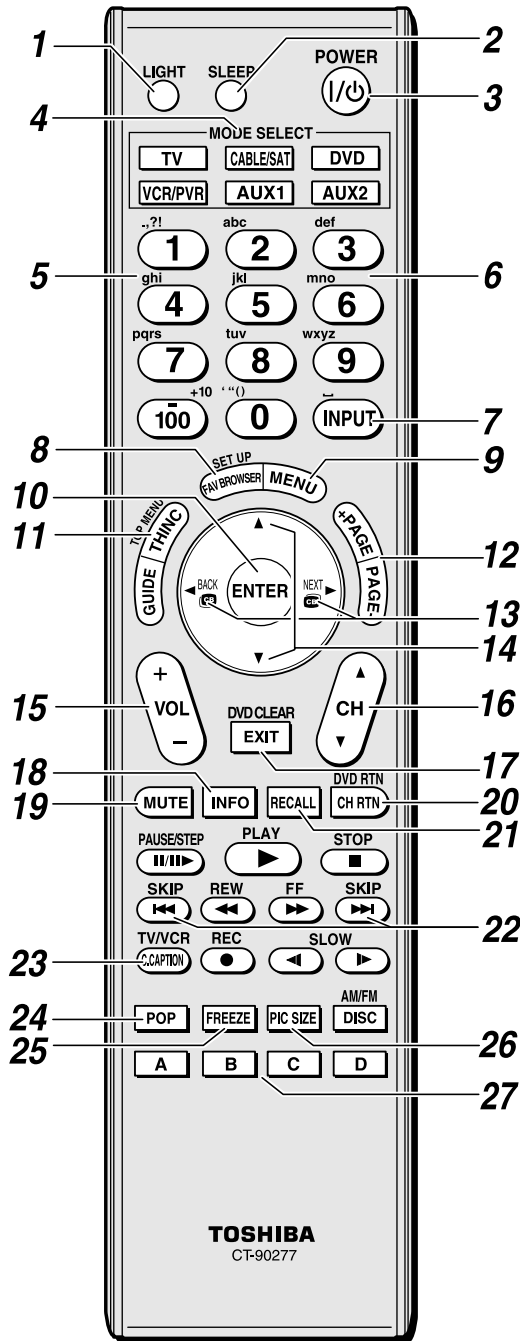

Note: The error message “Not Available” may appear if you press a key for a function that is not available.

- 1 **LIGHT** illuminates the keypad for five seconds. The **MODE SELECT** key that is currently selected blinks three times.
- 2 **SLEEP** accesses the sleep timer (page 73).
- 3 **POWER** turns the TV on and off. When the TV is on, the green LED indicator on the TV front will be illuminated.
- 4 **MODE SELECT** sets the six remote control device modes: **TV**, **CABLE/SAT**, **DVD**, **VCR/PVR**, **AUX 1**, and **AUX 2**. Press **TV** until the keypad blinks 3 times to control the TV. The selected **MODE** key blinks each time any key is pressed. (page 31). When the Auto Input feature is set, these keys can also be used to change inputs on the TV (page 46).
- 5 **Software Keyboard (0-9, -/100, INPUT)** used for entering alpha-numeric data primarily in conjunction with the **THINC** features (page 94).
- 6 **Channel Numbers (0-9, -/100)** directly tune channels. The **100** button is used to tune digital channels (page 55) or to edit the Favorites List (page 53).
- 7 **INPUT** selects the video input source (page 51).
- 8 **FAV BROWSER** accesses the Favorites List in the Channel Browser™ (page 53).
- 9 **MENU** accesses the main TV menu system (pages 40 and 41).
- 10 **ENTER** activates highlighted items in the main menu system.
- 11 **THINC** accesses the THINC menu (page 41).
- 12 **PAGE + / -** are used for paging up and down in the Personal E-mail feature.
- 13 **BACK** ◀ / **NEXT** ▶ While watching TV, these buttons open the Channel Browser™ and tune to the previous/next channel in the channel history (page 54). (Also see “Arrow buttons.”)
- 14 **Arrow buttons (▲▼◀▶)** When a menu is on-screen, these buttons select or adjust programming menus. (Also see **BACK** ◀ / **NEXT** ▶.)
- 15 **VOL + -** adjusts the volume level.
- 16 **CH ▲▼** cycles through programmed channels when no menu is on-screen (page 44).
- 17 **EXIT** closes on-screen menus.
- 18 **INFO** displays TV status information as well as program details, when available (page 76).
- 19 **MUTE** reduces or turns off the sound (page 64).
- 20 **CH RTN** returns to the last viewed channel or source (page 55), or stops the Picture Viewer slide show (page 97). Also can be used to switch between the Song Select view and File Select view in the Audio Player (page 98).

(continued)

- 21 RECALL** displays TV status information (🔍 page 76).
- 22 SKIP** ⏮ and **SKIP** ⏭ can be used for jumping to the beginning and end of a line when used with the software keyboard (🔍 page 94).
- 23 C.CAPTION (TV/VCR)** opens the closed caption/audio selector screen. (The audio selector is not available for analog channels.) (🔍 page 63.) By using this button, it is also possible to select TV mode and view one program while another is being recorded.
- 24 POP** opens the POP double-window (🔍 page 59).
- 25 FREEZE** freezes the picture. Press again to restore to moving picture (🔍 page 59).
- 26 PIC SIZE** cycles through the picture sizes: **Natural**, **TheaterWide 1/2/3**, **Full**, **4:3 HD**, and **Native** (🔍 page 56).
- 27** **A** and **D** are used with the ColorMaster Pro (🔍 page 81) and THINC features (🔍 page 102).

Remote Control functional key chart

REMOTE CONTROL KEY	Toshiba TV (TV)	CABLE	SAT (satellite)	VCR	•DVD/VCR combo • DVD/DVD-R	Receiver/AMP	CD (AUDIO)	PVR
MODE SELECT	Remote control device mode selection							
LIGHT	Lights the remote control keys.*1							
SLEEP	Sleep timer	← TV	← TV	← TV	← TV	← TV	← TV	← TV
POWER	Power	Power	Power	Power	Power	Power	Power	Power
1 (, ? !)	Digit 1*2	Digit 1	Digit 1	Digit 1	Digit 1	AV input 1	Digit 1	Digit 1
2 (a b c)	Digit 2*2	Digit 2	Digit 2	Digit 2	Digit 2	AV input 2	Digit 2	Digit 2
3 (d e f)	Digit 3*2	Digit 3	Digit 3	Digit 3	Digit 3	AV input 3	Digit 3	Digit 3
4 (g h i)	Digit 4*2	Digit 4	Digit 4	Digit 4	Digit 4	AV input 4	Digit 4	Digit 4
5 (j k l)	Digit 5*2	Digit 5	Digit 5	Digit 5	Digit 5	CD	Digit 5	Digit 5
6 (m n o)	Digit 6*2	Digit 6	Digit 6	Digit 6	Digit 6	Tuner	Digit 6	Digit 6
7 (p q r)	Digit 7*2	Digit 7	Digit 7	Digit 7	Digit 7	Phono	Digit 7	Digit 7
8 (t u v)	Digit 8*2	Digit 8	Digit 8	Digit 8	Digit 8	Cassette	Digit 8	Digit 8
9 (w x y z)	Digit 9*2	Digit 9	Digit 9	Digit 9	Digit 9	Aux	Digit 9	Digit 9
0 (‘ “ ())	Digit 0*2	Digit 0	Digit 0	Digit 0	Digit 0	---	Digit 0, 10	Digit 0
100-/÷+10	- (digital separator)*2	---	-/÷, +10, +100	+100	-/÷, +10, +100	---	---	---
INPUT (-)	TV/Video select*2	← TV	← TV	← TV	← TV	Input	← TV	← TV
PIC SIZE	Selects the image shape	← TV	← TV	← TV	← TV	← TV	← TV	← TV
MENU	Menu/Guide Menu	Menu	Menu	---	Menu	Menu	Menu	Menu
FAV BROWSER/SET UP	FAV BROWSER	---	---	---	Setup	---	---	---
THINC/TOP MENU	THINC	← TV	← TV	← TV	Top menu	← TV	← TV	← TV
GUIDE	Guide*	Guide	Guide	---	Guide	---	---	Guide
INFO	Guide Info	Info	Info	---	Display	---	---	Info
ENTER	Enter	Select	Select	---	Select	---	---	Select
▲	Menu select up	Cursor up	Cursor up	---	Cursor up	---	---	Cursor up
▼	Menu select down	Cursor down	Cursor down	---	Cursor down	---	---	Cursor down
◀ BACK NEXT ▶	Menu select left/right BACK Back NEXT Next	Cursor left/right	Cursor left/right	---	Cursor left/right	---	---	Cursor left/right
EXIT/DVD CLEAR	Exit	Exit	Exit	---	DVD clear	---	---	Exit
PAGE +/-	Page up/down	Page up/down	Page up/down	---	Page up/down	---	---	---
VOL +/-	Volume up/down*3	Volume up/down*3	Volume up/down*3	Volume up/down*3	Volume up/down*3	Volume up/down	Volume up/down	Volume up/down*3

(continued)

Chapter 3: Using the remote control

REMOTE CONTROL KEY	Toshiba TV (TV)	CABLE	SAT (satellite)	VCR	•DVD/VCR combo • DVD/DVD-R	Receiver/AMP	CD (AUDIO)	PVR
CH RTN/ DVD RTN	Previous channel	Previous channel	Previous channel	---	DVD RTN	---	---	---
RECALL	On-screen display	← TV	← TV	← TV	← TV	← TV	← TV	← TV
MUTE	Sound mute	Sound mute* ³	Sound mute* ³	Sound mute* ³	Sound mute* ³	Sound mute	Sound mute	Sound mute* ³
SLOW	Slow FWD* Slow REW*	---	---	Slow FWD Slow REW	Slow FWD Slow REW	---	---	Slow FWD Slow REW
SKIP ►► SKIP ◄◄	DAY+* ² DAY-* ²	---	---	---	Skip FWD Skip REW	---	Skip FWD Skip REW	---
REW	Rewind*	Rewind	Rewind	Rewind	Rewind	---	Rewind	Rewind
PAUSE/STEP	Pause*	Pause	Pause	Pause	Pause	---	Pause	Pause
PLAY	Play*	Play	Play	Play	Play	---	Play	Play
FF	Fast FWD*	Fast FWD	Fast FWD	Fast FWD	Fast FWD	---	Fast FWD	Fast FWD
C.CAPTION TV/VCR	C.Caption	---	TV/SAT	TV/VCR	---* ⁴	---	---	---
DISC/AM/FM	---	---	---	---	---* ⁵	AM/FM	Disc SKIP Disc select	Instant replay
STOP	Stop*	Stop	Stop	Stop	Stop	---	Stop	Stop
REC	REC Menu* (Single click)	Record (Double click)	Record (Double click)	Record (Double click)	Record (Double click)* ⁶	---	---	Record (Double click)
CH ▲ ▼	Channel up/ down	Channel up/ down	Channel up/ down	Channel up/ down	Channel up/ down	Channel up/ down	---	Channel up/ down
POP	Split	← TV	← TV	← TV	← TV	← TV	← TV	← TV
FREEZE	Freeze	← TV	← TV	← TV	← TV	← TV	← TV	← TV
A and D	A and D	---	---	---	---	---	---	---

Note:

- "—" = key does not send a signal in that remote control mode.
- "← TV" = key will affect the TV, even though the remote control is in another mode.
- * Not available for your TV. However, you can use the certain remote buttons to control the CE-Link devices (see page 73).

¹ Does not send IR signal.

² In Software Keyboard mode, repeatedly pressing the key toggles through all available characters for that key. See "Using the software keyboard" on page 94.

³ Volume will affect the TV by default. When the volume is unlocked, all the devices will have their own volume if their ID has volume data. The **AUDIO** modes (receiver, CD) will have their own volume if volume lock is set on **TV, CABLE/SAT, VCR/PVR**, or **DVD** mode. See "Using the volume lock feature" (see page 32).

⁴ DVD/VCR combo : TV/VCR

⁵ DVD/VCR combo : DVD/VCR

⁶ DVD/DVD-R : RECORD is only for DVD-R, no function is picked for DVD.

Using the remote control to operate your other devices

Your TV remote control has one dedicated TV mode and three programmable multi-brand modes: **CABLE/SAT**, **DVD**, **VCR/PVR**, **AUX 1**, and **AUX 2**. The default device modes and programmable device modes are listed below.

Note: The TV remote control is preprogrammed to operate most Toshiba devices. To operate a non-Toshiba device or a Toshiba device that the remote control is not preprogrammed to operate, you will need to program the remote control. See “Programming the remote control to operate your other devices” (at right).

MODE SELECT	Default device mode control (before programming)
TV	Toshiba TV
CABLE/SAT	Toshiba Satellite receiver
DVD	Orion DVD
VCR/PVR	Toshiba VCR
AUX 1	Yamaha Audio receiver
AUX 2	Onkyo Audio receiver

MODE SELECT	Device mode control after programming
TV	Toshiba TV
CABLE/SAT	
DVD	
VCR/PVR	Multi-brand video/audio devices
AUX 1	
AUX 2	

Note: Although your new TV’s remote control includes codes for many devices, it may not include codes for some or all of the features on certain devices you wish to control. If you are unable to program the TV’s remote control to operate your device or some of the features on that device, use the device’s remote control or the controls on the device.

Programming the remote control to operate your other devices

Device code setup

- Find the code for your device brand in the remote control device code table on pages 33–39.
If more than one code is listed, try each one separately until you find one that works.
- Press the applicable MODE SELECT button (**CABLE/SAT**, **DVD**, **VCR/PVR**, **AUX 1**, or **AUX 2**), until the MODE SELECT button blinks 3 times.
- While holding down **RECALL**, press the five-digit device code for your device.
 - If a valid code is entered, the MODE SELECT button will blink twice.
 - If an invalid code is entered, the MODE SELECT button will blink one long blink.
- Point the remote control at the device and press **POWER** to test the code.
 - If the device responds to the remote control, you have entered the correct code.
 - If the device does not respond to the remote control, repeat steps 3 and 4 using another code.

Note: After programming the remote control, make sure all necessary keys on the TV remote control (in addition to **POWER**) operate your device. If some keys are not operational, repeat the device code setup using another code (if other codes are listed for your device). If, after trying all listed codes, the necessary keys do not operate your device, use the device’s original remote control.

- To control the TV, press the “TV” MODE SELECT button.

Note:

- Although the TV remote control includes codes for many devices, it may not include codes for some or all of the features on certain devices you want to control. If you are unable to program the TV remote control to operate your device or some of the features on that device, use the device’s original remote control (or the control buttons on the device).
- Every time you change the batteries you will need to reprogram the remote control.
- Some newer VCRs respond to either of two codes. These VCRs have a switch labeled “VCR1/VCR2.” If your VCR has this kind of switch and does not respond to the codes for your VCR brand, set the switch to the other position (“VCR1” or “VCR2”) and reprogram the remote control.

Searching and sampling the code of a device (8500)

If you do not know the device code for a particular device, you can cycle the remote control through the available codes for that device mode and sample the functions to find the code that operates the target device. The keys available to be sampled, provided they are applicable to that mode, are **POWER**, 1, **VOL**, **CH**, and **PLAY**. Invalid keys will be ignored while in program mode.

To cycle through each available device code and sample its functions:

- 1 Press the appropriate MODE SELECT button on the remote control.
- 2 While holding down **RECALL**, press 8, 5, 0, 0. The remote control will enter program mode.
- 3 Point the remote control at the target device and press **POWER** (or other function buttons that are available to be sampled).
- 4 If the device responds to the remote control:
Press **RECALL** to store the device code. The MODE SELECT button will blink two times and the remote control will exit the program mode.

If the device does not respond to the remote control:

Press **▲**, and then press **POWER**. Repeat this step until the device responds to the remote control, and then press **RECALL**.

Note: When a search cycle is completed, the MODE SELECT button will blink three times. The remote control will begin to cycle through the available codes again. If no key is pressed within 10 seconds during programming, the remote control will exit the program mode and return to the previous code.

Using the volume lock feature (8000)

By default (factory setting), the remote control's volume keys (**VOL** and **MUTE**) are locked to the "TV" device mode.

The remote control will operate the TV's volume, even when "TV" is not the current device mode. (This includes all remote control device modes except AUX 1 and AUX 2).

If you unlock the remote control's volume keys, each device mode will have its own volume (if the device ID has volume data). The remote control will operate the volume of the device associated with the current device mode. (This includes all remote control device modes.)

If you lock the remote control's volume keys to a specific device mode, the remote control will operate the volume of the device associated with the locked mode, even when the locked mode is not the current device mode. (This includes all device modes except AUX 1 and AUX 2).

When the remote control is in AUX 1 (or AUX 2) mode, the remote control will operate the volume of the device associated with the AUX 1 (or AUX 2) mode, even when the volume is locked to another mode.

See "Using the remote control to operate your other devices" on page 31.

To lock the remote control's volume keys to a specific mode (CABLE/SAT in this example):

- 1 Press CABLE/SAT.
- 2 While holding down the **RECALL** button, press 8, 0, 0, 0.
- 3 Press **VOL**. The CABLE/SAT MODE SELECT button will blink two times (locked).

The remote control's volume keys will now operate the volume of the device associated with the CABLE/SAT mode, even when CABLE/SAT is not the current device mode (for all device modes except AUX 1 and AUX 2).

To unlock the remote control's volume keys:

- 1 While holding down **RECALL**, press 8, 0, 0, 0.
- 2 Press **VOL**. The CABLE/SAT MODE SELECT button will blink four times (unlocked).

Operational feature reset (8900)

This feature clears all programmed remote control features not related to "Device code setup" and resets the volume lock to the "TV" device mode.

To reset the remote control:

While holding down **RECALL**, press 8, 9, 0, 0. The MODE SELECT button will respond with four blinks.

Multi-brand remote control device codes

TVs

Brand	Code
Toshiba	01524

Cable boxes

Brand	Code
A-Mark	10008, 10144
ABC	10237, 10003, 10008, 10014, 10017
Accuphase	10003, 10014, 10017
Acorn	10237
Action	10237
Active	10237
Americast	10899
Amino	11822
Archer	10237
BCC	10276
Bell & Howell	10014
Bell South	10899
British Telecom	10003
Century	10008
Citation	10017
Clearmaster	10883
ClearMax	10883
Cool Box	10883
Coolmax	10883
Digeo	11187
Digi	10637
Director	10476
Dumont	10637
Emerson	10014
Fosgate	10276
GE	10144
Motorola/GI/Jerrold	10014, 10276, 10476, 10810
GI/Jerrold	10003, 10012
Motorola	11106, 11187, 11376
Gibraltar	10003
GMI	10883
GoldStar	10144
Hamlin	10009, 10273
Hitachi	10003, 10008, 10009
Insight	10476, 10810
Jebsee	10014
Memorex	10000
Mitsubishi	10003
Multitech	10883
Myrio	11822
Nova Vision	10008
Novaplex	10008, 10017
NSC	10012, 10637
Oak	10017
Pace	11877, 10877, 10237, 10008

Panasonic	10000, 10008, 10144, 10107
Panther	10637
Paragon	10000, 10008, 10525
Penney	10000, 10637
Philips	11305, 10317
Pioneer	11877, 10877, 10144, 10533
Prism	10012
Pulsar	10000
Quasar	10000
RadioShack	10883
RCA	11256
Regal	10276, 10279, 10273
Runco	10000
Samsung	10003, 10144
Scientific Atlanta	11877, 10877, 10477, 10237, 10003, 10000, 10008, 10012, 10017
Sony	11006
Sprucer	10144
Starcom	10003, 10014
Stargate	10014
Storm	10637
Supercable	10276
Supermax	10883
Thomson	11256
Tocom	10012
Torx	10003
Toshiba	10000
Tristar	10883
United Cable	10276, 10003, 10014
US Electronics	10276, 10003, 10008, 10017
V2	10883
Videoway	10000
Viewmaster	10883
Vision	10883
Vortex View	10883
Zenith	10000, 10525, 10899, 10017

Satellite receivers

Brand	Code
AlphaStar	10772
Bell ExpressVu	10775
Chaparral	10216
Coolsat I	1806
Crossdigital I	1109
DirecTV	11377, 10392, 10566, 10639, 11639, 11142, 10247, 10749, 11749, 10724, 10819, 11856, 11076, 11108, 10099, 11109, 11414, 11442, 11609, 11392, 11640

Dish Network System	11505, 11005, 10775, 11170, 11775
Dishpro	11505, 11005, 10775, 11775
Echostar	11505, 11005, 10775, 11170, 11775
Expressvu	10775, 11775
Fortec Star	11821
Funai	11377
GE	10392, 10566
General Instrument	10869
GOI	10775, 11775
Hitachi	10749, 10819
Houston	10775
HTS	10775, 11775
Hughes Network Systems	11142, 10749, 11749, 11442
Humax	11790
Innova	10099
Jerrold	10869
JVC	10775, 11170, 11775
LG	11226, 11414
Magnavox	10724, 10722
McIntosh	10869
Memorex	10724
Mitsubishi	10749
Motorola	10869
Netsat	10099
Next Level	10869
Optimus	10724
Panasonic	10247, 10701
Pansat	11807
Paysat	10724
Philips	11142, 10749, 11749, 10775, 10724, 10819, 11076, 10722, 10099, 11442
Pioneer	11142, 11442
Primestar	10869
Proscan	10392, 10566
RadioShack	10566, 10775, 10869
RCA	10392, 10566, 11142, 10775, 10855, 10143, 11392, 11442
Samsung	11377, 11142, 11276, 11108, 11109, 11442, 11609
SKY	10099
Sony	10639, 11639, 11640
Star Choice	10869
Star Trak	10772, 10869
Thomson	10392, 10566
Tivo	11142, 11442
Toshiba	10749, 11749, 10790, 10819, 11285, 11286, 11287, 11289, 11857, 11858
UltimateTV	11392, 11640

(continued)

Chapter 3: Using the remote control

Ultrasat	11806
Uniden	10724, 10722
Voom	10869
Zenith	11856

DVDs

Brand	Code
3D LAB	20503, 20539
Accurian	21072, 21416
Advent	21016
Afreey	20698
Aiwa	20641
Akai	20695, 20705, 20770, 20899, 21089
Alba	20672, 20717
Alco	20790
Allegro	20869
Apex Digital	20533, 20672, 20717, 20755, 20794, 20796, 20797, 20830, 21004, 21020, 21056, 21061, 21100
Arrgo	21023
Aspire Digital	21168, 21407
Audiovox	20717, 20790, 21041, 21071, 21072, 21121, 21122
Axion	21071, 21072
Blaupunkt	20717
Blue Parade	20571
Blue Sky	20695
Bose	21895
Brandt	20651
Broksonic	20695, 20868
California Audio Labs	20490
Celestial	21020
Centrex	20672, 21004
Cinea	20831
CineVision	20876, 20833, 20869
Citizen	21003, 21277
Clairtone	20571
Coby	20778, 21086, 21107, 21177
Craig	20831
Creative	20503, 20539
Curtis Mathes	21087
CyberHome	20816, 20874, 21023, 21024, 21117, 21129, 21502
Cytron	20705
Daewoo	20784, 20705, 20770, 20833, 20869, 21169, 21172, 21234, 21242
Dansai	20770
Decca	20770
Denon	20490, 20634
Denver	20778
Desay	21407

Digitrex	20672
Disney	20675, 21270
DiViDo	20705
Dual	20675, 21068
Durabrand	21127
DVD2000	20521
Electrohome	21003
Emerson	20591, 20675, 20821, 21268
Enterprise	20591
Entivo	20503, 20539
Enzer	20770
ESA	20821, 21268
Firstline	20651
Fisher	20670
Funai	20675, 21268, 21334
Gateway	21073, 21158
GE	20522, 20815, 20717
Go Video	20573, 20744, 20717, 20715, 20741, 20783, 20833, 20869, 21044, 21075, 21099, 21158, 21304, 21730
Go Vision	21071, 21072
GoldStar	20741, 20801, 20869
Goodmans	20790
Gradiente	20490, 20651
Greenhill	20717
Grundig	20539, 20705
Harman/Kardon	20582, 20702
Hitachi	20573, 20664, 21247
Hiteker	20672
Humax	21588
iLo	21348
Initial	20717
Insignia	21268
Integra	20571, 20627
IRT	20783
JBL	20702
Jensen	21016
JMB	20695
JVC	20558, 20623, 20867, 21164 20790
Kawasaki	20790
Kenwood	20490, 20534
KLH	20717, 20790, 21020, 21149
Kloss	20533
Koss	20651, 21061
Lasonic	20627, 20798
Lecson	21533
Lenoxx	21127
LG	20591, 20741, 20801, 20869
LiteOn	21058, 21158, 21416, 21440
Loewe	20511, 20741
Logix	20783
Magnasonic	20651, 20675

Magnavox	20503, 20539, 20646, 20675, 20821, 21268
Marantz	20503, 20539, 20675
McIntosh	21533
Medion	20651
Memorex	20695, 20831, 21270
Microsoft	20522, 21708
Minato	20752
Mintek	20839, 20717
Mitsubishi	21521, 20521
NAD	20591, 20741
Naiko	20770
NEC	20785, 20869
Nesa	20717
NexxTech	21402
Norcent	21003, 21107, 21265
Onkyo	20503, 20627, 20792
Optimus	20571
Orion	21854
Oritron	20651
Palsonic	20672
Panasonic	20503, 20490, 20571, 20703, 21362, 21462, 21490, 21762
Philips	20503, 20539, 20646, 20675, 20854, 21260, 21267, 21354
PianoDisc	21024
Pioneer	20525, 20571, 20631
Polaroid	21020, 21061, 21086
PolkAudio	20539
Portland	20770
Presidian	20675, 21072
Prima	21016
Proceed	20672
Proscan	20522
ProVision	20778
Qwestar	20651
Radionette	20741
RadioShack	20571
RCA	20522, 20571, 20717, 20790, 20822, 21022, 21132
Realistic	20571
Reoc	20752
Rio	20869
Rotel	20623
Rowa	21004
Saba	20651
Sampo	20698, 20752
Samsung	20490, 20573, 20744, 20820, 20899, 21044, 21075
Sansui	20695
Sanyo	20670, 20675, 20695, 20873, 21334

Chapter 3: Using the remote control

Schneider	20783
Schwaiger	20752
Sensory Science	21158
Sharp	20630, 20675, 20752, 21256
Sharper Image	21117
Sherwood	20770, 21043
Shinsonic	20533, 20839
Slim Art	20784
Sonic Blue	20573, 20715, 20783, 20869, 21099
Sony	20533, 21533, 20864, 21033, 21070, 21431
Sova	21122
Superscan	20821
SVA	20717
Sylvania	20675, 20821, 21268
Symphonic	20675, 20821, 21268, 21334
Tatung	20770
Teac	20571, 20717, 20790
Technics	20490, 20703
Technika	20770
Tevion	20651
Theta Digital	20571
Thomson	20522, 20511
Tivo	21503, 21588
Toshiba	20503, 20573, 20539, 20695, 21045, 21154, 21503, 21588, 21854
Unimax	20770
Universum	20591
Urban Concepts	20503, 20539
US Logic	20839
V	21064, 21226
Venturer	20790
Visio	21064, 21226
Vizio	21064, 21226
Xbox	20522, 21708
Yamaha	20490, 20539, 20545
Zenith	20503, 20591, 20741, 20869
Zeus	20784
Zoece	21265

DVD-R

Brand	Code
Accurian	21416
Apex Digital	21056
Aspire Digital	21168
Coby	21086
CyberHome	21129, 21502
Funai	20675, 21334
Gateway	21073, 21158
Go Video	20741, 21158, 21304, 21730
iLo	21348
JVC	21164
LG	20741

LiteOn	21158, 21416, 21440
Magnavox	20646, 20675
Panasonic	20490
Philips	20646
Pioneer	20631
Polaroid	21086
RCA	20522
Samsung	20490
Sensory Science	21158
Sharp	20675
Sony	21033, 21070, 21431
Sylvania	20675
Zenith	20741

DVD/VCR Combo

Brand	Code
Allegro	20869
Apex Digital	21061
Broksonic	20695
CineVision	20833, 20869
Daewoo	20833, 20869
Emerson	20675
Funai	20675
Go Video	20744, 20715, 20741, 20833, 20869, 21044, 21075
GoldStar	20741
Hitachi	20664
JVC	20867, 21164
LG	20741
Magnavox	20675
Memorex	20695
Panasonic	21762
Philips	20675, 21267
Polaroid	21061
Presidian	20675
RCA	20522, 20822
Samsung	20820, 21044, 21075
Sansui	20695
Sanyo	20670, 20873
Sharp	20630
Sony	20864, 21033, 21070, 21431
Sylvania	20675
Symphonic	20675
Toshiba	20503, 21854
Zenith	20741, 20869
Emerson	31593
Funai	31593
Hitachi	30000
Magnavox	31593
Presidian	31593
RCA	30060
Sanyo	30104
Sharp	30848
Sylvania	30000, 30593, 31593
Symphonic	30000, 31593
Toshiba	41788

VCRs

Brand	Code
A-Mark	30037, 30240, 30000, 30278, 30046
ABS	31972
Admiral	30060, 30048, 30039, 30047, 30104, 30209, 30020, 30062, 30479
Adventura	30037, 30240, 30000
Adyson	30072
Aiko	30278
Aiwa	30037, 30000, 30124, 30307
Akai	30041, 30061, 30106, 30175
Alba	30209, 30072, 30278
Alienware	31972
Allegro	30039
America Action	30278
American High	30035, 30081
Amstrad	30000
Asha	30240
Astra	30035, 30240
Audiovox	30037, 30278, 30038
Avis	30000, 30072
Beaumarck	30240
Bell & Howell	30035, 30048, 30039, 30000, 30104, 30046, 30479
Broksonic	30184, 30121, 30209, 30002, 30208, 30479, 31479
Calix	30037
Candle	30037, 30038
Canon	30035
Capehart	30002, 30020, 30062
Carrera	30240
Carver	30035, 30081
CCE	30072, 30278
Cineral	30278
Citizen	30035, 30037, 30240, 30000, 30209, 30278, 30479, 31278
Classic	30037
Colortyme	30060, 30035, 30045, 30278
Colt	30000, 30072
Craig	30037, 30047, 30240, 30072, 30271
Criterion	30000, 30072
Crosley	30035, 30081, 30000, 30149
Crown	30072, 30278

(continued)

Chapter 3: Using the remote control

Curtis Mathes	30060, 30035, 30162, 30240, 30000, 30041, 30278, 30432, 30760, 31035	Harman/Kardon	30081, 30038	Memorex	30035, 30162, 30037, 30048, 30039, 30047, 30240, 30000, 30104, 30209, 30072, 30278, 30062, 30046, 30307, 30479, 31037, 31162, 31237, 31262
Cybernex	30240	Harvard	30072	Metz	30037
CyberPower	31972	Harwood	30072	MGA	30060, 30240, 30043, 30061
Daewoo	30037, 30045, 30278, 30020, 30046, 30561, 31278	Headquarter	30046	MGN Technology	30240
Daytron	30037, 30278, 30020	Hewlett Packard	31972	Microsoft	31972
Dell	31972	HI-Q	30035, 30047, 30000	Midland	30240
Denon	30081, 30042	Hitachi	30035, 30037, 30045, 30000, 30042, 30041, 30089, 30105	Mind	31972
Derwent	30041	Howard Computers	31972	Minolta	30042, 30105
DirecTV	30739	HP	31972	Mitsubishi	30060, 30048, 30047, 30000, 30042, 30067, 30043, 30041, 30061, 30807
Dual	30000	Hughes Network Systems	30042, 30739	Motorola	30035, 30048
Durabrand	30039, 30038	Humax	30739	Movie Walker	30072
Dynatech	30240, 30000	Hush	31972	MTC	30240, 30000, 30072
Electrohome	30060, 30037, 30240, 30000, 30043, 30209, 30061	Hytek	30047, 30000, 30072	MTX	30000
Electrophonic	30037	iBUYPOWER	31972	Multitech	30039, 30000, 30072
Emerald	30184, 30121	ITT Nokia	30240, 30041	NAD	30240, 30104
Emerex	30032	Janeil	30240	NEC	30104, 30067, 30041, 30038
Emerson	30037, 30184, 30240, 30000, 30121, 30043, 30209, 30002, 30278, 30202, 30208, 30061, 30479, 30561, 30593, 31278, 31479, 31593	Jensen	30067, 30041	New Tech	30072
Fisher	30039, 30047, 30000, 30104, 30046	JVC	30067, 30041, 30008, 30061, 31162	Nikko	30037, 30278
Fuji	30035, 30033	KEC	30037, 30278	Nikkodo	30037, 30278
Fujitsu	30000	Kenwood	30067, 30041, 30038, 30046	Nishi	30240
Funai	30037, 30000, 30072, 30278, 30593, 31593	KLH	30072	Niveus Media	31972
Garrard	30000	Kodak	30035, 30037	Noblex	30240
Gateway	31972	KTV	30000	Northgate	31972
GE	30060, 30035, 30048, 30240, 30000, 30149, 30202, 30760, 30807, 31035, 31060	LG	30037, 30240, 30038, 31037	Olympus	30035, 30162, 30104
Gemini	30060	Linksys	31972	Onkyo	30222
Genexxa	30037, 30000, 30278	Lloyd's	30240, 30000, 30072, 30038, 30208	Optimus	31062, 30035, 30162, 30037, 30048, 30047, 30240, 30000, 30104, 30062, 30432, 30593, 31048, 31162, 31262
Go Video	30240, 30432, 30526, 30614	Loewe	30081	Optonica	30062
GoldStar	30035, 30037, 30039, 30000, 30278, 30038, 31237	Logik	30240, 30000, 30072	Orion	30184, 30240, 30000, 30104, 30121, 30209, 30002, 30278, 30208, 30479, 31479
Goodmans	30037, 30081, 30000, 30072, 30278, 30020, 30062	Lumatron	30278	Panama	30035
Gradiente	30000, 30008	Luxor	30046, 30106	Panasonic	31062, 30035, 30162, 30000, 30020, 30225, 30614, 30616, 31035, 31162, 31262
Granada	30081, 30042	LXI	30037, 30000, 30042, 30067		
Grundig	30081	M Electronic	30240		
Harley Davidson	30000	Magnasonic	30037, 30240, 30000, 30072, 30278, 30020, 30593, 31278		
		Magnavox	30035, 30037, 30048, 30039, 30081, 30240, 30000, 30149, 30563, 30593, 30618, 31593, 31781		
		Magnin	30240		
		Marantz	30035, 30081, 30038, 30062		
		Marta	30037		
		Matsui	30037, 30209		
		Matsushita	30035, 30162, 30081, 31162		
		Media Center PC	31972		
		MEI	30035		

Chapter 3: Using the remote control

Penney	30035, 30162, 30037, 30047, 30081, 30240, 30000, 30042, 30067, 30038, 31035, 31237	Sansui	30240, 30000, 30067, 30209, 30041, 30072, 30002, 30271, 30479, 31479	Telecorder	30240
Pentax	30042, 30105	Sanyo	30047, 30240, 30000, 30104, 30046, 30159, 30479	Telefunken	30041, 30208
Philco	30035, 30081, 30000, 30209, 30479	Scientific Atlanta	30008	Tevion	30479
Philips	30035, 30162, 30048, 30081, 30045, 30000, 30209, 30062, 30616, 30618, 30739, 31081, 31181	Scott	30184, 30045, 30121, 30043, 30208, 30210	Thomas	30000, 30002
Pilot	30037	Sears	30060, 30035, 30162, 30037, 30048, 30039, 30047, 30033, 30045, 30000, 30042, 30104, 30067, 30043, 30209, 30041, 30072, 30046, 30105, 31237	Thomson	30060, 30041, 30202
Pioneer	30162, 30081, 30042, 30067	Sharp	30048, 30047, 30032, 30000, 30062, 30807, 30848	Tisonic	30278
Polk Audio	30081	Shintom	30039, 30240, 30000, 30072, 30208	Tivo	30618, 30636, 30739, 31996
Portland	30278, 30020	Shogun	30240	TMK	30240, 30000, 30208
Presidian	31593	Siemens	30037, 30104	TNIX	30037
Profitronic	30240	Signature	30060, 30035, 30037, 30048, 30000, 30149, 30046, 30479	Tocom	30240
Proscan	30060, 30202, 30760, 31060	Singer	30037, 30240, 30072	Toshiba	30240, 30045, 30000, 30043, 30209, 30041, 30062, 30210, 30845, 31008, 31145, 31972, 31996
Protec	30000, 30072	Sonic Blue	30614, 30616	Tosonic	30278
Protech	30072	Sonographe	30046	Totevision	30037, 30240
Pulsar	30039, 30240, 30278	Sony	30035, 30047, 30032, 30033, 30000, 30067, 30046, 30636, 31032, 31232, 31972	Touch	31972
Pulser	30240	Soundmaster	30000	Trix	30037
Quarter	30046	Stack 9	31972	Ultra	30045, 30278, 30020
Quartz	30035, 30047, 30046	STS	30042, 30105	Unitech	30240
Quasar	30035, 30162, 30002, 31035, 31162	SV2000	30000, 30072	Vector	30045
RadioShack	30035, 30162, 30037, 30048, 30047, 30240, 30000, 30104, 30046, 30062, 31037, 31162	SVA	30000	Vector Research	30184, 30038
Radix	30037	Sylvania	30035, 30081, 30000, 30043, 30593, 31593, 31781	Vextra	30072
Randex	30037	Symphonic	30240, 30000, 30002, 30593, 31593	Victor	30067, 30041, 30008
RCA	30060, 30035, 30048, 30240, 30045, 30000, 30042, 30149, 30105, 30106, 30202, 30760, 30807, 30880, 31035, 31060	Systemax	31972	Video Concepts	30045, 30061, 30210
Realistic	30035, 30162, 30037, 30048, 30047, 30240, 30000, 30104, 30121, 30278, 30046, 30062, 31162	Tagar Systems	31972	Videomagic	30037
ReplayTV	30614, 30616	Tandy	30000, 30104	Videosonic	30240, 30000, 30072
Ricavision	31972	Tatung	30048, 30081, 30000, 30067, 30041, 30008	Viewsonic	31972
Runco	30039	Teac	30000, 30067, 30041	Villain	30000
Samsung	30060, 30240, 30045, 30000, 30038, 30432, 30739, 31014	Technics	30035, 30162, 30037, 30000	Voodoo	31972
Samtron	30240	Teknika	30035, 30037, 30000	Wards	30060, 30035, 30037, 30048, 30047, 30081, 30033, 30240, 30045, 30000, 30042, 30043, 30041, 30072, 30038, 30149, 30046, 30062, 30479, 30760
Sanky	30048, 30039			Wharfedale	30593
				White Westinghouse	30000, 30209, 30072, 30278, 30479
				World	30209, 30002, 30479
				XR-1000	30035, 30240, 30000, 30072, 30208
				Yamaha	30041, 30038
				Zenith	30037, 30039, 30033, 30000, 30209, 30041, 30278, 30479, 31139, 31479
				ZT Group	31972

(continued)

PVRs

Brand	Code
ABS	31972
Alienware	31972
CyberPower	31972
Dell	31972
DirecTV	30739
Gateway	31972
Hewlett Packard	31972
Howard Computers	31972
HP	31972
Hughes Network Systems	30739
Humax	30739
Hush	31972
iBUYPOWER	31972
Linksys	31972
Media Center PC	31972
Microsoft	31972
Mind	31972
Niveus Media	31972
Northgate	31972
Panasonic	30616
Philips	30618, 30739
RCA	30880
ReplayTV	30614, 30616
Samsung	30739
Sonic Blue	30614, 30616
Sony	30636, 31972
Stack 9	31972
Systemax	31972
Tagar Systems	31972
Tivo	30618, 30636, 30739
Toshiba	31008, 31972, 31996
Touch	31972
Viewsonic	31972
Voodoo	31972
ZT Group	31972

Cable/PVR Combo

Brand	Code
Americast	10899
Amino	11822
Digeo	11187
Motorola/GI/Jerrold	10810
Motorola	11106, 11187, 11376
Myrio	11822
Pace	11877, 10237
Pioneer	11877, 10877
RCA	11256
Scientific Atlanta	11877, 10877
Sony	11006
Supercable	10276
Thomson	11256
Zenith	10899

DBS/PVR Combo

Brand	Code
DirecTV	11377, 10392, 10639, 11142, 11076, 10099, 11392, 11442, 11640
Dish Network System	11505, 10775
Dishpro	11505, 10775
Echostar	11505, 10775, 11170
Expressvu	10775
Hughes Network Systems	11142, 11442
JVC	11170
Motorola	10869
Philips	11142, 11442
Proscan	10392
RCA	11392
Samsung	11442
Sony	10639, 11640
Star Choice	10869
Hughes Network Systems	30739
Philips	30739
Samsung	30739

Audio Amp

Brand	Code
Adcom	40577
Bose	40674
Carver	40892
Curtis Mathes	40300
GE	40078
Harman/Kardon	40892
JVC	40331
Left Coast	40892
Marantz	40892
NEC	40264
Optimus	40013, 40300, 40823
Philips	40892
Pioneer	40013, 40300, 40823
Polk Audio	40892
RCA	40013, 40300, 40823
Realistic	40013
Shure	40264
Sony	40689, 40815
Soundesign	40078
Victor	40331
Wards	40078, 40013
Yamaha	40354, 40133

CD players

Brand	Code
Acoustic Research	50420
Aiwa	50157
Arcam	50157
Audio Research	50157
Burmester	50420
Cairn	50157
California Audio Labs	50029, 50303

Cambridge Soundworks	50157
Carver	50157, 50179
Curtis Mathes	50032
Denon	50003, 50034
DKK	50000
DMX Electronics	50157
Fisher	50000, 50179
Garrard	50420
Genexxa	50032
Grundig	50157
Hafler	50173
Harman/Kardon	50100, 50157, 50173
Hitachi	50032
Inkel	50157, 50180
Integra	50101
Jerrold	50003
JVC	50032, 50072
Kenwood	50626, 50000, 50029, 50028, 50037, 50190
KLH	51711
Krell	50157
Linn	50157
LXI	50179
Magnavox	50157, 50274
Marantz	50626, 50029, 50157, 50180
Matsui	50157
McIntosh	50256
MCS	50029
Memorex	50000, 50032, 50179, 50420, 50468
Micromega	50157
Miro	50000
Mission	50157
Modulaire	50000, 50032, 50087, 50179, 50180, 50420, 50468
MTC	50420
NSM	50157
Onkyo	51327, 50101
Optimus	50000, 50032, 50037, 50087, 50179, 50420, 50468
Panasonic	50029, 50303, 50388, 50752
Parasound	50420
Penney	50029
Philips	50626, 50157, 50274
Pioneer	51062, 50032, 51087, 50468
PolkAudio	50157
Proceed	50420
Proton	50157
QED	50157
Quad	50157
Quasar	50029
RadioShack	50000, 50032, 50179, 50180, 50420, 50468

Chapter 3: Using the remote control

RCA	51062, 50032, 50053, 50179, 50420, 50468
Realistic	50000, 50032, 50087, 50179, 50180, 50420, 50468
Revox	50157
Rotel	50157, 50420
SAE	50157
Sansui	50000, 50157
Sanyo	50000, 50087, 50179
Sears	50179
Sharp	50037, 50180
Sherwood	50180
Sonic Frontiers	50157
Sony	50490, 50000, 50100, 51364, 50185
Sugden	50157
Sylvania	50157
Symphonic	50180
TAG McLaren	50157
Tandy	50032
Tascam	50420
Teac	50490, 50180, 50420
Technics	50029, 50303
Techwood	50303
Thule Audio	50157
Victor	50072
Wards	50032, 50157, 50053, 50087, 50179
Yamaha	50490, 50036, 51292
Yorx	50000

Harman/Kardon	40110, 40189, 40891, 41289, 41304, 41306
Hitachi	41273, 41801
Integra	40135, 40842, 41298, 41320
JBL	40110, 41306
JVC	41058, 40074, 41374, 41495, 41811
Kawasaki	41390
Kenwood	41313, 41570, 41569, 40186
KLH	41390, 41428
Koss	41366, 41497
LG	41293
Linn	40189
Liquid Video	41497
Magnavox	41189, 41269, 40189, 40531, 41266, 41514
Marantz	41189, 41269, 40189, 40891, 41289
McIntosh	41289
Micromega	41189, 40189
Mitsubishi	41393
Myryad	41189
Nakamichi	41313
Onkyo	40135, 40842, 41298, 41320, 41531
Optimus	41023, 40074, 40014, 40121, 40186, 40531, 41074
Oritron	41366, 41497
Panasonic	41308, 41518, 40309, 41288, 41316, 41548, 41633, 41763, 41764
Philips	41189, 41269, 40189, 40891, 41266
Pioneer	41023, 40014, 40150, 40531, 40630, 41384
Polaroid	41508
Polk Audio	40189, 41289
Proscan	41254
RadioShack	41609
RCA	41023, 41609, 41254, 40531, 41074, 41390, 41511
Realistic	41609, 40121, 40186
Revox	40189
Samsung	41295, 41304, 41500
Sansui	41189, 40189
Sanyo	41251, 41469, 41801
Sharp	40186
Sherwood	41077
Sirius	41811

Sony	41058, 41441, 41258, 41622, 41658, 41758, 41858
Stereophonics	41023
Sunfire	41313
Teac	41074, 41390
Technics	41308, 41518, 40309, 41633
Thorens	41189
Toshiba	40135, 40842, 41788
Venturer	41390
Victor	40074
Wards	40189, 40014
Yamaha	41023, 40176, 40186, 41176, 41276, 41331, 41375
Zenith	41293

Audio Amp/Tuners







Brand	Code
ADC	40531
Aiwa	41405, 40189, 40121, 41388, 41641
Alco	41390
AMC	41077
Anam	41609, 41074
Apex Digital	41774
Arcam	41189
Audiotronic	41189
Audiovox	41390
B&K	40701, 40820
Bose	41229, 40639, 41253, 41933
Cairn	40189
Capetronic	40531
Carver	41189, 40189, 40121, 41289
Curtis Mathes	40014
Denon	41360, 40121, 40771, 41142, 41306
Emerson	40531
Fisher	41801
Grundig	40189

Chapter 4: Menu layout and navigation

Main menu layout

The tables below and on the next page provide a quick overview of your TV's menu system.



To open the main menus (illustrated below), press  on the remote control or TV control panel.

Icon	Item	Option	Page
	Picture Viewer	→ [Launches the JPEG Picture Viewer]	96
	Audio Player	→ [Launches the MP3 Audio Player]	98
	Personal E-mail	→ [Launches Personal E-mail]	102
	Channel Browser™	→ [Launches the Channel Browser™]	53
	Help	→ [Opens the Help menu]	85
	Start Demo	→ [Launches Demo Mode]	43
	Mode	→ Sports/Standard/Movie/Document/Preference/Pro1/Pro2	60
	Picture Settings	→ [Opens the Picture Settings menu]	61
	Noise Reduction	→ [Opens the Noise Reduction menu]	80
	ColorMaster Pro	→ [Opens the ColorMaster Pro menu]	81
	xvYCC Selection	→ Auto/On/Off	83
	Game Mode	→ On/Off	83
	Theater Settings	→ [Opens the Theater Settings menu]	56
	TheaterLock™	→ On/Off	61
	Digital Audio Selector	→ [Launches the temporary Audio Selector]	64
	Audio Settings	→ [Opens the Audio Settings menu]	65
	Advanced Audio Settings	→ [Opens the Advanced Audio Settings menu]	84
	Audio Setup	→ [Opens the Audio Setup menu]	64
	CC Selector	→ [Launches the temporary CC Selector]	63
	Base CC Mode	→ Off/CC1/CC2/CC3/CC4/T1/T2/T3/T4	62
	Digital CC Settings	→ [Opens the Digital CC Setup menu]	63
	Auto Input	→ [Opens the Auto Input Setup menu]	46
	Input Labeling	→ [Opens the Input Labeling menu]	52
	Channel Labeling	→ [Opens the Channel Labeling menu]	47
	Menu Language	→ English/French/Spanish	43
	Channel Browser Setup	→ [Opens the Channel Browser Setup menu]	53
	Enable Rating Blocking	→ Off/On	68
	Edit Rating Limits	→ [Opens the Edit Rating Limits menu]	68
	Channels Block	→ [Opens the Channels block menu]	69
	Input Lock	→ Off/Video/Video+	70
	Front Panel Lock	→ Off/On	71
	GameTimer®	→ Off/30 Min/60 Min/90 Min/120 Min	71
	New PIN Code	→ [Opens the New PIN Code entry screen]	67
	Installation	→ [Opens the Installation menu]	44
	CE-Link Setup	→ [Opens the CE-Link Setup menu]	75
	Sleep Timer	→ [Opens the Sleep Timer menu]	73
	HDMI Settings	→ [Opens the HDMI Settings menu]	75
	PC Settings	→ [Opens the PC Settings menu]	72
	Slide Show Interval	→ 2 Sec/5 Sec/10 Sec/15 Sec/20 Sec	97
	Power-On Mode	→ Power-Saving/Fast	50
	Demo Mode	→ On/Off	50

Setup/Installation menu layout

The Installation menu contains the Terrestrial, Network, and System Status menus.

To open the **Installation** menu (illustrated below), press **MENU** on the remote control or TV control panel, open the **Setup** menu, select **Installation**, and press **ENTER**.

	Icon	Item	Option	Page
Press MENU , open the Setup menu, and then open the Installation sub-menu.	Terrestrial 	Input Configuration	→ [Opens the Input Configuration menu]	44
		Channel Program	→ [Start] → [Scans for new channels on ANT]	44
		Channel Add/Delete	→ [Opens the Channel Add/Delete menu]	45
		Signal Meter	→ [Opens the Signal Meter menu]	49
	Network 	Basic Network Setup	→ [Opens the Basic Network Setup menu]	88
		Personal E-mail Setup	→ [Opens the Personal E-mail Setup menu]	99
		Home File Server Setup	→ [Opens the Home File Server Setup menu]	93
		Software Upgrade	→ [Opens the Software Upgrade menu]	94
	System Status 	System Information	→ [Opens the System Information screen]	49

THINC™ menu

The THINC* menu provides access to the **CE-Link Player Control**, **Picture Viewer**, **Audio Player**, **Personal E-mail**, **Channel Browser**, and **Favorites Browser** features.

The THINC menu is not part of the main menu system. You can only view the THINC menu by pressing **THINC** on the remote control.

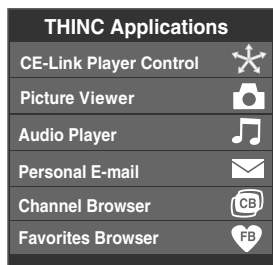

* Toshiba Home Interactive Network Connection.

Navigating the menu system

You can use the buttons on the remote control or TV control panel to access and navigate your TV's on-screen menu system.

- Press **MENU** to open the menu system.
- When a menu is open, use the up/down/left/right arrow buttons (**▲▼◀▶**) on the remote control or TV control panel to move in the corresponding direction in the menu.
- Press **ENTER** to save your menu settings or select a highlighted item. (A highlighted menu item appears in a different color in the menu.)
- All menus close automatically if you do not make a selection within 60 seconds, except the signal meter menu, which closes automatically after about 5 minutes.
- To close a menu instantly, press **EXIT**.

Note: The menu background may sometimes appear black, depending on the signal the TV is receiving. This is not a sign of malfunction.

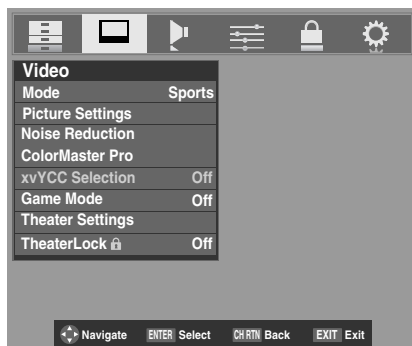

Chapter 5: Setting up your TV

Setting the Demo Mode

When you first turn on the TV, menu language selection and Demo Mode selection windows will appear by default.

To select settings:

- 1 From the menu language selection window, select your preferred language.



- 2 Highlight **OK** and press **ENTER**. Next the Demo Mode setting window will appear.

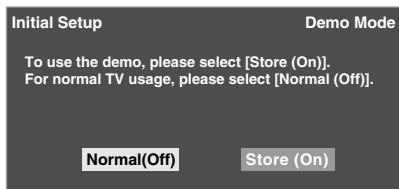

For normal TV usage, select **Normal (Off)**.

If you do not make a selection within 120 seconds, the Demo Mode setting window will automatically disappear. The TV will switch to Normal mode.

To enable the on-screen demonstration, select **Store (On)**. The ClearFrame™ demonstration window will display for 60 seconds. To restart the on-screen demonstration, press **MENU** on the remote or on the TV for 2 seconds.

Note: The on-screen demonstration will automatically restart if you do not make a selection within 120 seconds.

To exit the demo mode:

Press **MENU** and **VOLUME** buttons on the TV control panel at the same time and hold for about 2 seconds, or set **Demo Mode** to **Off** in the **Setup** menu (page 50).

Selecting the menu language

You can choose from three different languages (English, French and Spanish) for the on-screen display of menus and messages.

To select the menu language:

- 1 Press **MENU** and open the **Preferences** menu.
- 2 Highlight **Menu Language** and press **▶**.
- 3 Press **▲** or **▼** to select your preferred menu language and press **ENTER**.



- 4 Press **EXIT** to close the **Preferences** menu.

Configuring the antenna input source for the ANT terminal

To configure the ANT input source:

- 1 Press **MENU** and open the **Setup** menu.
- 2 Highlight **Installation** and press **ENTER**.

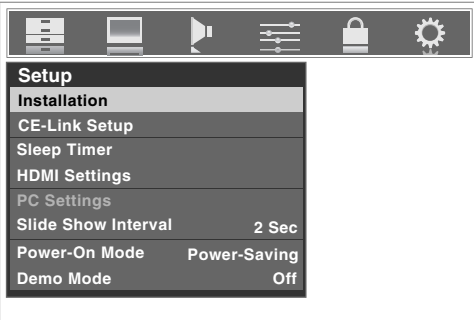

- 3 (A new set of **Installation** menu icons will appear, as shown below.) Open the **Terrestrial** menu, highlight **Input Configuration**, and press **ENTER**.

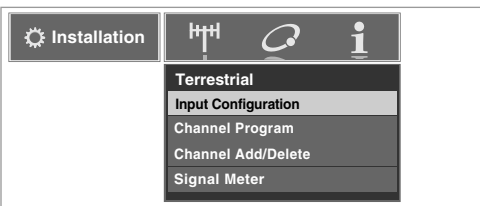

- 4 Press **◀** or **▶** to select the input source (**Cable** or **Antenna**) for the **ANT** input on the TV.



- 5 To save your new settings, highlight **Done** and press **ENTER**. To revert to your original settings, highlight **Cancel** and press **ENTER**.

Programming channels into the TV's channel memory

When you press **CH** or **CH** on the remote control or TV control panel, your TV will stop only on the channels you programmed into the TV's channel memory.

Follow the steps below to program channels into the TV's channel memory.

Programming channels automatically

Your TV can automatically detect all active channels in your area and store them in its memory. After the channels are programmed automatically, you can manually add or erase individual channels in the channel memory.

Note:

- You must configure the antenna input source before programming channels (**↶** at left).
- If the Antenna input signal type is set to **Cable**, the automatic channel programming process erases channels that were previously programmed into the TV's memory.
- If the Antenna input signal type is set to **Antenna**, the automatic channel programming process adds newly found channels to the existing set of programmed channels (and does NOT erase channels that were previously programmed into the TV's memory.) To remove an Antenna source channel from the memory, you must manually delete it.
- To tune the TV to a channel not programmed in the channel memory, you must use the Channel Number buttons on the remote control.
- Programming channels when the antenna input is configured for **Cable** will take substantially longer than when the antenna input is configured for **Antenna**. This is normal; however, once channel programming is finished, you should not have to repeat the programming process again unless your Cable TV service lineup changes significantly.

To program channels automatically:

- 1 Configure the antenna input source, if you have not already done so (**↶** at left).
- 2 Press **MENU** and open the **Setup** menu.
- 3 Highlight **Installation** and press **ENTER**.

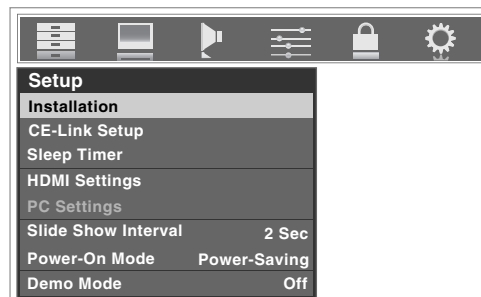

- 4 (A new set of **Installation** menu icons will appear, as shown below.) Open the **Terrestrial** menu, highlight **Channel Program** to bring up the **Start**, and press **ENTER** again to begin channel programming.

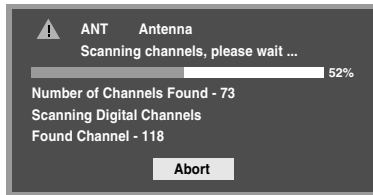
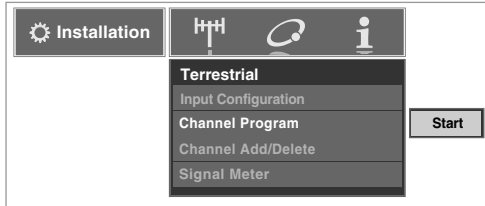

The TV will automatically cycle through all the antenna channels, and store all active channels in the channel memory. While the TV is cycling through the channels, the message “Scanning channels, please wait” appears (as shown above).

- 5 To cancel channel programming, press **EXIT** on the remote control (or highlight **Abort** in the on-screen display and press **ENTER**).
When channel programming is finished, press **CH** or **CH** to view the programmed channels.

Manually adding and deleting channels in the channel memory

After automatically programming channels into the channel memory, you can manually add or delete individual channels.

To add or delete channels in the channel memory:

- 1 Press **MENU** and open the **Setup** menu.
- 2 Highlight **Installation** and press **ENTER**.
- 3 (A new set of **Installation** menu icons will appear, as shown below.) Open the **Terrestrial** menu, highlight **Channel Add/Delete**, and then press **ENTER**.

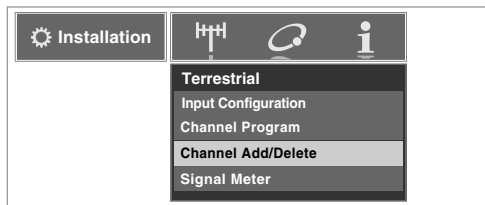

To add a channel to the channel memory:

Highlight the unchecked box next to the channel number you want to add, and then press **ENTER** to check the box.

To manually add digital subchannels on a physical channel:

Use the Channel Numbers and the Dash (**100**) on the remote control to enter the channel number (for example, 56-1).

If the channel is found, the number will be added to the list and the box will be checked.

If the channel is not found, a message will appear.

To remove a channel from the channel memory:

Highlight the checked box next to the channel number you want to remove, and then press **ENTER** to uncheck the box.

To save your new settings:

Highlight **Done** and press **ENTER**.

To revert to your original settings:

Highlight **Cancel** and press **ENTER** before saving.

To remove all channels from the channel memory:

Highlight **Reset** and press **ENTER**, and then highlight **Done** and press **ENTER**.

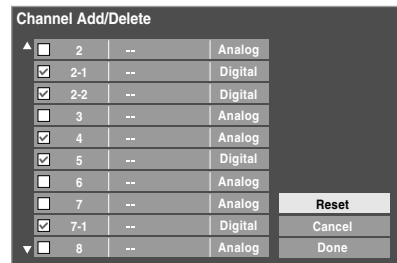

To remove encrypted channels from the channel memory:

If an encrypted channel is accidentally added to the channel list by programming channels, you can remove the unwanted encrypted (non-viewable) channel while you are channel surfing. When you tune to an encrypted channel, the following message will appear.

Digital Channel Is Encrypted - Press 1 on remote to remove channel

Press “**1**” button while the message is on the screen to remove the unnecessary channel from the channel list.

Setting the Auto Input feature

This feature allows you to change TV inputs using the mode select buttons—**TV**, **CABLE/SAT**, **DVD**, **VCR/PVR**, **AUX1**, **AUX2**—on the remote control. Once an input has been set for a specific mode select button, the TV will automatically switch to that input when that mode select button is pressed.

Auto Input settings options for each mode select button are shown below.

- **TV:** ANT
- **CABLE/SAT:** ANT, Video 1, Video 2, ColorStream HD1, ColorStream HD2, HDMI 1, HDMI 2, HDMI 3, PC
- **DVD:** Video 1, Video 2, ColorStream HD1, ColorStream HD2, HDMI 1, HDMI 2, HDMI 3, PC
- **VCR/PVR:** ANT, Video 1, Video 2, ColorStream HD1, ColorStream HD2, HDMI 1, HDMI 2, HDMI 3, PC
- **AUX1:** Video 1, Video 2, ColorStream HD1, ColorStream HD2, HDMI 1, HDMI 2, HDMI 3, PC
- **AUX2:** Video 1, Video 2, ColorStream HD1, ColorStream HD2, HDMI 1, HDMI 2, HDMI 3, PC

Note: The TV mode select button will be restricted to the ANT input.

To set the Auto Input:

- 1 Press **MENU** and open the **Preferences** menu.
- 2 Highlight **Auto Input** and press **ENTER**.

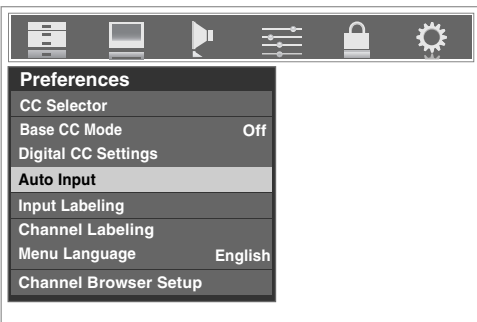

- 3 Press **▲** or **▼** to highlight **Enable Auto Input** and then press **◀** or **▶** to select **On**.

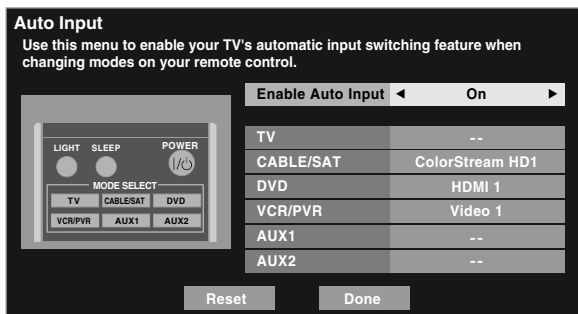

- 4 Press **▲** or **▼** to select the mode field you want to set.

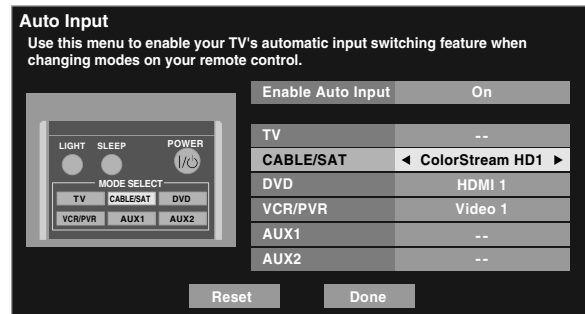

- 5 Press **◀** or **▶** to select the desired input source for that mode.
- 6 Repeat steps 4 and 5 for other modes.
- 7 To save your settings, highlight **Done** and press **ENTER**.

To turn off the Auto Input:

Select **Off** in step 3.

Note: Setting the feature to **Off** will not cancel any settings; however, all items will be grayed out.

To reset Auto Input:

- 1 Press **MENU** and open the **Preferences** menu.
- 2 Highlight **Auto Input** and press **ENTER**.
- 3 Highlight **Reset** and press **ENTER**.

Labeling channels

A list of common channel labels (logos) for various channels (ABC, CBS, etc.) will be programmed into the TV. You will be able to view and assign these logos from the **Channel Labeling** window. If the desired channel label is not provided in the list, you will be able to manually enter/edit labels using the software keyboard.

To assign channel labels:

- 1 Press **MENU** and open the **Preferences** menu.
- 2 Highlight **Channel Labeling** and press **ENTER**.
The **Channel Labeling** window opens.

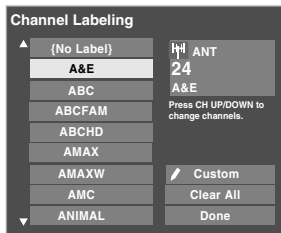
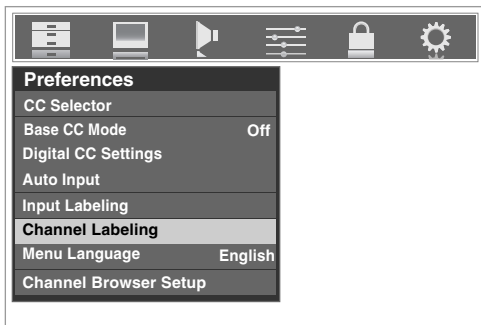

- 3 Press **CH** or **CH** to select the channel you want to label.
- 4 Press **▲▼◀▶** to highlight the desired channel label and press **ENTER**.
- 5 Repeat steps 3 and 4 for other channels.
- 6 To save your settings, highlight **Done** and press **ENTER**.

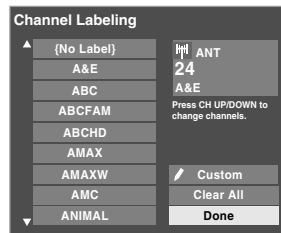

The maximum number of labels that can be stored is 128.

To remove channel labels:

- 1 Open the **Channel Labeling** window.
- 2 Press **CH** or **CH** to select the channel for which you want to remove the label.
- 3 Press **▲▼◀▶** to highlight **No Label** and press **ENTER**.



- 4 Repeat steps 2 and 3 for other channels.
- 5 To save your settings, highlight **Done** and press **ENTER**.

If the desired channel label is not available from the list of presets, you can create a custom label.

To create and assign a custom label:

- 1 Open the **Channel Labeling** window.
- 2 Press **CH** or **CH** to select a channel you want to label.
- 3 Press **▲▼▶** to highlight **Custom** and press **ENTER**.
The software keyboard will appear.

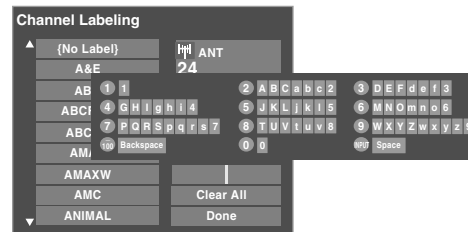

- 4 Repeatedly press the corresponding key on the remote control to highlight the desired character on the on-screen software keyboard.
- 5 The highlighted character is entered after you either press a different key, press **▶** key, or after a two-second pause.
- 6 Repeat steps 4 and 5 until you have entered all desired text.
- 7 When finished, press **ENTER**.
- 8 (New labels will be added to the list in alphabetical order and marked with an icon **✍** to indicate that they are custom.) Highlight the new custom label and press **ENTER** to assign.

Assigned channel labels will be displayed in the banner, **Channel Add/Delete** window, and **Channels Block** window.

To delete the custom label:

- 1 Open the **Channel Labeling** window.
- 2 Highlight the label to be deleted and press **100**.
- 3 Highlight **Yes** from the deletion confirmation window and press **ENTER**.

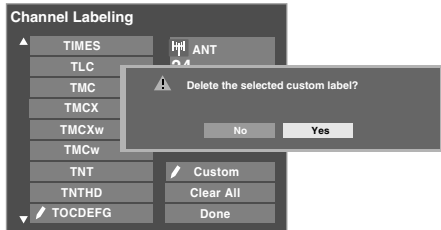

- 4 Highlight **Done** and press **ENTER** to save changes, and go back to the **Channel Labeling** window.

Setting the HDMI™ audio mode**To set the HDMI audio mode:**

- 1 Press **MENU** and open the **Audio** menu.
- 2 Highlight **Audio Setup** and press **ENTER**.
- 3 Press **▲** or **▼** to select **HDMI 1 Audio** and then press **◀** or **▶** to select the HDMI 1 audio mode (**Auto**, **Digital**, or **Analog**). (**Auto** is the recommended mode.) See “Connecting an HDMI or DVI device to the HDMI input” (page 20).

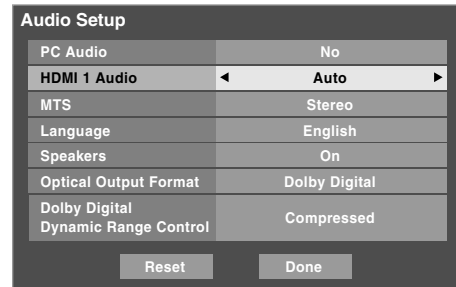

Note: Because the PC and HDMI-1 inputs share the same set of analog audio inputs, the **PC Audio** menu setting influences the **HDMI 1 Audio** menu setting. If **PC Audio** is set to “**No**,” the **HDMI 1 Audio** setting changes to “**Auto**.” If **PC Audio** is set to “**Yes**,” the **HDMI 1 Audio** setting is set to “**Digital**” and is grayed out in the menu. (Also see item 5 on page 12 and “Setting the PC Audio” on page 72.)

Viewing the digital signal meter

You can view the digital signal meter in the ANT digital TV input source only.

To view the digital signal meter:

- 1 Press **MENU** and open the **Setup** menu.
- 2 Highlight **Installation** and press **ENTER**.
- 3 A new set of Installation menu icons will appear, as shown below. Open the **Terrestrial** menu, highlight **Signal Meter**, and press **ENTER**.

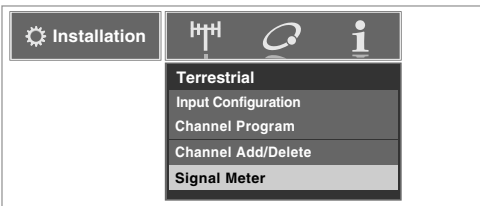

- 4 Press **▲▼◀▶** to select the antenna input and digital channel whose signal you want to check.

Note: The physical digital channel number listed in the Signal Meter screen may not correspond to a virtual TV channel number. Contact your local broadcasters to obtain the RF channel numbers for your local digital stations.

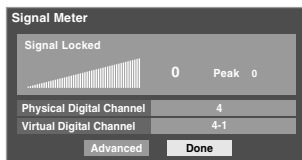

To close the screen and return to the Terrestrial menu:

Highlight **Done** and press **ENTER**.

To return to normal viewing:

Press **EXIT**.

Viewing the system status

To view the system status:

- 1 Press **MENU** and open the **Setup** menu.
- 2 Highlight **Installation** and press **ENTER**.
- 3 A new set of Installation menu icons will appear, as shown below. Open the **System Status** menu, highlight **System Information**, and press **ENTER**.

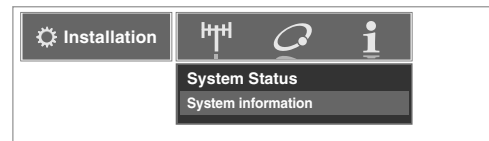

- 4 Press **◀▶** to scroll through the menu bar to select the **Software Version** and view the related information.

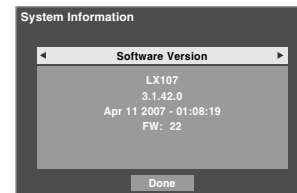

To close the screen and return to the Installation menu:

Highlight **Done** and press **ENTER**.

To return to normal viewing:

Press **EXIT**.

Reset Factory Defaults

To reset all settings and channels to their factory default values:

- 1 Press **MENU** and open the **Setup** menu.
- 2 Highlight **Installation** and press **ENTER**. A new set of Installation menu icons will appear.
- 3 Open the **System Status** menu, highlight **System Information**, and press **ENTER**.
- 4 Press **◀▶** to scroll through the menu bar to select **Factory Defaults**.

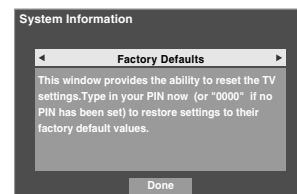

- 5 Enter your PIN code (or 0000 if no PIN code has been set).

(continued)

- 6 Highlight **Yes** and press **ENTER**. The TV will turn off automatically after a few seconds. After the TV turns off, unplug the TV power cord and then plug it in again to complete the reset process.

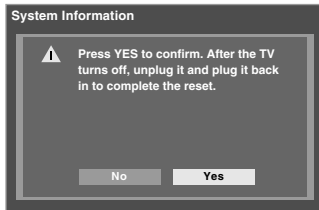

To cancel the reset:

Highlight **No** and press **ENTER**.

Selecting the Power-On Mode

You can select either **Power-Saving** or **Fast** mode.

- **Power-Saving** mode keeps power consumption in standby mode to below 3W. As a result, it takes a bit longer for the TV to turn on.
- **Fast** mode increases power consumption in standby mode. As a result, the TV will turn on more quickly. While in **Fast** mode, the yellow LED on the front of the TV will be lit.

To set the Power-On Mode feature:

- 1 Press **MENU**, and open the **Setup** menu.
- 2 Highlight **Power-On Mode** and press **▶**.
- 3 Press **▲** or **▼** to select either **Power-Saving** or **Fast**.

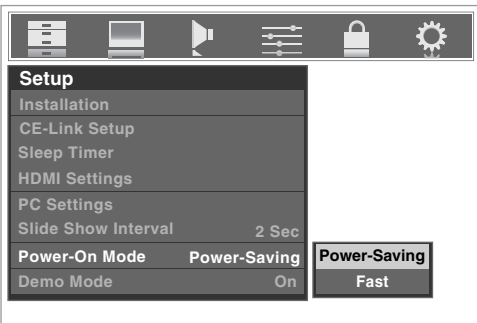

Selecting the Demo Mode

You can select the TV's demo mode on or off. This feature is provided for demonstrational purposes only.

To select the Demo Mode:

- 1 Press **MENU**, and open the **Setup** menu.
- 2 Highlight **Demo Mode** and press **▶**.
- 3 Press **▲** or **▼** to select either **On** or **Off**.

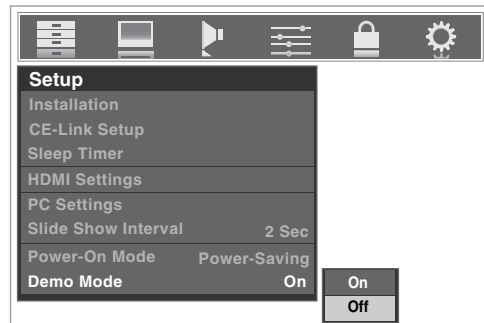

Note: If the demo mode has been set to **On**, the Demo mode will run automatically when you turn on the TV.

Selecting the video input source to view

To select the video input source to view:

- 1 Press **INPUT** on the remote control or TV control panel.
- 2 And then either:
 - a) Press 0–8; or
 - b) Repeatedly press **▲▼** on the remote control and then press **ENTER** to change the input; or
 - c) Repeatedly press **INPUT** on the remote control or TV control panel to change the input.

The current signal source displays in the top right corner of the **Input Selection** screen.

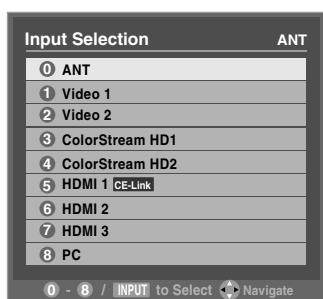

Note:

- You can label the video input sources according to the specific devices you have connected to the TV (see "Labeling the video input sources" on the next page).
- Sources can also be "hidden" (see "Labeling the video input sources" on the next page).
- "No Video Signal" will appear randomly on the screen if no signal is received in video input mode.
- If a CEC device is connected to an HDMI input, the CE-Link icon will appear.

If a CE-Link device with HDMI switching capability (e.g. Audio Receiver) is connected to the HDMI input:

Press **INPUT** on the remote or TV control panel repeatedly to highlight **HDMI 1**, **HDMI 2**, or **HDMI 3**.

If the connected CEC device has any connected devices, a separate device selection popup window will appear.

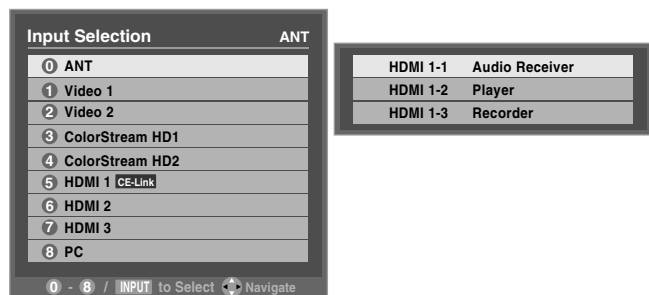

Press **INPUT** repeatedly to highlight a desired input source, and then press **EXIT**.

Note:

- If you select the CE-Link input source from the popup window using **INPUT**, some CE-Link devices may automatically turn on.
- When selecting the input source using **▲▼**, you will have to press **ENTER** to actually select a particular device from the popup window.

To switch the video input source using the mode select buttons:

Press **CABLE/SAT**, **DVD**, **VCR/PVR**, **AUX1**, **AUX2**.

Note: To use this function, you must set up the **Auto Input** feature (see page 46).

Labeling the video input sources

You can label each video input source according to the type of device you connected to each source, from the following preset list of labels:

- -- (default label)
- Audio Receiver
- Cable
- Compact Disc
- DTV
- DVD
- Game Console
- HD DVD
- HDMI Switch
- Laser Disk
- Satellite/DSS
- VCR
- Video Recorder
- Hide (to hide an unused input in the **Input Selection** screen and in the Channel Browser Inputs list)

Note: If you select PC in the Input Selection screen, you can choose only "--" or "Hide" as the label.

To label the video input sources:

- 1 Press **MENU** and open the **Preferences** menu.
- 2 Highlight **Input Labeling** and press **ENTER**.

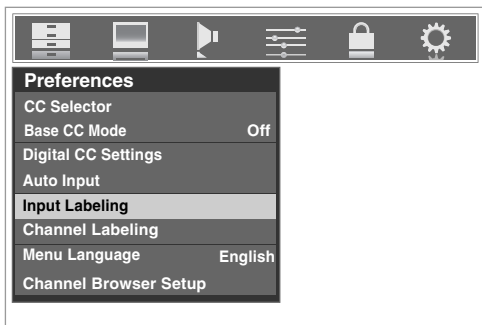

- 3 Press **▲** or **▼** to highlight the video source you want to label.



- 4 Press **◀** or **▶** to select the desired label for that input source. If a particular input is not used, you can select **Hide** as the label, which will cause that input to be "grayed out" in the Input Selection screen and skipped over when you press **INPUT** on the remote control.
- 5 To save the new input labels, highlight **Done** and press **ENTER**.
To revert to the factory default labels, highlight **Reset** and press **ENTER**.

Input labeling example:

The screen below left shows the default **Input Selection** screen (with none of the inputs labeled as a specific device). The screen below right is an example of how you could label the inputs if you connected a VCR to VIDEO 1, Cable TV to VIDEO 2, a video recorder to ColorStream HD1, a DTV set-top box to HDMI 1, a satellite/DSS set-top box to HDMI 2, and a DVD player to HDMI 3. Also note that the ColorStream HD2 input is labeled "Hidden," which means that input will be skipped over when **INPUT** is pressed.

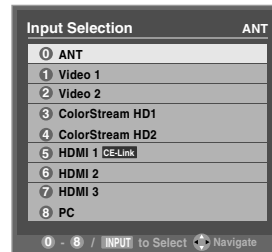

Input Selection screen with no inputs labeled.

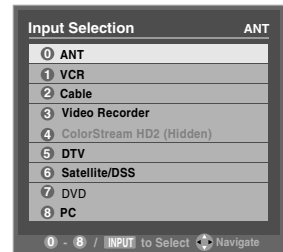

Input Selection screen with all inputs labeled except input 4, which has been hidden.

To clear the input labels:

- 1 Press **MENU** and open the **Preferences** menu.
- 2 Highlight **Input Labeling** and press **ENTER**.
- 3 Highlight **Reset** and press **ENTER**.

Tuning channels

Tuning channels using the Channel Browser™

The Channel Browser™ provides an easy navigation interface for all your channels and inputs. This feature allows you to:

- Navigate the contents of all of your inputs.
- Keep a list of your favorite channels (see “Favorites Browser,” below).
- Keep a history of the last 32 channels or inputs viewed.
- Quickly surf and tune your recently viewed channels/inputs from the Channel Browser™ History List (illustrated on the next page).
- Surf via Browse mode (to immediately tune channels as you highlight them in the Channel Browser™) or Select mode (to surf over channels in the Channel Browser™ before you select one to tune).
- Quickly change inputs from the Inputs List.

Favorites Browser

The Favorites Browser allows you to quickly set up a favorite channels/inputs list that is integrated into the Channel Browser™.

To add a favorite channel/input:

- 1 Tune to the channel or input.
- 2 Press and hold **CH BROWSER** for 3 seconds.

Note: Additions are added to the beginning of the Favorites list on the left side of the Channel Browser™.

To delete a favorite channel/input:

- 1 Press **CH BROWSER** to open the Favorites browser list.
- 2 Highlight the channel or input to delete by pressing **BACK** or **NEXT**.
- 3 Press and hold **100** for 3 seconds. The channel/input will be removed from the Favorites list.

Picture Preview

- A small thumbnail preview of the current channel or input will appear in the list.
- Picture snapshots will be taken when a source change occurs from the Channel Browser™.
- Up to 32 picture previews can be stored in the Channel Browser™ across all lists. If you add a new picture when the total = 32, the oldest thumbnail will be deleted. One thumbnail is counted only once against the total, no matter how many times it appears in various lists.
- Turning off the TV deletes all of the current thumbnails.

To set up the Channel Browser™:

- 1 Press **MENU** and open the **Preferences** menu.
- 2 Highlight **Channel Browser Setup** and press **ENTER**.
- 3 Press **▲** to highlight **Navigation**, and then press **◀** or **▶** to select either **Browse Mode** or **Select Mode**.

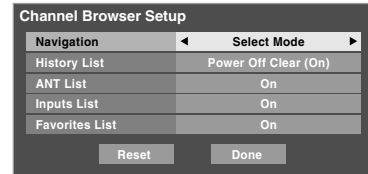

- 4 Press **▼** to highlight **History List**, and then press **◀** or **▶** to select the setting you prefer: either **Power Off Clear (On)**, **On**, or **Off**.

Note: When **History List** is set to **On** and the **Power-On Mode** (see page 50) is in **Fast** mode, the channels and inputs stored in the list will be saved every power on/off cycle. When **History List** is set to **Power Off Clear (On)**, the channels and inputs stored in the list will be cleared with every power on/off cycle of the TV.

- 5 Press **▼** to highlight **ANT List**, and then press **◀** or **▶** to select **On** or **Off**.
- 6 Press **▼** to highlight **Inputs List**, and then press **◀** or **▶** to select **On** or **Off**.
- 7 Press **▼** to highlight **Favorites List**, then press **◀** or **▶** to select **On** or **Off**.
- 8 To save your entries, highlight **Done** and press **ENTER**. To return to factory defaults, highlight **Reset** and press **ENTER**.

(continued)

To open the Channel Browser™:

- Press **BACK** ◀ or **NEXT** ▶ on the remote control.
- Press **BACK** ◀ to surf backward through the previously tuned 32 channels in the History list, the channels in the ANT channel list, the inputs in the Inputs list, or the favorite channels/inputs in the Favorites list.
- Press **NEXT** ▶ to surf forward through the channel History, the ANT channel list, the Inputs list, or the favorite channels/inputs in the Favorites list.

Elements of the Channel Browser™

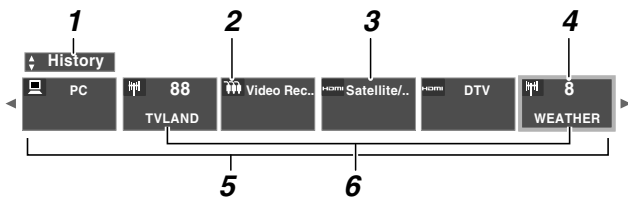

- 1 Current list (**History**, **ANT**, **Inputs**, or **Favorites**)
- 2 Input type
- 3 Channel or input currently being viewed
- 4 Channel or input that is currently highlighted in the browser
- 5 Channels stored in the History List
- 6 Channel labels

To toggle among the available lists:

After opening the Channel Browser™, press ▲ or ▼ to toggle among **History**, **ANT**, **Inputs**, and **Favorites**.

Note:

- The Channel Browser™ opens in **History List** by default. Once another list has been selected, the Channel Browser™ will open in the last selected list.
- If all lists are turned off, pressing **BACK** ◀, **NEXT** ▶, or **CH BROWSER** will not display the Channel Browser™. If **Favorites List** is turned off, **CH BROWSER** will have no effect.
- Pressing **CH BROWSER** will bring up the Channel Browser™ Favorites list regardless of the last selected list in the Channel Browser™.

To tune to a channel or input in Browse mode:

- 1 While watching TV, press **BACK** ◀ or **NEXT** ▶ to open the Channel Browser™ and surf back to a previous item or surf forward to the next item in the list.
In **Browse** mode, when you stop on an item in the Channel Browser™, it will be highlighted and the TV will automatically tune to the channel or input.
- 2 Press **EXIT** to close the Channel Browser™.

To tune to a channel or input in Select mode:

- 1 While watching TV, press **BACK** ◀ or **NEXT** ▶ to open the Channel Browser™ and surf back to a previous item or forward to the next item in the list.
In **Select** mode, when you stop on an item in the Channel Browser™, it will be highlighted but you must press **ENTER** to tune the TV to the highlighted item.
- 2 Press **ENTER** to tune the TV to the highlighted item.
- 3 Press **EXIT** to close the Channel Browser™.

Adding and clearing channels and inputs in the History List

Adding channels and inputs to the History List:

As a channel or input is tuned, the Channel Browser™ adds it to the History List and displays it on the “right side” of the Channel Browser™. Previously tuned channels/inputs are “shifted” to the left, eventually moving off the left side. Press **BACK** ◀ to surf backward through the previously tuned channels/inputs. Any channel or input that is tuned repeatedly will not be repeated in the History List, but instead is moved to the end of the list on the right side of the Channel Browser™.

The Channel Browser™ will store the following channels:

- All channels that are tuned using the numeric buttons on the remote control.
- All channels that are tuned using **CH** or **CH** on the remote control.

Note: Whenever an item is selected that cannot be tuned (for various reasons), the TV will automatically tune to the previously viewed channel or input.

Clearing channels from the History List:

- Reconfiguring the **ANT** input will clear the History List.
Note: See page 44 for details on configuring the antenna input.
- Once 32 channels or inputs are stored in the History List, the oldest item will be removed from the list when a new channel or input is tuned.
- If **History List** in the **Channel Browser Setup** is set to “**Power Off Clear (On)**,” turning off the TV will clear the History List.

Tuning to the next programmed channel

To tune to the next programmed channel:

Press or on the remote control or TV control panel.

Note: This feature will not work unless you program channels into the TV's channel memory (page 44).

Tuning to a specific channel (programmed or unprogrammed)

Tuning analog channels:

Press the Channel Number (0–9) on the remote control. For example, to select channel 125, press 1, 2, 5.

Tuning digital channels:

Press the Channel Number (0–9) on the remote control, followed by the dash () button and then the sub-channel number. For example, to select digital channel 125-1, press 1, 2, 5, -, 1.

Note: If a digital channel is not programmed—either through the automatic channel scan (page 44) or the channel add/delete function (page 45)—you will have to tune the RF channel using the Channel Number and dash () on the remote control.

Switching between two channels using Channel Return

The Channel Return feature allows you to switch between two channels without entering an actual channel number each time.

- 1 Select the first channel you want to view.
- 2 Select a second channel using the Channel Number buttons (and the dash () button if selecting a digital channel).
- 3 Press on the remote control. The previous channel will display. Each time you press , the TV will switch back and forth between the last two channels that were tuned.

Note: If you press from a non-antenna input, the TV will return to the last-viewed input.

Switching between two channels using SurfLock™

The SurfLock™ feature temporarily “memorizes” one channel to the button, so you can return to that channel quickly from any other channel by pressing . To memorize a channel to the button:

- 1 Tune the TV to the channel you want to program into the button.
- 2 Press and hold for about 2 seconds until the message “Channel Memorized” appears on-screen. The channel has been programmed to the button.
- 3 You can then change channels repeatedly, and when you press , the memorized channel will be tuned.

The TV will return to the memorized channel one time only. Once you press and then change channels again, the CH RTN memory will be cleared and the button will function as Channel Return, by switching back and forth between the last two channels that are tuned. This feature also works for external inputs.

Selecting the picture size

You can view many program formats in a variety of picture sizes—**Natural**, **TheaterWide 1**, **TheaterWide 2**, **TheaterWide 3**, **Full**, **4:3 HD** and **Native**.

Note: The “picture size” illustrations are examples only. The format of the image (in any of the picture sizes) will vary depending on the format of the signal you are currently watching. Select the picture size that displays the current program the way that looks best to you.

You can save separate picture size preferences for each input on your TV.

To select the picture size using the remote control:

- 1 Press **PIC SIZE** on the remote control.
- 2 While the **Picture Size** screen is open, you can do one of the following to select the desired picture size:
 - Repeatedly press **PIC SIZE**.
 - Press the corresponding Number button (0–6) while the **Picture Size** screen is open.
 - Press **▲** or **▼** while the **Picture Size** screen is open.

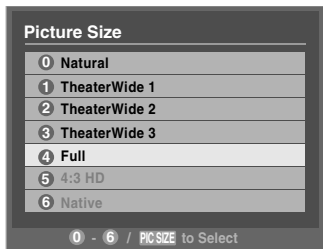

To select the picture size using the menus:

- 1 Select **Picture Size** in the **Theater Settings** menu.
- 2 Press **◀** or **▶** to select the desired picture size setting.
- 3 Highlight **Done** and press **ENTER**.



Note: Some of the picture sizes may not be available depending on the receiving signal format (those will be “grayed out” in the **Picture Size** screen).

Using these functions to change the picture size (i.e., changing the height/ width ratio) for any purpose other than your private viewing may be prohibited under the Copyright Laws of the United States and other countries, and may subject you to civil and criminal liability.

Note: If you select one of the TheaterWide® picture sizes, the top and bottom edges of the picture (including subtitles or captions) may be hidden. To view the hidden edges, either scroll the picture (**TheaterWide 2** and **3** only) or try viewing the program in **Full** or **Natural** picture size.

Natural picture size

- The image is displayed close to its originally formatted proportion. Some program formats will display with sidebars and/or bars at the top and bottom.

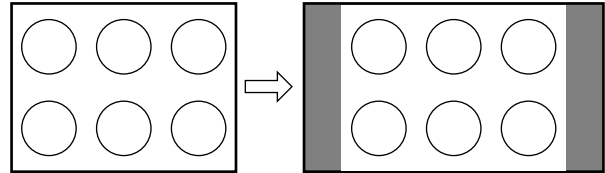

Natural picture size example

TheaterWide 1 picture size (for 4:3 format programs)

- The center of the picture remains close to its original proportion, but the left and right edges are stretched wider to fill the screen.

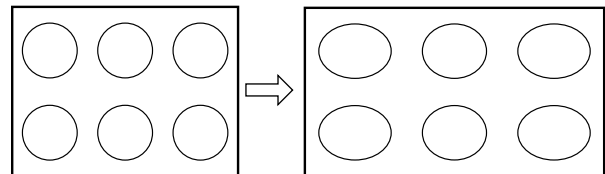

TheaterWide 1 picture size example

TheaterWide 2 picture size (for letter box programs)

- The picture is stretched wider to fill the width of the screen, but only slightly stretched taller.
- The top and bottom edges of the picture may be hidden. To view the hidden areas, see “Scrolling the TheaterWide® picture” (page 58).

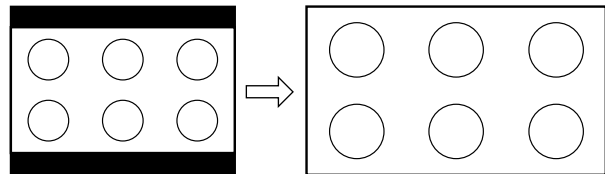

TheaterWide 2 picture size example

TheaterWide 3 picture size (for letter box programs with subtitles)

- The picture is stretched wider to fill the width of the screen, but only slightly stretched taller.
- The top and bottom edges are hidden. To view the hidden areas (such as subtitles or captions), see “Scrolling the TheaterWide® picture on the next page.”

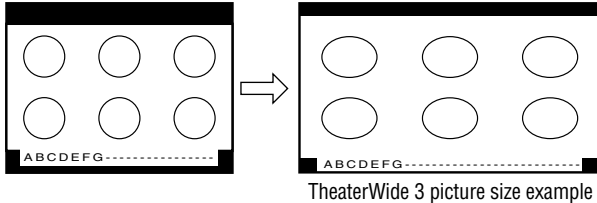

Full picture size (for 16:9 [480i, 480p] source programs only)

- If receiving a squeezed 4:3 format program, the picture is stretched wider to fill the width of the screen, but not stretched taller.
- None of the picture is hidden.

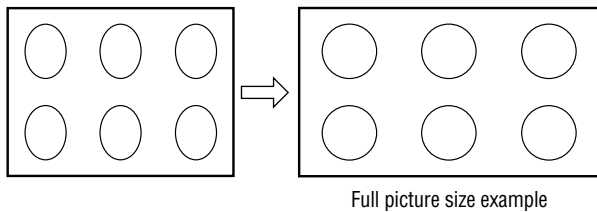

4:3 HD picture size (for 720p, 1080i, and 1080p program sources only)

- Sidebars fill the empty vertical spaces.
- Picture is not distorted from original size.

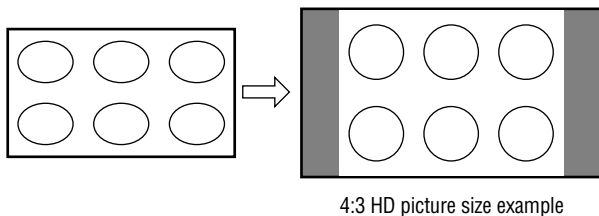

Native picture size (for 720p, 1080i, and 1080p signal programs)

- If receiving a 720p, 1080i, or 1080p signal program, Native mode scales the video to display the entire picture within the borders of the screen (i.e. no overscanning).
- This is especially useful for external HD sources such as HD-DVD, DVHS movies, or PC graphics.

Note:

- Native picture size is available for 720p, 1080i, and 1080p signals only. If the signal being received is other than 1080i, 1080p, or 720p, “Native” will be grayed out in the **Picture Size** screen.
- This mode is supported only for HDMI and ColorStream inputs.
- Depending on the input signals, the border of the picture may be hidden, displayed in black, or noisy.

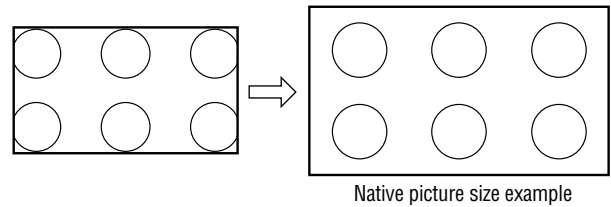

Scrolling the TheaterWide® picture (TheaterWide 2 and 3 only)

You can set separate scroll settings for the TheaterWide 2 and TheaterWide 3 modes for each input.

To set the scroll settings:

- 1 Press **MENU** and open the **Video** menu.
- 2 Highlight **Theater Settings** and press **ENTER**.

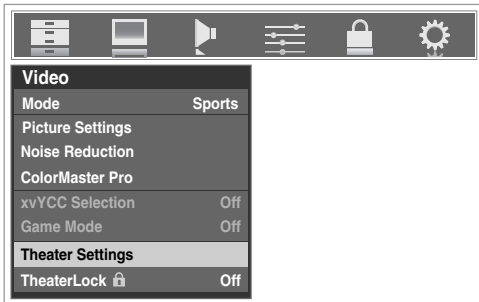

- 3 In the **Picture Size** field, select either **TheaterWide 2** or **TheaterWide 3** (you cannot scroll in any other mode).
- 4 Press **▼** to highlight the **Picture Scroll** field.
- 5 Press **◀** or **▶** to scroll the picture up and down as needed, from -10 to +20.



- 6 To save the new settings, highlight **Done** and press **ENTER**. To revert to the factory defaults, highlight **Reset** and press **ENTER**.

Using the auto aspect ratio feature

When the auto aspect ratio feature is set to **On**, the TV will automatically select the picture size when one of the following input sources is received:

- A 480i signal from the **VIDEO 1**, **VIDEO 2**, **ColorStream HD-1**, or **ColorStream HD-2** input.
- A 480i, 480p, 720p, 1080i, 1080p, or VGA signal from the **HDMI** input.

Aspect ratio of signal source	Automatic aspect size (automatically selected when Auto Aspect is On)
4:3 normal	Natural (with sidebars)
4:3 letter box	TheaterWide 2
16:9 full	Full
Not defined (no ID-1 data or HDMI aspect data)	The current picture size you set under "Selecting the picture size" on page 56.

Note: The auto aspect ratio feature is not applicable to antenna or cable input sources.

To turn on the auto aspect ratio feature:

- 1 Press **MENU** and open the **Video** menu.
- 2 Highlight **Theater Settings** and press **ENTER**.
- 3 In the **Auto Aspect Ratio** field, select **On**.



- 4 To save the new settings, highlight **Done** and press **ENTER**. To revert to the factory defaults, highlight **Reset** and press **ENTER**.

To turn off the auto aspect ratio feature:

Select **Off** in step 3 above.

Using the FREEZE feature

To use the FREEZE feature:

- 1 When viewing the TV, press **FREEZE** to make the picture a still picture.
- 2 To return to moving picture, press **FREEZE** again.

Note:

- If the TV is left in FREEZE mode for more than 15 minutes, the FREEZE mode will automatically be released and the TV will return to moving picture.
- The FREEZE feature is not available when the POP double-window is open. If you press **FREEZE**, the message "Not Available" will appear.

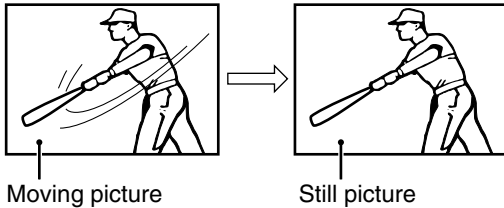

Using the FREEZE function for any purpose other than your private viewing may be prohibited under the Copyright Laws of the United States and other countries, and may subject you to civil and criminal liability.

Using the POP features

Using the POP double-window feature

The POP (picture-out-picture) double-window feature splits the screen into two windows so you can watch two programs at the same time.

To display a program in the POP window:

- 1 Press **POP** to open the POP double-window.

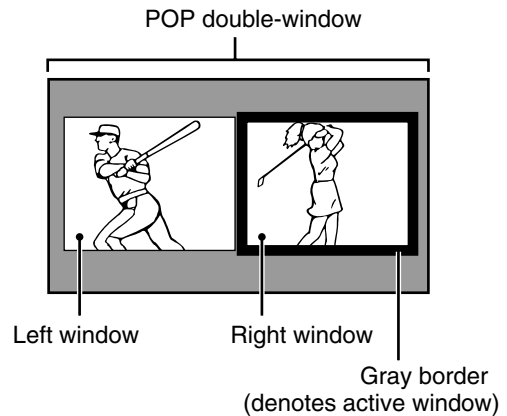

- 2 Press **◀** or **▶** to highlight the desired window. When highlighted, the window will have a gray border.
- 3 Press **INPUT** to open the **Input Selection** window. Select the input source for the POP window by pressing the corresponding Number button (0–8). The current source displays in yellow.

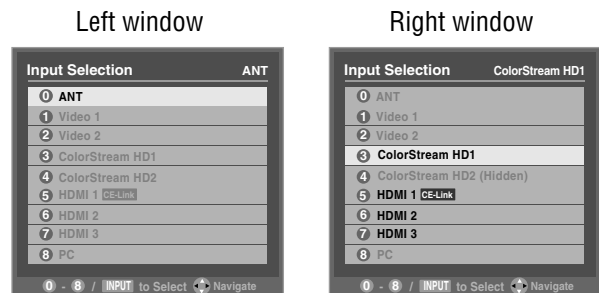

Left window — **ANT** input is selectable.

Right window — **ColorStream HD1** and **HD2** (only for 480p, 1080i, and 720p), and **HDMI 1**, **HDMI 2**, **HDMI 3** are selectable.

Note:

- The message "Current video format cannot be displayed" will appear if you press **POP** when the TV is in **ColorStream HD1** or **HD2** mode and is receiving a 480i format signal.
- The FREEZE feature is not available when the POP double-window is open. If you press **FREEZE** when the POP double-window is open, the message "Not Available" will appear.

(continued)

- If you labeled all of the inputs as HIDE (see page 52), the POP feature will be disabled and the message “Not Available” will appear if you try to open the POP double-window.
- The message “Not Available” will appear if you try to open the POP double-window when the Input Lock feature is in **Video** or **Video+** mode.

To tune to the highlighted window (and close the POP double-window):

Press **ENTER** after highlighting the window you want to view as a normal picture.

Selecting the POP window audio out

While the POP double-window is open, press **◀** or **▶** to select which audio (left or right POP window) to be output from the TV speakers (and also from the **VARIABLE AUDIO OUT** and **AUDIO OUT** terminals).

The window with the active audio is outlined with a gray border.

Example: Press **◀**

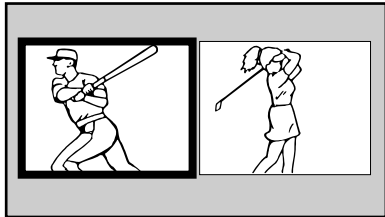

Example: Press **▶**

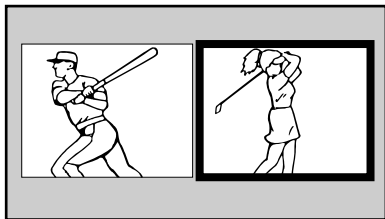

Adjusting the picture

Selecting the picture mode

You can select your desired picture settings from different modes, as described below.

Mode	Picture Quality
Sports	Bright and dynamic picture (factory setting)
Standard	Standard picture settings (factory setting)
Movie	Lower contrast for darkened room (factory setting)
Document	Designed for viewing of tables/documents from a PC (factory setting)
Preference	Your personal preferences
Pro 1	Custom settings based on Standard mode (factory settings)
Pro 2	Custom settings based on Movie mode (factory settings)

Note: Document mode is available for HDMI input sources only (grayed out for other input sources).

To select the picture mode:

- 1 Press **MENU** and open the **Video** menu.
- 2 Highlight **Mode** and press **ENTER**.

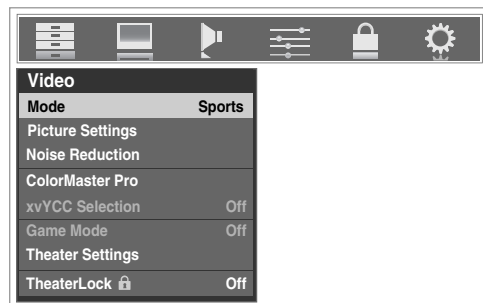

- 3 Press **▲** or **▼** to select the picture mode you prefer and press **ENTER**.



Note: The picture mode you select affects the current input only. You can select a different picture mode for each input.

Adjusting the picture quality

You can adjust the picture quality (Contrast, Back Light, DynaLight™, Brightness, Color, Tint, and Sharpness) to your personal preferences.

Selection	Pressing ◀	Pressing ▶
Contrast	lower	higher
Back Light*	darker	lighter
DynaLight**	On/Off	On/Off
Brightness	darker	lighter
Color	paler	deeper
Tint	reddish	greenish
Sharpness	softer	sharper

* Back Light
This feature adjusts the brightness of the entire screen. When in video mode and no signal is input, this will automatically be set to 0. (Settings are stored in memory.)

**DynaLight
This function automatically strengthens the black coloring of dark areas in the video according to the level of darkness.

To adjust the picture quality:

- 1 Press **MENU** and open the **Video** menu.
- 2 Highlight **Picture Settings** and press **ENTER**.
- 3 Press **▲** or **▼** to select the picture quality you want to adjust (**Contrast**, **Back Light**, **DynaLight**, **Brightness**, **Color**, **Tint**, or **Sharpness**), and then press **◀** or **▶** to adjust the setting, as described in the table above.

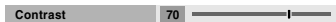
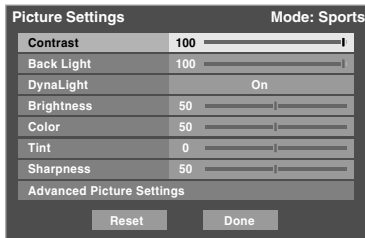

- 4 To save the new settings, highlight **Done** and press **ENTER**. You can use any of the picture modes (see “Selecting the picture mode,” on the previous page) as a starting point for adjusting the picture settings.
To revert back to the base mode that you began adjusting the picture settings from, highlight **Reset** and press **ENTER**.

Note:

- If you select a picture mode other than **Pro 1** or **Pro 2**, the picture qualities you adjusted are automatically saved in the **Preference** mode (see “Selecting the picture mode,” on the previous page).
- If you select picture mode **Pro 1** (or **Pro 2**) and then change a picture quality setting, those values are saved in picture mode **Pro 1** (or **Pro 2**).

Using the TheaterLock™ feature

The TheaterLock™ feature allows you to “lock” all items that affect the picture mode setting. In other words, those settings that when adjusted cause the Mode setting to automatically change to “Preference” will be grayed out and unavailable when the TheaterLock setting is set to “On”. Items that do not influence Mode status will not be affected e.g., Noise Reduction, xvYCC Selection, Game Mode, etc.

To turn on TheaterLock™:

- 1 Press **MENU** and open the **Video** menu.
- 2 Press **▲** or **▼** to highlight the **TheaterLock** field, and then press **◀** or **▶** to select **On**.

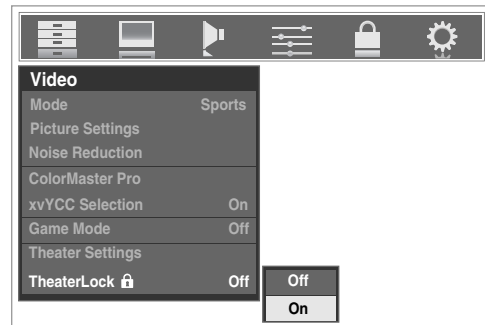

To turn off TheaterLock™:

Select **Off** in step 2 above.

Note: When TheaterLock is set to **On**, a lock icon (🔒) will also be displayed in all Video menu windows where items are disabled.



Using the closed caption mode

Base closed captions

The closed caption mode has two options:

- **Captions**—An on-screen display of the dialogue, narration, and sound effects of TV programs and videos that are closed captioned (usually marked “CC” in program guides).
- **Text**—An on-screen display of information not related to the current program, such as weather or stock data (when provided by individual stations).

To view captions or text:

- 1 Press **MENU** and open the **Preferences** menu.
- 2 Highlight **Base CC Mode** and press **▶**.
- 3 Press **▲** or **▼** to select the desired closed caption mode and press **ENTER**.

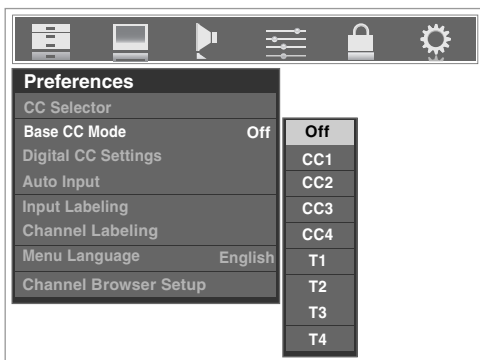

- **To view captions:**
Highlight **CC1**, **CC2**, **CC3**, or **CC4**. (**CC1** displays translation of the primary language in your area.)



Note: If the program or video you selected is not closed captioned, no captions will display on-screen.

- **To view text:**
Highlight **T1**, **T2**, **T3**, or **T4**.

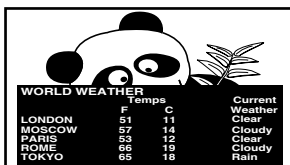

Note: If text is not available in your area, a black rectangle may appear on screen. If this happens, set the Base CC Mode to **Off**.

- **To turn off the closed caption mode:**
Select **Off** in step 3 above.

Note: A closed caption signal may not display in the following situations:

- When a videotape has been dubbed
- When the signal reception is weak
- When the signal reception is non-standard

Digital CC Settings

You can customize the closed caption display characteristics by changing the background color, text size, opacity, type, edge, and color.

Note:

- This feature is available for digital channels only.
- You cannot set the Caption Text and Background as the same color.

To customize the closed captions:

- 1 Press **MENU** and open the **Preferences** menu.
- 2 Highlight **Digital CC Settings** and press **ENTER**.
- 3 Press **▲** or **▼** to highlight the characteristic you want to change, and then press **◀** or **▶** to select the format for that characteristic (see table below).

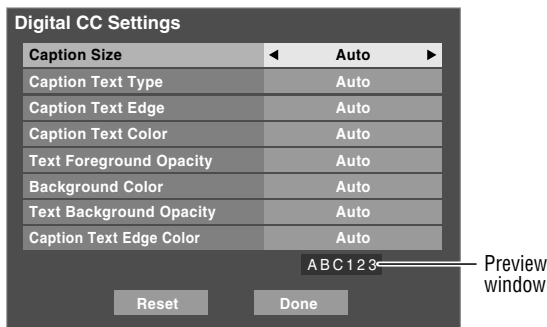

- 4 To save the new settings, highlight **Done** and press **ENTER**. To revert to the factory defaults, highlight **Reset** and press **ENTER**.

Caption Size	Auto, Small, Standard, Large
Caption Text Type	Auto, Default, Mono w. Serif, Prop. w. Serif, Mono w/o Serif, Prop. w/o Serif, Casual, Cursive, Small Capitals
Caption Text Edge	Auto, None, Raised, Depressed, Uniform, Left Drop Shadow, Right Drop shadow
Caption Text Color	Auto, Black, White, Red, Green, Blue, Yellow, Magenta, Cyan
Text Foreground Opacity	Auto, Transparent, Translucent, Flashing, Solid
Background Color	Auto, Black, White, Red, Green, Blue, Yellow, Magenta, Cyan
Text Background Opacity	Auto, Transparent, Translucent, Flashing, Solid
Caption Text Edge Color	Auto, Black, White, Red, Green, Blue, Yellow, Magenta, Cyan

CC Selector

You can use the **CC Selector** to temporarily override the default analog caption mode (set in **Base CC Mode**) for a particular channel. However, once you change to another analog channel, the closed caption setting will automatically change back to the current **Base CC Mode** setting.

You can also use the **CC Selector** to select digital closed caption services (if available). When such services are not available, the **CC Selector** presents a default list of services. If the selected service is not available, the next best service will be used instead.

To select closed captions:

- 1 Press **MENU** and open the **Preferences** menu.
- 2 Highlight **CC Selector** and press **ENTER**.

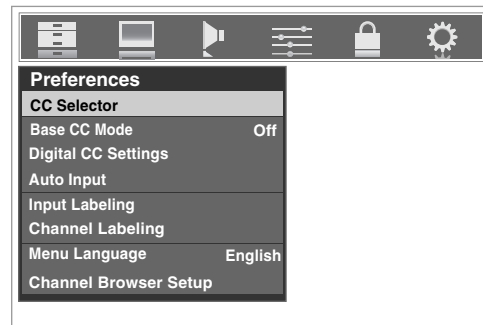

- 3 Press **▲** or **▼** to select **Closed Caption**, and then press **◀** or **▶** to select the desired service.



- 4 Press **EXIT**.

Using the Closed Caption button on the remote control

If you press **CCAPTION when an analog channel is tuned:**

- The CC selector will be active and will display CC1-4 and T1-4 as the options.
- The audio selector will be disabled.

If you press **CCAPTION when a digital channel is tuned:**

- The CC selector will be active and will display the possible caption options (available languages) for that channel or service. For example, in addition to English, a channel might offer closed captions in Spanish and/or French.
- The audio selector will be active and will offer different audio choices for the digital channel (Dolby or AC3, for example).

Adjusting the audio

Muting the sound

Press **MUTE** to partially reduce (1/2 MUTE) or turn off (MUTE) the sound. Each time you press **MUTE**, the mute mode will change in the following order:

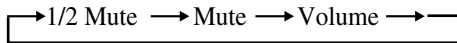

If the closed caption mode is set to **Off** when you select “MUTE” mode, the closed caption feature is automatically activated. To mute the audio without automatically activating the closed caption feature, use **VOLUME** to set the volume to 0. See “Using the closed caption mode” (page 62) for more information on closed caption modes.

Using the digital audio selector

You can use the **Digital Audio Selector** to conveniently switch between audio tracks on a digital channel (for those channels that have multiple audio tracks). This temporarily overrides the audio track chosen by the language option under **Audio Setup** (see “Selecting stereo/SAP broadcasts” at right).

To use the digital audio selector:

- 1 Press **MENU** and open the **Audio** menu.
- 2 Highlight **Digital Audio Selector** and press **ENTER**.

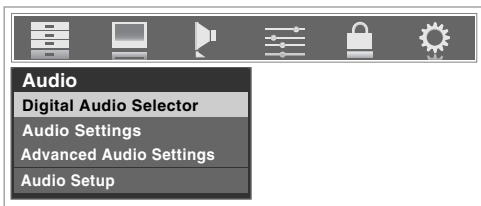

- 3 Press **▲** or **▼** to select **Audio**, and then press **◀** or **▶** to select the desired service.



- 4 Press **EXIT**.

Selecting stereo/SAP broadcasts

The multi-channel TV sound (MTS) feature allows you to output high-fidelity stereo sound. MTS can also transmit a second audio program (SAP) containing a second language, music, or other audio information (when provided by individual stations).

When the TV receives a stereo or SAP broadcast, the word “STEREO” or “SAP” appears on-screen when **RECALL** is pressed. The MTS feature is not available when the TV is in VIDEO mode.

To listen to stereo sound:

- 1 Press **MENU** and open the **Audio** menu.
- 2 Highlight **Audio Setup** and press **ENTER**.

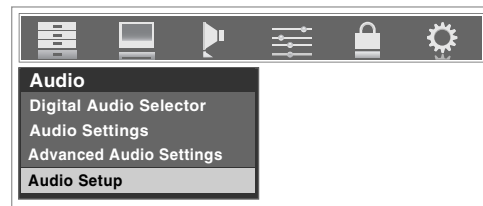

- 3 In the **MTS** field, select **Stereo**.

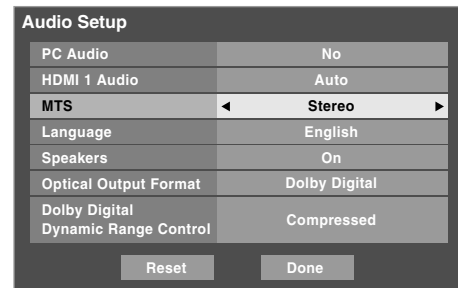

- 4 To save the new settings, highlight **Done** and press **ENTER**. To reset the settings to the factory defaults, highlight **Reset** and press **ENTER**.

Note:

- You can typically leave the TV in **Stereo** mode because it will automatically output the type of sound being broadcast (stereo or monaural).
- If the stereo sound is noisy, select **Mono** to reduce the noise.

To listen to an alternate language on an ATSC digital station (if available):

Highlight the **Language** field in step 3 above, and then press **◀** or **▶** to select the language you prefer.

To listen to a second audio program on an analog station (if available):

Select **SAP** in step 3 on the previous page.

Note:

- A second audio program (SAP) can be heard only on those TV stations that offer it. For example, a station might broadcast another language as a second audio program. If you have SAP on, you will see the current program on the screen but hear the other language instead of the program's normal audio.
- If you have SAP on and the station you are watching is not broadcasting a second audio program, the station's normal audio will be output. However, occasionally there is no sound at all in **SAP** mode. If this happens, set the **MTS** feature to **Stereo** mode.

Adjusting the audio quality

You can adjust the audio quality by adjusting the bass, treble, and balance.

To adjust the audio quality:

- 1 Press **MENU** and open the **Audio** menu.
- 2 Highlight **Audio Settings** and press **ENTER**.
- 3 Press **▼** or **▲** to highlight the item you want to adjust (**Bass**, **Treble**, or **Balance**).

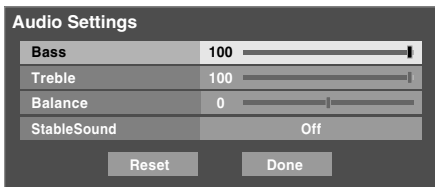

- 4 Press **◀** or **▶** to adjust the level.
 - **◀** makes the bass or treble weaker or increases the balance in the left channel (depending on the item selected).
 - **▶** makes the bass or treble stronger or increases the balance in the right channel (depending on the item selected).
- 5 To save the new settings, highlight **Done** and press **ENTER**. To reset the settings to the factory defaults, highlight **Reset** and press **ENTER**.

Using the StableSound® feature

The StableSound® feature limits the highest volume level to prevent extreme changes in volume when the signal source changes (for example, to prevent the sudden increase in volume that often happens when a TV program switches to a commercial).

To turn on the StableSound® feature:

- 1 Press **MENU** and open the **Audio** menu.
- 2 Highlight **Audio Settings** and press **ENTER**.
- 3 In the **StableSound** field, select **On**.

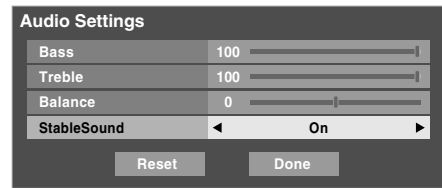

- 4 To save the new settings, highlight **Done** and press **ENTER**. To revert to the factory defaults, highlight **Reset** and press **ENTER**.

Note: The **RESET** function returns your audio adjustments to the following factory settings:

- Bass center (50)
- Treble center (50)
- Balance center (0)
- StableSound . . Off

To turn off the StableSound feature:

Select **Off** in step 3 above.

Turning off the built-in speakers

You can use this feature to turn off the TV speakers when you connect an audio system to your TV (see “Connecting a digital audio system” and “Connecting an audio system” on page 22).

To turn off the built-in speakers:

- 1 Press **MENU** and open the **Audio** menu.
- 2 Highlight **Audio Setup** and press **ENTER**.
- 3 In the **Speakers** field, select **Off**.

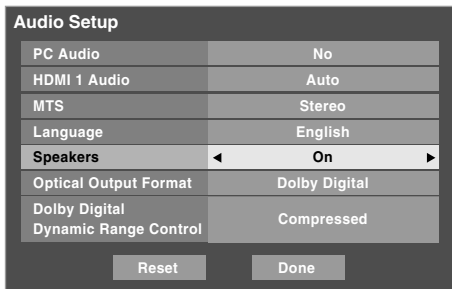

- 4 To save the new settings, highlight **Done** and press **ENTER**. To revert to the factory defaults, highlight **Reset** and press **ENTER**.

To turn on the built-in speakers:

Select **On** in step 3 above.

Selecting the optical audio output format

You can use this feature to select the optical audio output format when you connect a Dolby Digital decoder or other digital audio system to the **Optical Audio Out** terminal on the TV (see “Connecting a digital audio system” on page 22).

To select the optical audio output format:

- 1 Press **MENU** and open the **Audio** menu.
- 2 Highlight **Audio Setup** and press **ENTER**.
- 3 In the **Optical Output Format** field, select either **Dolby Digital** or **PCM**, depending on your device.

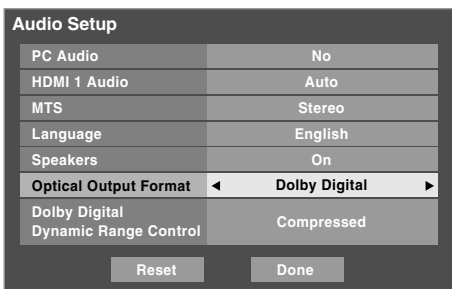

- 4 To save the new settings, highlight **Done** and press **ENTER**. To revert to the factory defaults, highlight **Reset** and press **ENTER**.

Using the Dolby® Digital Dynamic Range Control feature

This dynamic range control feature causes the ATSC dynamic range to be further compressed, allowing you to switch from ATSC to analog broadcasts at the same dynamic range.

To use the Dolby Digital Dynamic Range Control:

- 1 Press **MENU** and open the **Audio** menu.
- 2 Highlight **Audio Setup** and press **ENTER**.
- 3 In the **Dolby Digital Dynamic Range Control** field, select **Compressed**. When **Standard** is selected, the audio is output with minimal compression.

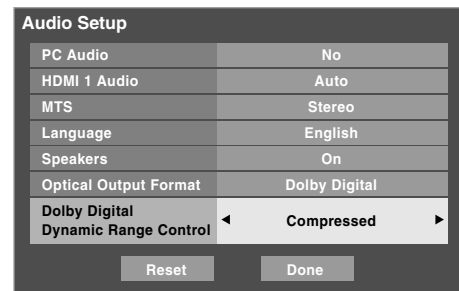

- 4 To save the new settings, highlight **Done** and press **ENTER**. To revert to the factory defaults, highlight **Reset** and press **ENTER**.

Note:

- This item will be grayed out for NTSC signals, Video, ColorStream, and PC inputs.
- The Dolby Digital Dynamic Range Control will function in relation to Optical Output Format (PCM mode).

Using the Locks menu

The Locks menu includes the Enable Rating Blocking, Edit Rating Limits, Channels Block, Input Lock, Front (control) Panel Lock, Game Timer, and New PIN Code features. You can use these features after entering the correct PIN code.

Entering the PIN code

- 1 Press **MENU** and highlight the **Locks** menu icon.

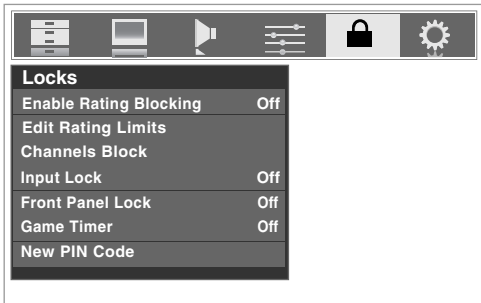

- 2 Press **▼**, which displays the PIN code entry screen.
 - The **Lock System** screen (below) appears if a PIN code has not been stored. Press the Channel Number buttons to enter a new four-digit code, enter the code a second time to confirm, and press **ENTER**.

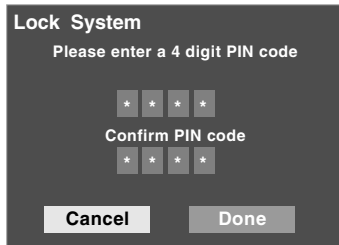

- The **Locks/Active** screen (below) appears if the PIN code is already stored. Use the Number buttons to enter your four-digit code and press **ENTER**.

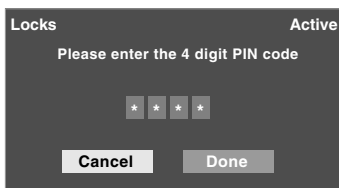

If the wrong PIN code is entered, the message "Incorrect PIN code, please try again!" appears. Highlight **Retry** and press **ENTER**. Enter the code again and press **ENTER**.

When the correct PIN code is entered, the **Locks** menu opens.

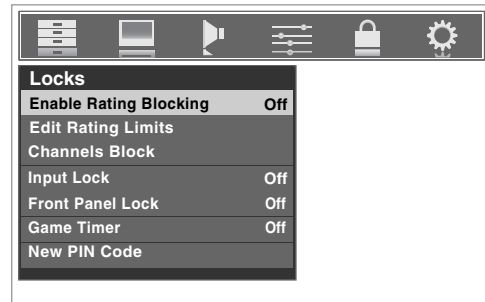

If you cannot remember your PIN code

While the PIN code entering screen is displayed, press **RECALL** four times within five seconds. The PIN code will be cleared and you can enter a new PIN code.

Changing your PIN code

- 1 Press **MENU** and highlight the **Locks** menu icon.
- 2 Press **▼** to display the PIN code entering screen.
- 3 Enter your four-digit PIN code and press **ENTER**.
- 4 Press **▼** to highlight **New PIN Code** and press **ENTER**.

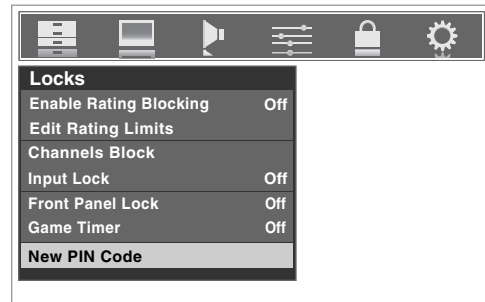

- 5 Press the Number buttons to enter a new four-digit code. Reenter the PIN code to confirm it.
- 6 Press **ENTER**. The new PIN code is now active.



Blocking TV programs and movies by rating (V-Chip)

Some TV programs and movies include signals that classify the content of the program (violence, sex, dialog, language). The V-Chip feature in this TV detects the signals and blocks the programs according to the ratings you select. (For rating descriptions, see the tables on the next page.)

Note: Rating blocking is a function of the V-Chip feature in this TV, which supports the U.S. V-Chip system only.

To block and unblock TV programs and movies:

- 1 Press **MENU** and highlight the **Locks** menu icon.
- 2 Press **▼** to display the PIN code entering screen.
- 3 Enter your four-digit PIN code and press **ENTER**.
- 4 Press **▼** to highlight **Enable Rating Blocking**.
- 5 Press **▶** and **▼** to select **On**, and then press **ENTER**.

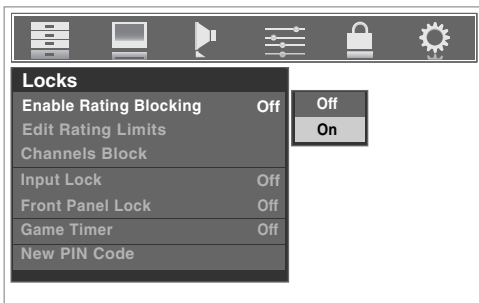

- 6 Press **▼** to highlight **Edit Rating Limits** and press **ENTER**. The **Edit Rating Limits** screen (below) appears.
- 7 Press **▲▼◀▶** and then press **ENTER** to select the level of blocking you prefer. A box with an "X" is a rating that will be blocked. As you highlight a rating, a definition for the rating appears at the bottom of the screen.
- 8 When done selecting the ratings you want to block, highlight **Done** and press **ENTER**.



Downloading an additional rating system for blocking TV programs and movies

In the future, an additional rating system may become available for use in selectively blocking programs.

Note: The currently tuned station must be receiving a digital signal before an additional rating system can be downloaded.

To download the additional rating system (if available):

- 1 Press **MENU** and highlight the **Locks** menu icon.
- 2 Press **▼** to display the PIN code entering screen.
- 3 Enter your four-digit PIN code and press **ENTER**.
- 4 Press **▼** to highlight **Enable Rating Blocking**.
- 5 Press **▶** and **▼** to select **On**, and press **ENTER**.
- 6 Press **▼** to highlight **Edit Rating Limits** and press **ENTER**. The **Edit Rating Limits** screen appears.
- 7 Highlight **Alt RS** and press **ENTER**. The **Edit Alternate Ratings** screen will appear.

Note:

- The **Alt RS** button will only be available if an additional rating system is currently available.
- It may take several minutes for the TV to download the additional rating system.
- The information displayed in the **Alternate Ratings** screen will depend on the configuration of the additional rating system available at the time of download.

- 8 Press **▲▼◀▶** and then press **ENTER** to select the level of blocking you prefer. A box with an "X" is a rating that will be blocked.
- 9 When you are finished selecting the ratings you want to block, highlight **Done** and press **ENTER**.
- 10 In the **Edit Rating Limits** screen, highlight **Done** and press **ENTER**.

Note:

- The additional rating system can only be downloaded one time. You will not be able to download any updates to the rating system should such updates become available.
- The additional rating system is not designed, transmitted, or controlled by the TV or Toshiba, nor is the availability of an additional rating system determined or controlled by Toshiba. Similarly, the rating of programs in an additional rating system is not determined, transmitted, or controlled by the TV or Toshiba.
- The additional rating system is an evolving technology; therefore, availability, content, and format may vary.

Independent rating system for broadcasters	
Ratings	Description and Content themes
TV-MA	Mature Audience Only (This program is specifically designed to be viewed by adults and therefore may be unsuitable for children under 17.) L) Crude or indecent language S) Explicit sexual activity V) Graphic violence
TV-14	Parents Strongly Cautioned (This program contains some material that many parents would find unsuitable for children under 14 years of age.) D) Intensely suggestive dialog L) Strong, coarse language S) Intense sexual situations V) Intense violence
TV-PG	Parental Guidance Suggested (This program contains material parents may find unsuitable for younger children.) D) Some suggestive dialog L) Infrequent coarse language S) Some sexual situations V) Moderate violence
TV-G	General Audience (Most parents would find this program suitable for all ages.)
TV-Y7, TV-Y7FV	Directed to Older Children (This program is designed for children age 7 and above. Note: Programs in which fantasy violence may be more intense or more combative than other programs in this category are designated TV-Y7FV.)
TV-Y	All Children (This program is designed to be appropriate for all children.)

Independent rating system for movies	
Ratings	Description and Content themes
X	X-rated (For adults only)
NC-17	Not intended for anyone 17 and under
R	Restricted (Under 17 requires accompanying parent or adult)
PG-13	Parents Strongly Cautioned (Some material may be inappropriate for children under 13)
PG	Parental Guidance Suggested (Some material may not be suitable for children)
G	General Audience (Appropriate for all ages)

Note:

- If you place an "X" in the box next to "None Rated," programs rated "None" will be blocked; however, programs that do not provide any rating information will not be blocked.
- To display the rating of the program you are watching, press **RECALL** on the remote control. If it is rated "None," the word "NONE" appears in the **RECALL** screen (as shown below right). If rating information is not provided, no rating will appear in the **RECALL** screen.



Blocking channels

With the Channels Block feature, you can block specific channels. You will not be able to tune blocked channels unless you unlock them.

To block channels:

- 1 Press **MENU** and highlight the **Locks** menu icon.
- 2 Press **▼** to display the PIN code entering screen.
- 3 Enter your four-digit PIN code and press **ENTER** (page 67).
- 4 Press **▼** to highlight **Channels Block** and then press **ENTER**.

A list of the channels available for that input will be displayed along with the call letters for each channel, if available.

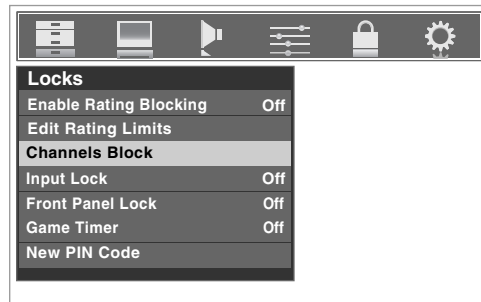

- 5 Press **▲▼** to highlight the channel you want to block and press **ENTER**, which puts an "X" in the box next to that channel.

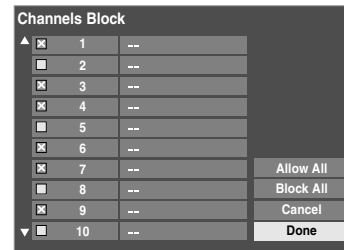

- 6 Repeat step 5 for other channels you want to block.
- 7 Highlight **Done** and press **ENTER**.

To unblock individual channels:

In step 5 above, press **▲▼** to highlight the channel you want to unblock, press **ENTER** to remove the "X" from the box, highlight **Done** and press **ENTER**.

(continued)

To block all channels at once:

Highlight **Block All** in step 5 on previous page and then highlight **Done** and press **ENTER**.

To unblock all locked channels at once:

Highlight **Allow All** in step 5 on previous page and then highlight **Done** and press **ENTER**.

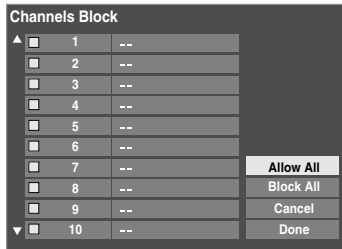

Unlocking programs temporarily

If you try to tune the TV to a program that exceeds the rating limits you set, the TV will enter program lock mode and the following message will appear on-screen:

This program exceeds the rating limit you set.
Push 'MUTE' to enter PIN.

You can either temporarily unlock the program or select an unlocked program to watch.

To temporarily unlock the program:

- 1 Press **MUTE**.
- 2 Enter your four-digit PIN code and press **ENTER**. If the correct code is entered, the program lock mode is released and the normal picture appears. All locking is disabled until the TV is turned off, and will be enabled when the TV is turned on again.



Using the input lock feature

You can use the Input Lock feature to lock the video inputs (**VIDEO 1, VIDEO 2, ColorStream HD-1, ColorStream HD-2, HDMI 1, HDMI 2, HDMI 3** and **PC**) and channels 3 and 4. You will not be able to view the input sources or channels until you unlock the inputs.

To lock/unlock the video inputs:

- 1 Press **MENU** and highlight the **Locks** menu icon.
 - 2 Press **▼** to display the PIN code entering screen.
 - 3 Enter your four-digit PIN code and press **ENTER**.
 - 4 Press **▼** to highlight **Input Lock** and press **▶**.
 - 5 Press **▲** or **▼** to select the level of video input locking you prefer, as described below.
 - Video:** Locks VIDEO 1, VIDEO 2, ColorStream HD1/HD2, HDMI 1, HDMI 2, HDMI 3, and PC.
 - Video+:** Locks VIDEO 1, VIDEO 2, ColorStream HD1/HD2, HDMI 1, HDMI 2, HDMI 3, PC and channels 3 and 4.
- Select **Video+** if you play video tapes via an ANT input.

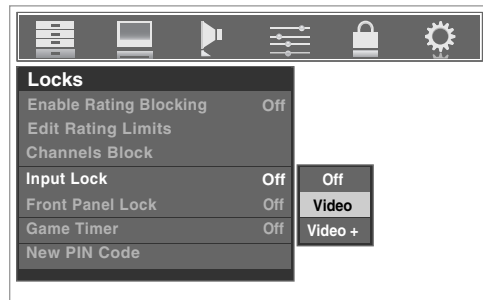

Off: Unlocks all video inputs and channels 3 and 4.

- 6 Press **ENTER**.

Using the GameTimer®

You can use the GameTimer to set a time limit for playing a video game (30–120 minutes). When the GameTimer expires, the TV enters Input Lock mode and locks out the input source for the video game device.

To set the GameTimer®:

- 1 Press **MENU** and highlight the **Locks** menu icon.
- 2 Press **▼** to display the PIN code entering screen.
- 3 Enter your four-digit PIN code and press **ENTER**.
- 4 Press **▼** to highlight **Game Timer** and press **▶**.
- 5 Press **▲** or **▼** to select the length of time until the Input Lock is activated (30, 60, 90, or 120 minutes) and press **ENTER**.

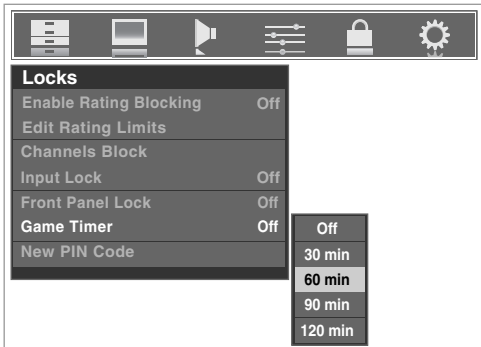

To cancel the GameTimer®:

Select **Off** in step 5 above.

To deactivate the Input Lock once the GameTimer has activated it:

Set the **Input Lock** to **Off** (☞ “Using the input lock feature” on the previous page).

Note:

- A message will appear when 10 minutes, 3 minutes, and 1 minute remain on the GameTimer.
- If the TV loses power with time remaining on the GameTimer, when power is restored the TV will enter Input Lock mode (as if the GameTimer had been activated) and you will have to deactivate the Input Lock (as described above).

Using the control panel lock feature

You can lock the control panel to prevent your settings from being changed accidentally (by children, for example). When the control panel lock is **On**, none of the controls on the TV control panel will operate except **POWER**.

To lock the control panel:

- 1 Press **MENU** and highlight the **Locks** menu icon.
- 2 Press **▼** to display the PIN code entering screen.
- 3 Enter your four-digit PIN code and press **ENTER**.
- 4 Press **▼** to highlight **Front Panel Lock**.
- 5 Press **▶** and **◀** or **▶** to highlight **On** and press **ENTER**. When the control panel is locked and any button on the control panel (except **POWER**) is pressed, the message “Not Available” appears.

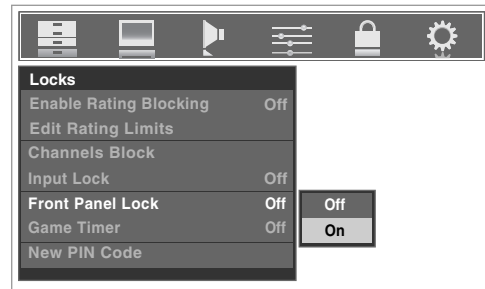

To unlock the control panel:

Highlight **Off** in step 5 above, or press and hold the **VOLUME** **◀** button on the TV control panel for about 10 seconds until the volume bar appears.

Using the PC settings feature

You can view an image from a PC on the TV screen.

When a PC is connected to the TV's PC IN terminal, you can use the PC Settings feature to make adjustments to the image.

If the edges of the picture are cut off, readjust the **Horizontal Position** and **Vertical Position**. If the picture is affected by interference, readjust the **Clock Phase** and **Sampling Clock**.

To adjust the PC settings:

- 1 Repeatedly press **INPUT** to select PC input mode (see "Selecting the video input source to view" page 51).
- 2 Press **MENU** and open the **Setup** menu.
- 3 Highlight **PC Settings** and press **ENTER**.

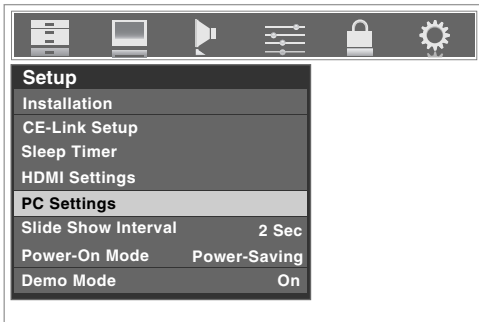

Note: If a PC is not connected or there is no pc input signal, this feature will be grayed out in the **Setup** menu.

- 4 Press **▲** or **▼** to highlight the item you want to adjust.
- 5 Press **◀** or **▶** to make the appropriate adjustments.

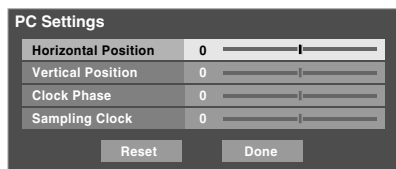

Note: The screen is disrupted momentarily when adjusting the PC settings. This is not a sign of malfunction.

- **Horizontal Position:**
Moves the picture left/right.
The adjustment range is within ± 10 from center.*
- **Vertical Position:**
Moves the picture up/down.
The adjustment range is within ± 10 from center.*
- **Clock Phase:**
Helps to reduce noise and sharpen the picture.
The adjustment range is within ± 2 from center.*
- **Sampling Clock:**
Helps to reduce noise and minimize periodic vertical stripes on the screen.
The adjustment range is within ± 5 from center.*

* The default settings may vary depending on the input signal format.

Setting the PC Audio

This function allows you to output the sound from your PC (if connected) or mute the sound from your PC and output the sound from your HDMI (DVI) connection. (see page 23)

To set the PC Audio:

- 1 Press **MENU** and open the **Audio** menu.
- 2 Highlight **Audio Setup** and press **ENTER**.
- 3 Press **▲** or **▼** to select **PC Audio** and then press **◀** or **▶** to select **No** or **Yes**.

Yes: Outputs the sound from your PC.

No: Mutes the sound from your PC, and outputs the sound from the HDMI-1 connection.

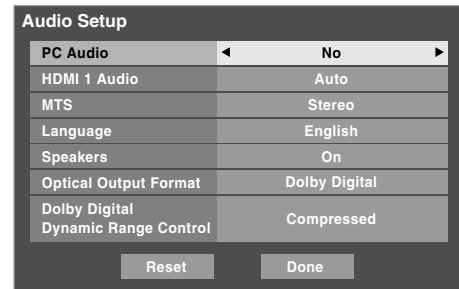

Note: Because the PC and HDMI-1 inputs share the same set of analog audio inputs, the **PC Audio** menu setting influences the **HDMI 1 Audio** menu setting. If **PC Audio** is set to "No," the **HDMI 1 Audio** setting changes to "Auto." If **PC Audio** is set to "Yes," the **HDMI 1 Audio** setting is set to "Digital" and is grayed out in the menu. (Also see item 5 on page 12 and "Setting the HDMI™ Audio mode" on page 48.)

Setting the sleep timer

You can set the sleep timer to turn off the TV after a set length of time (maximum of 180 minutes).

To set the sleep timer using the remote control:

Press **SLEEP** on the remote control to set the length of time until the TV turns off. Repeatedly press **SLEEP** to increase the time in 10-minute increments, or press **▲** or **▼** to increase or decrease the time in 10-minute increments, to a maximum of 180 minutes.

To set the sleep timer using the on-screen menus:

- 1 Press **MENU** and open the **Setup** menu.
- 2 Highlight **Sleep Timer** and press **ENTER**.

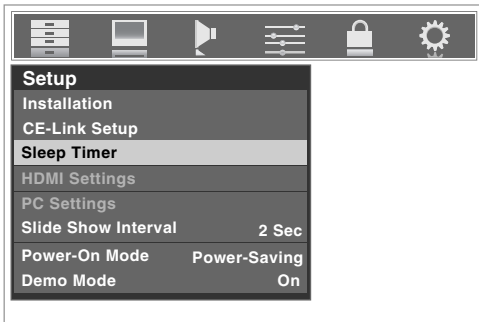

- 3 Press the Number buttons to enter the length of time in 10-minute increments.

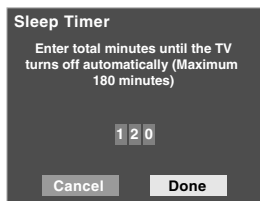

- 4 Highlight **Done** and press **ENTER**.

Note: When a power failure occurs, the sleep timer setting may be cleared.

To display the remaining sleep time:

Press **SLEEP**.

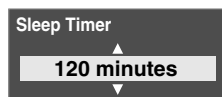

Note: A message will display on-screen when there is one minute remaining on the sleep timer.

To cancel the sleep timer:

Repeatedly press **SLEEP** until it is set to 0 minutes.

Using CE-Link

This is a new feature that uses CEC technology and allows you to control Toshiba CE-Link compatible devices from the TV remote via HDMI connection (see page 21).

When the Enable CE-Link item in the CE-Link setup menu (see page 74) is set to **On**, individual CE-Link functions also set to On will be activated.

CE-Link playback device (HD DVD player, etc.) control

With your TV's remote control, or using the CE-Link Control menu, you can control the connected CE-Link playback device you are watching.

Available remote control key functions:

Before using the following key functions, first select the TV mode by pressing the **TV** mode select button until the keypad blinks 3 times.

- **PLAY** begins playback.
- **STOP** stops playback.
- **PAUSE/STEP** pauses the picture during play or record mode.
- **SKIP** skips forward.
- **SKIP** skips backward.
- **FF** fast-forwards.
- **REW** rewinds/reverses.
- **▲ ▼ ◀ ▶** navigate the Contents Menu, etc.
- **ENTER** enters the Contents Menu, etc.
- **EXIT** returns to the previous menu.

Note: These functions depend on the device connected.

(continued)

CE-Link Player Control menu functions:

- 1 Press **THING** and open the **THINC Applications** menu.
- 2 Press **▲** or **▼** to highlight **CE-Link Player Control** and press **ENTER**.

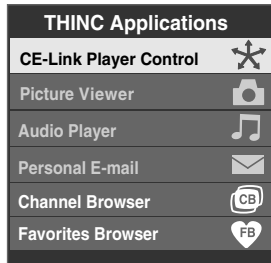

- 3 Press **▲** or **▼** to select the item you want to control and press **ENTER**.



- **POWER** turns the selected device on and off.
- **Top Menu** accesses the top menu of a DVD.
- **Menu** accesses the menu of a DVD.
- **Contents Menu** accesses the contents list when you press **ENTER**. At this time, the **CE-Link Player Control** menu will disappear.

Note:

- These functions depend on the devices that are connected.
- The **CE-Link Player Control** item will be grayed out in the following conditions:
 - A non-HDMI input is currently selected.
 - The **Enable CE-Link** item is set to **Off**.
 - The connected device is not a playback or recording device.

CE-Link input source selection

If a CE-Link device with HDMI switching capability (e.g. Audio Receiver) is connected to the HDMI input, you can select another CE-Link device that is connected to the master HDMI device using the TV's INPUT button. See page 51 for details.

Audio Receiver VOLUME and MUTE control

With your TV's remote control, you can adjust or mute the sound volume of the speakers connected to the TV via an audio receiver. First, select **TV** mode by pressing the TV button under MODE SELECT on the remote control.

- **VOLUME** adjust the volume level.
- **MUTE** turns off the sound.

Note:

- To use this function:
 - Set **Speaker Preference** to **Audio Receiver** in the **CE-Link Setup** menu.
 - Confirm that a connected CE-Link device (such as HD DVD player, etc) is selected for the Audio Receiver input source.
- You can also use this function when the audio receiver is connected to the TV's **DIGITAL AUDIO OUT** terminal (not HDMI connection). In this case, select a digital audio input mode on the Audio Receiver.
- These functions depend on the device connected.

Other CE-Link functions

When the **Enable CE-Link** is set to **On**, the following functions can be enabled by setting them to **On**.

- **TV Auto Input Switch**
If a connected HDMI device starts playing video or audio, the TV will automatically switch to the appropriate HDMI input.
- **TV Auto Power**
If a CE-Link device is turned on or off, the TV turns on or off automatically.
- **Device Auto Standby**
If the TV is turned off, the TV will send a message to turn off all of the CE-Link devices connected to the TV.
- **Speaker Preference**
From this item, you can set your audio output preference to the TV speakers or the audio receiver speakers. When this item is set to Audio Receiver, the TV remote can be used to adjust or mute the volume of the audio. This item will be grayed out unless a CE-Link compatible audio receiver is connected.

Note: When you turn on the Audio Receiver, change its input source, or adjust the sound volume, the sound will be output from the audio receiver's speakers even if **TV Speakers** has been selected. Turn the TV off and on again to output the sound from the TV Speakers.

To set the CE-Link Setup:

- 1 Press **MENU** and open the **Setup** menu.
- 2 Highlight **CE-Link Setup** and press **ENTER**.

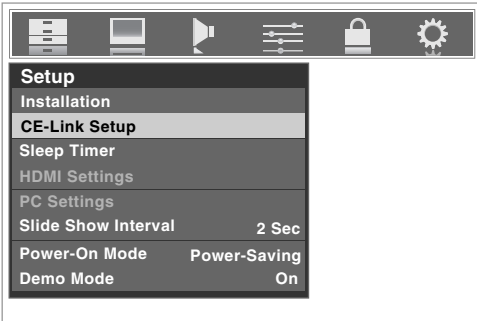

- 3 Press **▲** or **▼** to highlight **Enable CE-Link**.

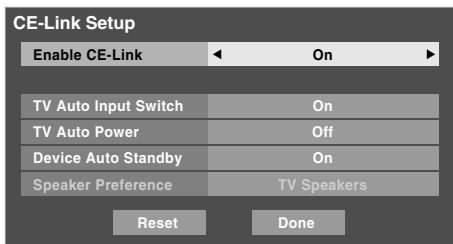

- 4 Press **◀** or **▶** to select **On**.

Note: If you set **Enable CE-Link** to **Off**, the all other items will be grayed out.

- 5 Press **▲** or **▼** to highlight the **CE-Link** setup item you want to use, and press **◀** or **▶** to select **On/Off** or the desired speakers mode.
 - TV Auto Input Switch: On/Off
 - TV Auto Power: On/Off
 - Device Auto Standby: On/Off
 - Speaker Preference: TV Speakers/Audio Receiver (See details on the previous page.)

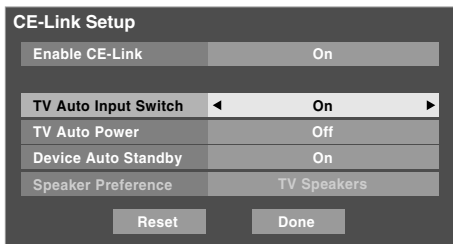

- 6 To save the new settings, highlight **Done** and press **ENTER**. To revert to the factory defaults, highlight **Reset** and press **ENTER**.

Using the HDMI settings feature

This menu consists of the following 3 items (new HDMI capabilities) and will be grayed out on non-HDMI inputs. Some HDMI legacy sources may not work properly with your HDMI TV, please try setting the following three options (Lip-Sync Latency, Deep Color, and xvYCC) to **Off**. Adjusting these settings should allow your HDMI legacy source to operate properly with your TV.

- **Lip-Sync Latency: On**
This option activates an auto audio/video display timing adjustment function that allows HDMI source devices to accurately perform synchronization automatically.
- **Deep Color: On**
This feature allows to HDMI source to increase available colors bits within the boundaries defined by the RGB or YCbCr color space.
- **xvYCC: On**
This feature expands the acceptable color range (limits) in the HDMI signals, then allows sending wider color signals from HDMI source.
All above HDMI settings need proper HDMI source device. If HDMI source products does not support these features, the TV may not work properly by activating these features.

Note: If your HDMI connection is capable of 1080p and/or your TV is capable of refresh rates greater than 60Hz or supports Deep Color, you will need a Category 2 cable. Conventional HDMI/DVI cables may not work properly with this mode.

To set the HDMI Settings:

- 1 Select the appropriate HDMI input mode (HDMI 1, HDMI 2, or HDMI 3).
- 2 Press **MENU** and open the **Setup** menu.
- 3 Highlight **HDMI Settings** and press **ENTER**.
- 4 Press **▲** or **▼** to highlight the item you want to set.

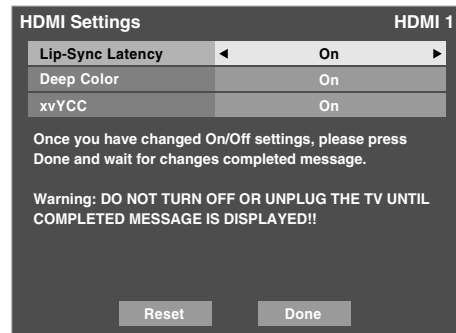

- 5 Press **◀** or **▶** to select **On** or **Off**.
- 6 To save the new settings, highlight **Done** and press **ENTER**. To revert to the factory defaults, highlight **Reset** and press **ENTER**.

Displaying TV status information

To display TV status information using RECALL:

Press **RECALL** on the remote control.

The following information will display (if applicable):

- Current input (**ANT**, **VIDEO 1**, etc.)
- If ANT is the current input, either “CABLE” (for cable TV) or “ANT” (for over-the-air broadcasts).
- Channel number (if in **ANT** mode)
- Channel label (if set)
- Digital signal strength indicator (bar graph in lower right corner of box; for ATSC signal only)
- Stereo, Mono or SAP audio status (when HDMI input mode, Dolby Digital or PCM)
- Video resolution
- Aspect ratio of incoming video signals (4:3 or 16:9)
- V-Chip rating status
- GameTimer (if set)
- xvYCC status of incoming signal



To close the RECALL screen:

Press **RECALL** again.

To display TV status information using INFO:

Press **INFO** on the remote control.

The following additional information will display for off air digital channels (if applicable):

- Title
- Duration
- Detailed description

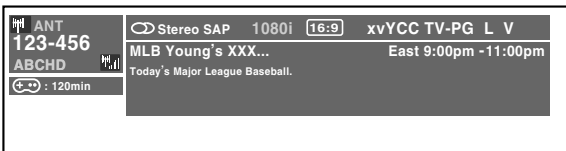

Note: The location of the banner can be moved to the top or bottom of the screen by pressing **▲** or **▼** while the **RECALL** or **INFO** display is on-screen. (The last position will be stored to memory.)

Understanding the auto power off feature

The TV will automatically turn itself off after approximately 15 minutes if it is tuned to a vacant channel or a station that completes its broadcast for the day. This feature functions in **ANT** mode only.

Understanding the last mode memory feature

If the power is cut off while you are viewing the TV, the Last Mode Memory feature automatically turns on the TV when the power is resupplied.

Note: You should unplug the TV's power cord if it is possible that you will be away from the TV for an extended period of time after the power is restored.

Chapter 7: Using the TV's advanced features

Using the advanced picture settings features

Using dynamic contrast

When dynamic contrast is set to **Low**, **Middle**, or **High**, the TV will detect changes in the picture quality that affect the appearance of your contrast settings and then automatically adjust the video.

To select dynamic contrast preferences:

- 1 Press **MENU** and open the **Video** menu.
- 2 Highlight **Picture Settings** and press **ENTER**.

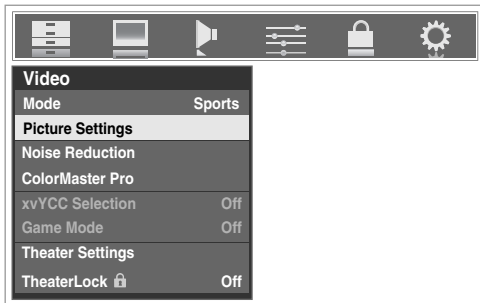

- 3 Highlight **Advanced Picture Settings** and press **ENTER**.

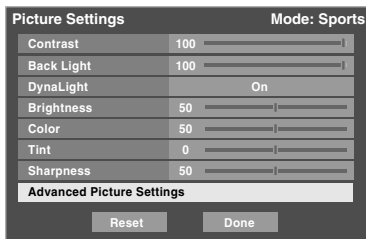

- 4 In the **Dynamic Contrast** field, select either **Off**, **Low**, **Middle** or **High**.



- 5 To save the new settings, highlight **Done** and press **ENTER**. To revert to the factory defaults, highlight **Reset** and press **ENTER**.

Note: If you select one of the factory-set picture modes (**Sports**, **Standard**, **Movie**, or **Document**) and then change the dynamic contrast setting, the picture mode automatically changes to **Preference**.

Using the static gamma feature

The static gamma feature allows you to adjust the levels of black in the picture.

To adjust the static gamma settings:

- 1 Press **MENU** and open the **Video** menu.
- 2 Highlight **Picture Settings** and press **ENTER**.

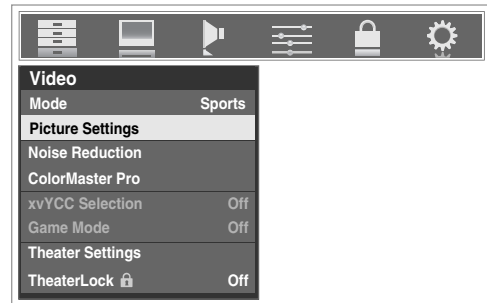

- 3 Highlight **Advanced Picture Settings** and press **ENTER**.

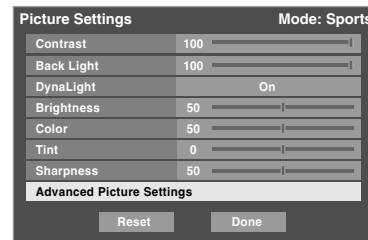

- 4 In the **Static Gamma** field, press **◀** or **▶** to adjust the static gamma.

The adjustment range is within ± 4 from center.

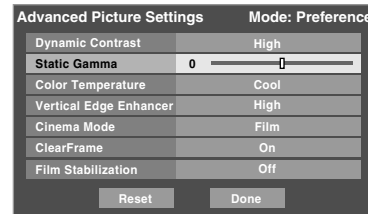

- If the setting is moved in the minus direction, the detail of black colors will be decreased.
- If the setting is moved in the plus direction, the detail of black colors will be increased.

- 5 To save the new settings, highlight **Done** and press **ENTER**. To revert the factory defaults, highlight **Reset** and press **ENTER**.

Note: If you select one of the factory-set picture modes (**Sports**, **Standard**, **Movie**, or **Document**) and then change the static gamma setting, the picture mode automatically changes to **Preference**.

Selecting the color temperature

You can change the quality of the picture by selecting from three preset color temperatures (Cool, Medium, and Warm), as described below.

Mode	Picture Quality
Cool	blueish
Medium	neutral
Warm	reddish

To select the color temperature:

- 1 Press **MENU** and open the **Video** menu.
- 2 Highlight **Picture Settings** and press **ENTER**.
- 3 Highlight **Advanced Picture Settings** and press **ENTER**.
- 4 Highlight **Color Temperature** and press **ENTER**.

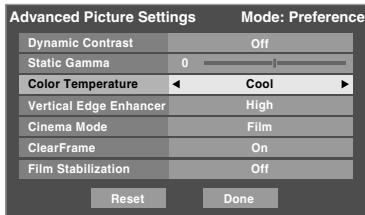

- 5 In the **Color Temperature** field, select the mode you prefer (**Cool**, **Medium**, or **Warm**).



- 6 Press **▲** or **▼** to select either **B Drive** or **G Drive**, and then press **◀** or **▶** to adjust the settings.



- B Drive: **▶** makes the picture blueish.
- G Drive: **▶** makes the picture greenish.

Note: The **B Drive** and **G Drive** settings are connected to the **Color Temperature** settings and will change based on which setting is selected in step 5 above.

- 7 To save the new settings, highlight **Done** and press **ENTER**. To revert to the factory defaults, highlight **Reset** and press **ENTER**.

Note: If you select one of the factory-set picture modes (**Sports**, **Standard**, **Movie**, or **Document**) and then change the color temperature mode, the picture mode automatically changes to **Preference**.

Using the Vertical Edge Enhancer feature

The Vertical Edge Enhancer feature strengthens video contour.

To turn on the Vertical Edge Enhancer feature:

- 1 Press **MENU** and open the **Video** menu.
- 2 Highlight **Picture Settings** and press **ENTER**.
- 3 Highlight **Advanced Picture Settings** and press **ENTER**.
- 4 In the **Vertical Edge Enhancer** field, select the mode you prefer (**Off**, **Low**, **Middle**, or **High**).

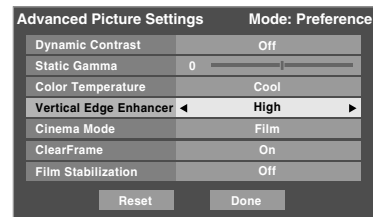

- 5 To save the new settings, highlight **Done** and press **ENTER**. To revert to the factory defaults, highlight **Reset** and press **ENTER**.

Note:

- If you select one of the factory-set picture modes (**Sports**, **Standard**, **Movie**, or **Document**) and then change the Vertical Edge Enhancer setting, the picture mode automatically changes to **Preference**.
- When the input is changed to PC, this feature is automatically set to **High** and grayed out in the menu.

Selecting the cinema mode (480i and 1080i signals)

When you view a DVD (3:2 pulldown processed) from a DVD player connected to the **VIDEO 1**, **VIDEO 2**, **ColorStream HD-1**, **ColorStream HD-2** (component video), or **HDMI** inputs on the TV, smoother motion can be obtained by setting the **Cinema Mode** to **Film**.

To set the Cinema Mode to Film:

- 1 Press **MENU** and open the **Video** menu.
- 2 Highlight **Picture Settings** and press **ENTER**.
- 3 Highlight **Advanced Picture Settings** and press **ENTER**.
- 4 In the **Cinema Mode** field, select **Film**.

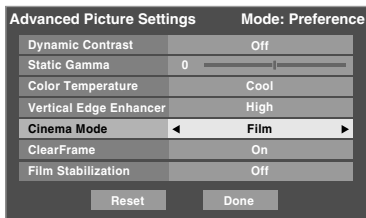

- 5 To save the new settings, highlight **Done** and press **ENTER**. To revert to the factory defaults, highlight **Reset** and press **ENTER**.

To set the Cinema Mode to Video:

Select **Video** in step 4 above.

Note: When the **Cinema Mode** is set to **Video**, the **Film Stabilization** feature (see page 80) will not be available (grayed out and set to **Off**).

Using the ClearFrame™ feature

The new ClearFrame 120 Hz anti-blur technology doubles the frame rate from 60 frames per second to 120 frames per second, virtually eliminating motion blur without adding flicker or reducing image brightness.

To turn on the ClearFrame:

- 1 Press **MENU** and open the **Video** menu.
- 2 Highlight **Picture Settings** and press **ENTER**.
- 3 Highlight **Advanced Picture Settings** and press **ENTER**.
- 4 In the **ClearFrame** field, select **On**.

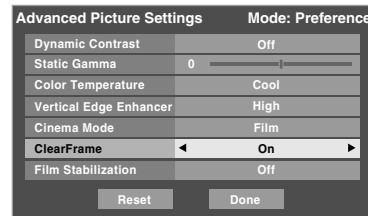

- 5 To save the new settings, highlight **Done** and press **ENTER**. To revert to the factory defaults, highlight **Reset** and press **ENTER**.

Note:

- If you select one of the factory-set picture modes (**Sports**, **Standard**, **Movie**, or **Document**) and then change the **ClearFrame** setting, the picture mode automatically changes to **Preference**.
- When the **ClearFrame** is set to **Off**, the **Film Stabilization** feature (see page 80) will not be available (grayed out and set to **Off**).

Using the Film Stabilization feature

This feature helps to eliminate video shaking that can occur when **Cinema Mode** is set to **Film** (3:2 pull down process enabled).

To turn on Film Stabilization:

- 1 Press **MENU** and open the **Video** menu.
- 2 Highlight **Picture Settings** and press **ENTER**.
- 3 Highlight **Advanced Picture Settings** and press **ENTER**.
- 4 In the **Film Stabilization** field, select **On**.

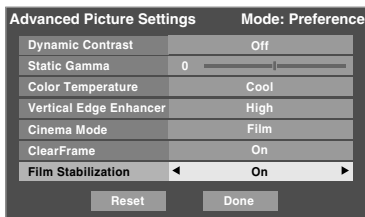

- 5 To save the new settings, highlight **Done** and press **ENTER**. To revert to the factory defaults, highlight **Reset** and press **ENTER**.

Note:

- If you select one of the factory-set picture modes (**Sports**, **Standard**, **Movie**, or **Document**) and then change the Film Stabilization setting, the picture mode automatically changes to **Preference**.
- When the **Cinema Mode** is set to **Video** or the **ClearFrame** is set to **Off** (see page 79), **Film Stabilization** will be grayed out and set to off automatically.

Using CableClear® digital noise reduction

The CableClear® digital noise reduction feature allows you to reduce visible interference in your TV picture. This may be useful when receiving a broadcast with a weak signal (especially a Cable channel) or playing a noisy video tape or disc.

To change the CableClear settings:

- 1 Press **MENU** and open the **Video** menu.
- 2 Highlight **Noise Reduction** and press **ENTER**.

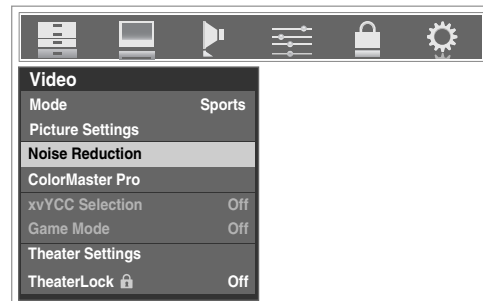

- 3 In the **CableClear** field, select your desired setting.



Note:

- If the current input is **ANT**, **VIDEO 1**, or **VIDEO 2**, the menu will display the text "CableClear." The available selections are **Off**, **Auto**, **Low**, **Middle**, and **High**.
- If the current input is **ColorStream HD1**, **ColorStream HD2**, **HDMI 1**, **HDMI 2**, or **HDMI 3**, the menu will display the text "DNR." The available selections are **Off**, **Auto**, **Low**, **Middle**, and **High**. **Auto** will react proportionally to the strength of the noise. **Low**, **Middle**, and **High** will reduce the noise in varying degrees, from lowest to highest, respectively.

- 4 To save the new settings, highlight **Done** and press **ENTER**. To revert to the factory defaults, highlight **Reset** and press **ENTER**.

Using MPEG noise reduction

The MPEG noise reduction feature allows you to reduce visible interference caused by MPEG compression. Choices for MPEG noise reduction are **Off**, **Low**, **Middle**, and **High**. **Off** is automatically selected when this feature is disabled (“grayed out”).

To select the MPEG noise reduction level:

- 1 Press **MENU** and open the **Video** menu.
- 2 Highlight **Noise Reduction** and press **ENTER**.
- 3 Press **▲** or **▼** to highlight the **MPEG Noise Reduction** field, and then press **◀** or **▶** to select either **Off**, **Low**, **Middle** or **High**.



- 4 To save the new settings, highlight **Done** and press **ENTER**. To revert to the factory defaults, highlight **Reset** and press **ENTER**.

Using the ColorMaster™ Pro feature

The ColorMaster Pro feature allows you to adjust standard colors as well as create 3 custom user colors. The menu will consist of 3 items: ColorMaster Pro, Color Palette Adjustment, and Reset.

To turn on ColorMaster Pro:

- 1 Press **MENU** and open the **Video** menu.
- 2 Highlight **ColorMaster Pro** and press **ENTER**.

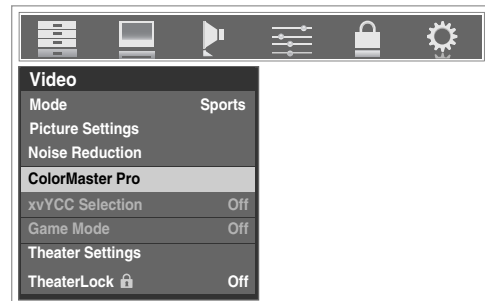

- 3 In the **ColorMaster Pro** field, select **On**.

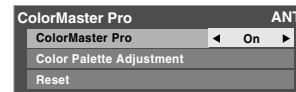

Note: If you select one of the factory-set picture modes (**Sports**, **Standard**, **Movie**, or **Document**) and then change the ColorMaster Pro setting, the picture mode automatically changes to **Preference**.

To turn off ColorMaster Pro:

Select **Off** in Step 3 above.

Using Color Palette Adjustment

When Color Palette Adjustment is selected, the list of base colors and user colors will be displayed. You can select a base color to adjust or choose to create a user color.

Note: To use **Color Palette Adjustment**, **ColorMaster Pro** must be set to **On**.

To adjust the Base Colors:

- 1 From the **ColorMaster Pro** menu, highlight **Color Palette Adjustment** and press **ENTER**.



(continued)

- 2** The **Select Standard Color** window will be displayed. Press ▲ or ▼ to highlight the color you want to adjust, and then press **ENTER**.

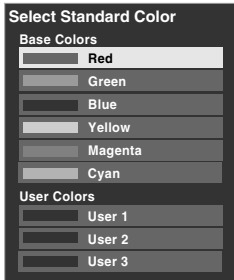

- 3** The **Color Adjustment** window will be displayed. Press **FREEZE** to freeze the picture. To return to moving picture, press **FREEZE** again.

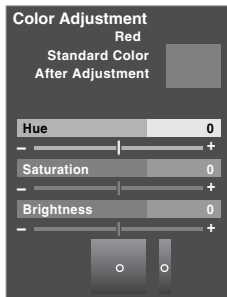

- 4** Press ▲ or ▼ to select either **Hue**, **Saturation**, or **Brightness**, and then press ◀ and ▶ to adjust the setting.

Note: To revert to the factory settings of **Hue**, **Saturation**, and **Brightness** for the selected color, press **A**.

- 5** Press **CH RTN** to return to the previous menu.
6 Repeat steps 2 through 5 to adjust any other color.

To create a User Colors:

- 1** From the **ColorMaster Pro** menu, highlight **Color Palette Adjustment**, and then press **ENTER**.
2 The **Select Standard Color** window will be displayed. Press ▲ or ▼ to highlight either **User 1**, **User 2**, or **User 3**, and then press **ENTER**.

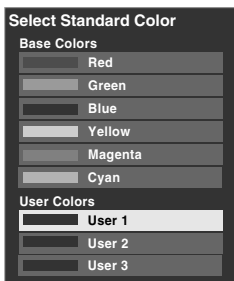

- 3** The **Color Adjustment** window will be displayed. Press ▲ or ▼ to highlight **Change Standard Color**, and then press **ENTER**.

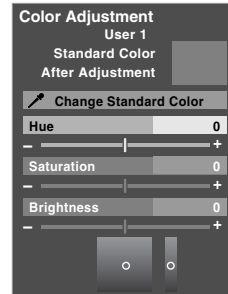

The video on-screen will automatically freeze and the cross hairs will appear on the video.

Note: Release the video anytime by pressing **FREEZE**.

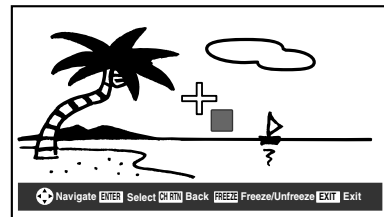

- 4** Press ▲▼◀▶ to move the cross hairs to the color you want to adjust, and then press **ENTER**.



- 5** Press ▲ or ▼ to select either **Hue**, **Saturation**, or **Brightness**, and then press ◀ or ▶ to adjust the setting.

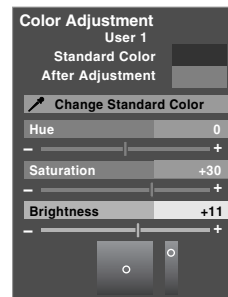

Note: You can reset the **Hue**, **Saturation**, and **Brightness** to "0" for any user color by pressing **A**.

- 6** Repeat step 5 for other items.
7 Press **EXIT**.

To reset ColorMaster to its factory settings:

- 1 From the **ColorMaster** menu, highlight **Reset**, and then press **ENTER**.

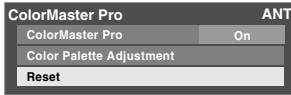

- 2 A confirmation message will appear. Highlight **OK**, and then press **ENTER**.



- 3 Press **EXIT**.

Using xvYCC Selection feature

The color range “xvYCC” is an international standard and enables a wider color range than conventional video applications.

If the **xvYCC Selection** is set to **Auto**, your TV will automatically detect images supported by xvYCC.

Note: If a non-HDMI input is selected or the **xvYCC** setting in the **HDMI Settings** menu is set to **Off**, this feature will appear grayed out in the **Video** menu.

To change the xvYCC Selection:

- 1 Press **MENU**, and open the **Video** menu.
- 2 Press **▲** or **▼** to highlight **xvYCC Selection**, and then press **◀** or **▶** to select the settings you prefer (**Auto**, **On** or **Off**).

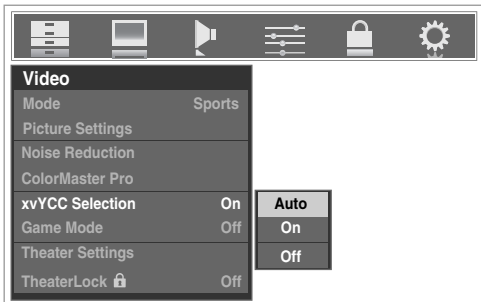

Using the Game Mode feature

You can use the Game Mode feature for shorter frame delays when playing a video game requiring split-second timing between the on-screen display and input from the controller (such as music creation and high-action games).

This feature is more effective for 480i and 1080i input signals.

Note: To use the Game Mode feature, the current video input must be **Video 1**, **Video 2**, **ColorStream HD1**, **ColorStream HD2**, **HDMI 1**, **HDMI 2**, or **HDMI 3**. The Game Mode cannot be turned on when any other video input is selected.

To turn on Game Mode:

- 1 Press **MENU** and open the **Video** menu.
- 2 Press **▲** or **▼** to highlight the **Game Mode** field, and then press **◀** or **▶** to select **On**.

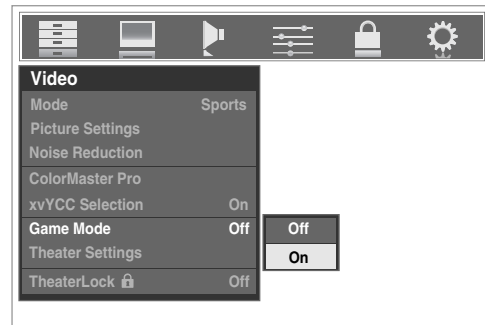

To turn off Game Mode:

Select **Off** in step 2 above, change the video input, or turn the TV off and then on again.

Note:

- You can change the video input by pressing **INPUT** on the remote control (see page 51).
- When the **Game Mode** is set to **On**, the following features (see pages 79 and 80) are not available (grayed out).
 - Cinema Mode: grayed out and set to Video
 - Clear Frame: grayed out and set to Off
 - Film Stabilization: grayed out and set to Off

Using the advanced audio settings features

Using the SRS WOW™ surround sound feature

SRS WOW™ is a special combination of SRS Labs audio technologies (SRS 3D, SRS Focus, and SRS TruBass) that creates a thrilling surround sound experience with deep, rich bass from stereo sound sources. Your TV's audio will sound fuller, richer, and wider.

To adjust the WOW™ settings:

- 1 Put the TV in **STEREO** mode (🔊 “Selecting stereo/SAP broadcasts” on page 64).
- 2 Press **MENU** and open the **Audio** menu.
- 3 Highlight **Advanced Audio Settings** and press **ENTER**.
- 4 Press **▼** or **▲** to highlight the WOW feature you want to adjust, and then press **◀** or **▶** to adjust the item.

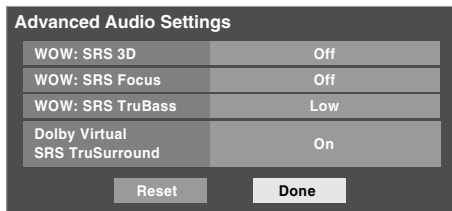

- **WOW: SRS 3D** — To turn the surround sound effect **On** or **Off**.
Note: If the broadcast is monaural, the SRS 3D effect will not work.
 - **WOW: SRS Focus** — To turn the vocal emphasis effect **On** or **Off**.
 - **WOW: SRS TruBass** — To select the desired bass expansion level (**Off**, **Low**, or **High**).
- 5 To save the new settings, highlight **Done** and press **ENTER**. To revert to the factory defaults, highlight **Reset** and press **ENTER**.

WOW, TruSurround, SRS and  symbol are trademarks of SRS Labs, Inc.

WOW and TruSurround technologies are incorporated under license from SRS Labs, Inc.

Using the virtual surround sound feature (Dolby® Virtual and SRS TruSurround™)

The Dolby Virtual and SRS TruSurround feature allows you to enjoy virtual surround sound from the TV's speakers.

To turn on the Dolby Virtual and SRS TruSurround feature:

- 1 Press **MENU** and open the **Audio** menu.
- 2 Highlight **Advanced Audio Settings** and press **ENTER**.
- 3 In the **Dolby Virtual and SRS TruSurround** field, select **On**.

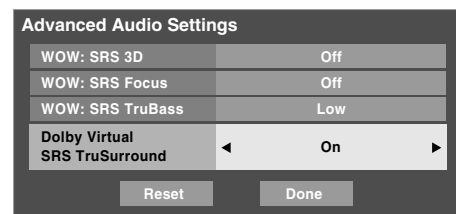

- 4 To save the new settings, highlight **Done** and press **ENTER**. To revert to the factory defaults, highlight **Reset** and press **ENTER**.

To turn off the Dolby Virtual and SRS TruSurround feature:

Select **Off** in step 3 above.

*Note: The **Dolby Virtual** and **SRS TruSurround** and **WOW SRS 3D** features cannot be on at the same time. If you set one to **On**, the other will automatically be set to **Off**.*

Using the Help feature

The Help feature provides explanations for commonly misunderstood behavior using a friendly menu format.

To open the Help menu:

- 1 Press **MENU** and open the **Applications** menu.
- 2 Highlight **Help** and press **ENTER**.

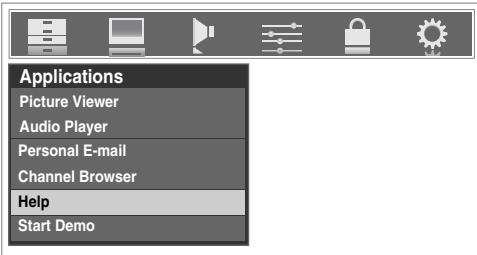

- 3 The Help top menu will appear. Select the item you want to display.

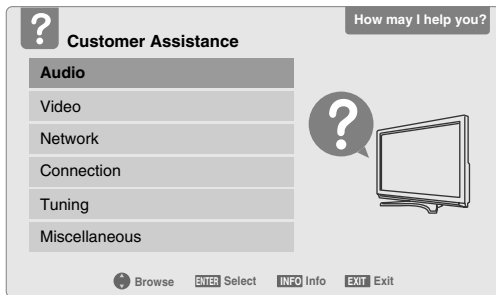

Controlling the Help Feature:

- **▲▼◀▶** will allow movement (change of focus) around the window.
- **ENTER** will select an item and show the contents of that item, or take action if the item has an associated action.
- **CH RTN** will return to the previous item.
- **INFO** will display helpful information about the currently selected item.
- **EXIT** will close the Help menu.

Help Main Menu

The main menu consists of the following 6 major categories:

- **Audio:** Issues related to audio processing, output, settings, etc.
- **Video:** Issues related to video processing, output, settings, etc.
- **Network:** Issues related to the network features on the TV.
- **Connection:** Issues related to connection of external devices.
- **Tuning:** Issues related to tuning of various types of channels.
- **Miscellaneous:** Important issues that do not fit into the other categories.

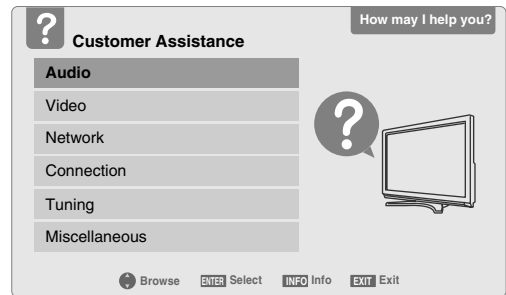

Press **▲** or **▼** to select your desired category and press **ENTER**. The subgroups menu will appear (see below).

Help Subgroups

Each major category will consist of the following 3 subgroups:

- **FAQ List** (Frequently Asked Questions) provides answers to common user questions about the selected category.
- **HowTo List** provides guidance on how to perform certain operations on the TV.
- **Diagnostics List** provides users with information on how to diagnose problems they are experiencing.

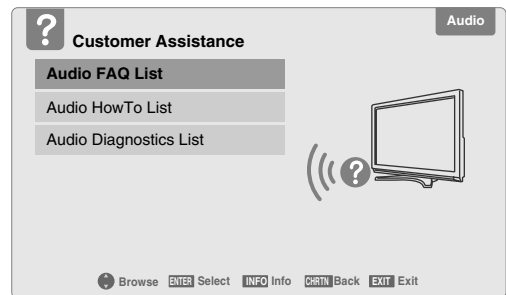

To select a subgroup:

Press **▲** or **▼** to select a subgroup and press **ENTER**.

(continued)

Specific Help Items

Within each subgroup, there will be a list of related items. From this window, you can select a specific topic by using ▲ ▼ ◀ ▶ and **ENTER**.

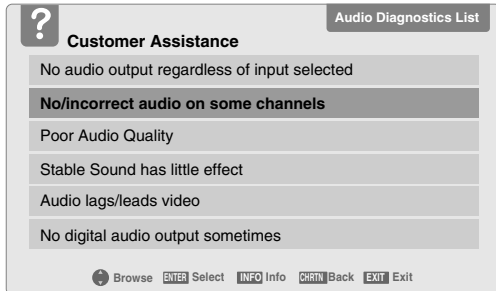

Operational Items

Certain windows will provide not only information, but will also allow you to actually perform some operation on the TV. For example, in the following case, you will be able to turn off the SAP audio feature on the TV by simply selecting this item from the list and pressing **ENTER** with the focus on **OK**.

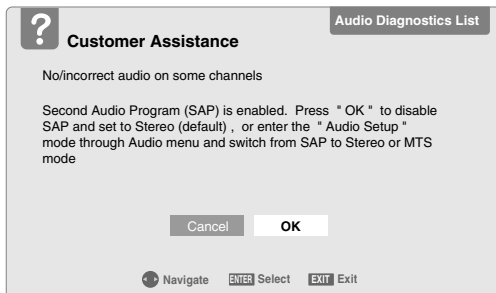

Once the operation has been successfully completed, a confirmation message will be shown.

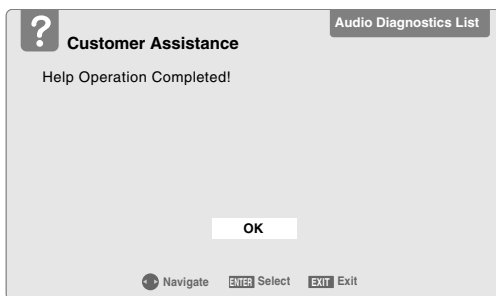

After you select **OK**, the window will transition back to the previous list with the last item still highlighted.

Chapter 8: Using the THINC™ home network feature

The **Toshiba Home Interactive Network Connection (THINC™)** feature allows you to connect the TV to your home network, which will enable access to file sharing and personal e-mail features.

File sharing

You can access JPEG and MP3 files that are stored on your networked home PC and view/play them on the TV.

Note: Requires a home network* (☞ page 24). Does NOT require Internet/e-mail service.

Personal E-mail

The Personal E-mail feature allows you to access your e-mail server through the TV.

Note:

- **Contact your Internet Service Provider (ISP) to obtain and set up Internet/e-mail service.**
- **You will NOT be able to access or browse the Internet through the TV.**

Follow the steps in sections A through D (☞ pages 87–93) to set up and use the TV's home network features.

* The TV's home network feature is compatible with **Microsoft® Windows® 2000** and **Microsoft® Windows® XP Home/Professional SP2** or higher.
Microsoft and Windows are either registered trademarks or trademarks of Microsoft Corporation in the United States and/or other countries.

A. Connecting the TV to your home network

1 Connect the TV to your home network via the TV's RJ-45 (Ethernet) port. See pages 24 and 25 for connection instructions.

2 If you want to use file sharing only and do not have Internet service in your home:

Go to section B, "Setting up the network address," on the next page.

Note: If you do not have Internet service, you will not be able to use the Personal E-mail feature.

If you want to use file sharing and personal e-mail:

- a) You must have Internet service in your home and your personal e-mail address. Contact your ISP to obtain and set up Internet/e-mail service in your home.
- b) After you have obtained Internet/e-mail service in your home (from your ISP), go to section B, "Setting up the network address" on the next page.

For home network troubleshooting tips, see Chapter 9.

The unauthorized recording, use, distribution, or revision of television programs, videotapes, DVDs, and other materials is prohibited under the Copyright Laws of the United States and other countries, and may subject you to civil and criminal liability.

B. Setting up the network address

To set up the network address:

- 1 First, try automatically setting up the network address (below).
- 2 If the automatic setup is not successful, you can **either** retry the automatic setup (below) **or** try manually setting up the network address (ⓘ page 89).

Note:

- If you used an Ethernet crossover cable to connect your PC directly to the TV, you will not be able to use the automatic setup, and must manually set up the network address.
- If you used a hub or switch to connect the TV to your home network, you will not be able to use the automatic setup, and must manually set up the network address.
- If you used a router with built-in DHCP functionality, use the automatic setup. Manual setup may not work.

Router technology, like all new and emerging technologies, may from time to time cause compatibility issues because of the differences in router systems implemented by the various router manufacturers; however, most issues can be easily resolved. If you think your Toshiba TV and router might have compatibility problems, please contact the following:

- **In the U.S.**, call TACP Consumer Solutions at **1-800-575-5469** or visit <http://www.tacp.com/customersupport/contact.asp>.
- **In Canada**, call TCL Customer Service at **1-800-268-3404** or visit <http://www.toshiba.ca>.

Automatically setting up the network address

- 1 Press **MENU** and open the **Setup** menu.
- 2 Highlight **Installation** and press **ENTER**. The **Installation** menu appears.
- 3 Open the **Network** menu.
- 4 Highlight **Basic Network Setup** and press **ENTER**.

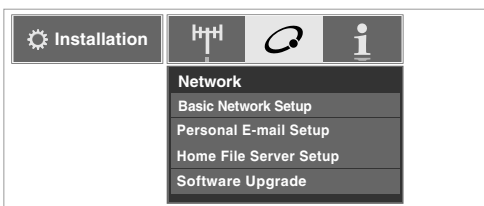

- 5 The message “Obtain network address automatically?” will display. Highlight **Yes** and press **ENTER**.

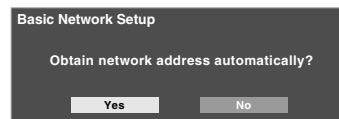

- 6 The message “Please wait...” will display while the TV is attempting to load the network address information from the DHCP server.

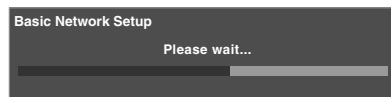

If the automatic network address setup is successful, go to step 7.

If the automatic network address setup is not successful, go to step 8.

- 7 If the automatic network address setup is successful, the following screen will appear:

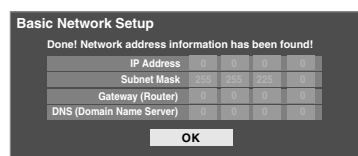

- a) Press **ENTER** to close the screen and return to the **Network** menu.
- b) Skip to section C, “Setting up file sharing on your PC” (ⓘ page 90).

- 8 If the automatic network address setup is **not** successful, the following screen will appear:

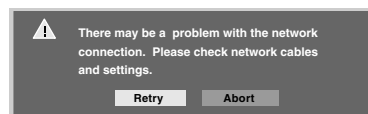

- a) Make sure all cables for your home network are securely connected.
- b) Make sure your home network is set up properly. **See page 24 for TV connection information. Also consult the owner’s manuals for your other components.**
- c) Make sure the DHCP and security settings on your home router are correct. **Consult the owner’s manual for your router.**
- d) Retry the automatic network address setup by following these steps:
 - (1) Highlight **OK** and press **ENTER**.
 - (2) Repeat steps 1–6. **(If you have already repeated this setup process, go to step 9.)**

- 9** If, after repeating steps 1–6, you receive the error message shown in step 8:
- Either...
- Highlight “OK” and press **ENTER**.
 - Go to “Manually setting up the network address.”
- Or...
- Highlight “OK” and press **ENTER**.
 - Continue to sections C, D, and E (pages 90–95) (to set up and use file sharing) and/or to sections F and G (pages 99–102) (to set up and use personal e-mail).
- If the file sharing and/or Personal E-mail features work correctly, then the automatic network address setup was successful (even though the TV displayed the error message).

Manually setting up the network address

This setup requires the data listed below. You can get this data from either your ISP or the configuration utility for your DSL/cable modem or router.

IP address:

Subnet mask:

Gateway (Router) address:

DNS (Domain Name Server) address:

- Press **MENU** and open the **Setup** menu.
- Highlight **Installation** and press **ENTER**. The **Installation** menu appears.
- Open the **Network** menu.
- Highlight **Basic Network Setup** and press **ENTER**.
- The message “Obtain network address automatically?” appears. Highlight **No** and press **ENTER**.

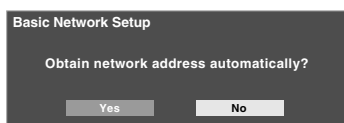

- The **Basic Network Setup** menu appears. Press **▲** or **▼** to highlight the **IP Address** field, and then use the Number buttons on the remote control to input the IP address.

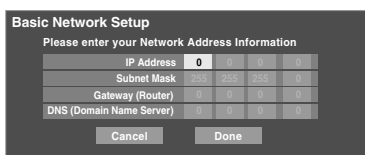

- Press **▼** to highlight the **Subnet Mask** field, and then use the Number buttons to input the Subnet Mask.

- Press **▼** to highlight the **Gateway (Router)** field, and then use the Number buttons to input the Gateway (Router) address.
- Press **▼** to highlight the **DNS (Domain Name Server)** field, and then use the Number buttons to input the DNS address.
- When finished, highlight **Done** and press **ENTER**. The **Basic Network Setup** menu closes and the **Network** menu appears.
- Go to section C, “Setting up file sharing on your PC.”

Resetting the network address

- 1 Press **MENU** and open the **Setup** menu.
- 2 Highlight **Installation** and press **ENTER**. The **Installation** menu appears.
- 3 Open the **Network** menu.
- 4 Highlight **Basic Network Setup** and press **ENTER**.
- 5 The message “Your Basic Network Setup is complete. Would you like to start over?” will appear. To continue, highlight **Yes** and press **ENTER**. To return to the **Network** menu, highlight **No** and press **ENTER**.

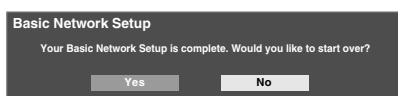

- 6 If you selected **Yes** in step 5, the message “Obtain network address automatically?” will appear.

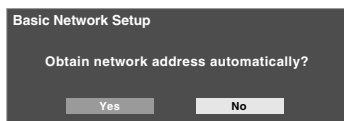

To obtain the network address automatically, go to step 5 under “Automatically setting up the network address” (page 88).

To manually enter the network address, go to “Manually setting up the network address.”

For home network troubleshooting tips, see Chapter 9.

C. Setting up file sharing on your PC

Compatible operating systems

The following operating systems or higher are compatible for file sharing with the TV:

- Microsoft® Windows® XP Service Pack 2 or higher (Home Edition and Professional) [See setup details below]
 - Microsoft® Windows® 2000 [See setup details on page 92]
- No other operating systems are compatible with the TV.

Note:

- The name of any directory/folder on your PC that you are setting up for file sharing with the TV cannot be longer than 12 characters and cannot contain any special characters.
- See “Media specifications” (page 95) for details on compatible JPEG and MP3 files.
- The network (NETBIOS) name of your PC that you are setting up for file sharing must be 15 characters or less.

To determine which operating system and service pack (if applicable) are on your PC:

- 1 On your PC, click the “Start” button.
- 2 Click “Settings | Control Panel.”
- 3 In the Control Panel, double-click “System.”
- 4 Select the “General” tab, which will display your PC’s current operating system and service pack.

Setting up file sharing on a PC with Microsoft® Windows® XP Service Pack 2 or higher

- 1 On your PC:

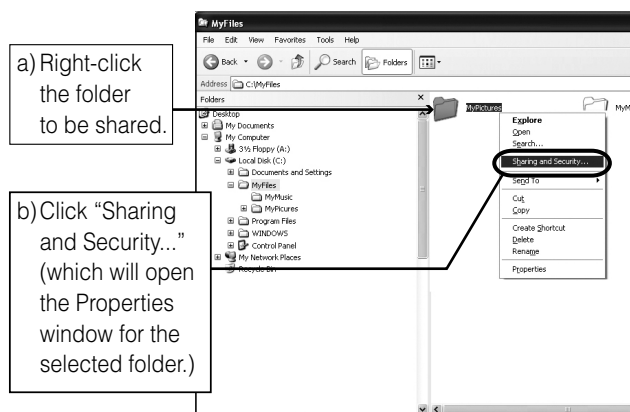

* Microsoft product screen shot(s) reprinted with permission from Microsoft Corporation.

- 2** If the “Sharing” tab on your PC does not have a “Permissions” button, follow step 2.1 below. If the “Sharing” tab on your PC has a “Permissions” button, follow step 2.2 below.

2.1

a) Click to display the “Sharing” tab.

b) Click to select “Share this folder on the network.”

c) Click “OK” (which will close the Permissions window for the selected folder).

Go to section D, “Setting up file sharing on the TV,” on page 93.

2.2

a) Click to display the “Sharing” tab.

b) Click to select “Share this folder.”

c) Click “Permissions” (which will open the Permissions window for the selected folder).

Go to step 3.

- 3** In the Permissions window for the selected folder:

a) Click “Add...” and then select the user to be given sharing privileges.*

*This user must match the user stored in the TV’s “Home File Server Setup” menu.

b) Click to check “Allow” next to “Full Control.”

c) Click “Apply.”

d) Click “OK” to close the window.

Permissions	Allow	Deny
Full Control	<input checked="" type="checkbox"/>	<input type="checkbox"/>
Change	<input checked="" type="checkbox"/>	<input type="checkbox"/>
Read	<input checked="" type="checkbox"/>	<input type="checkbox"/>

- 4** Go to section D, “Setting up file sharing on the TV,” on page 93.

Setting up file sharing on a PC with Microsoft® Windows® 2000

1 On your PC:

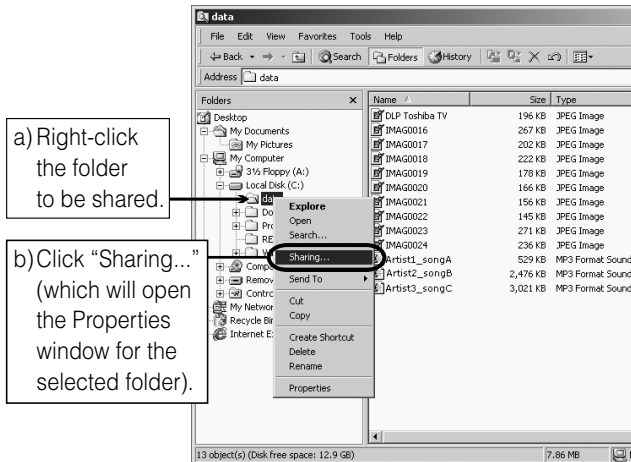

2 In the Properties window for the selected folder:

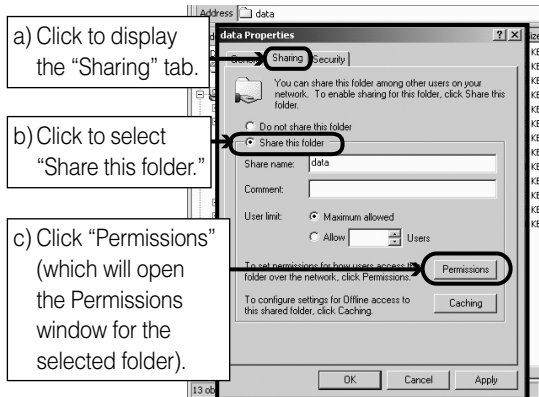

3 In the Permissions window for the selected folder:

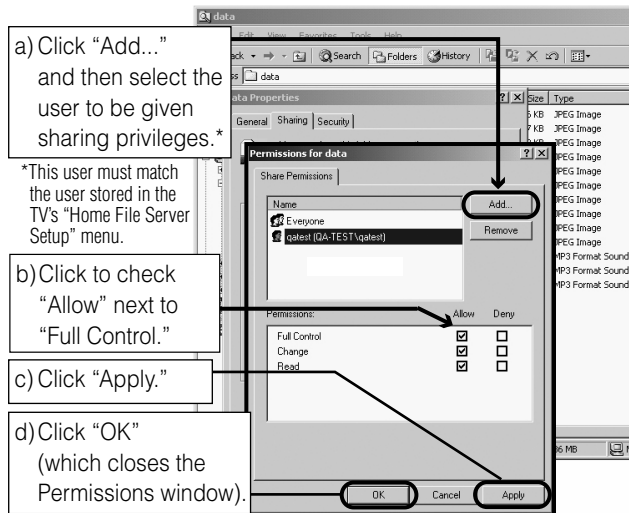

4 In the Properties window:

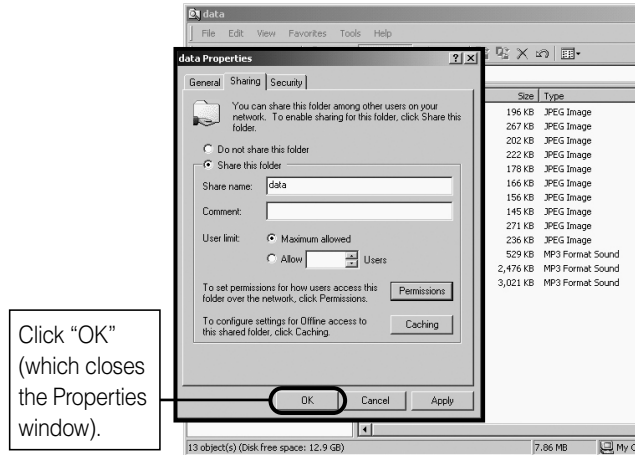

5 The shared folder will display with a "shared folder" icon (a hand holding a folder).

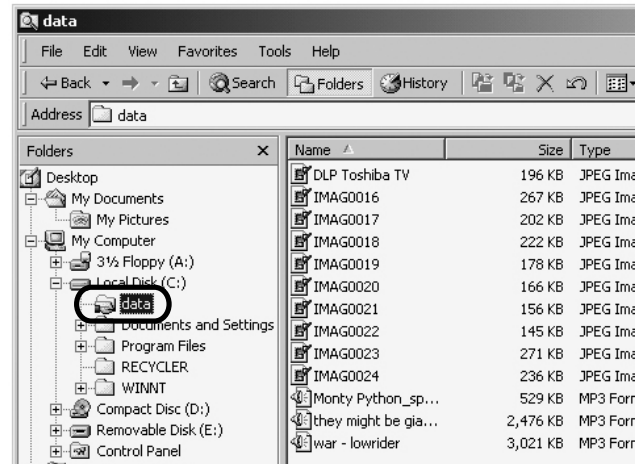

6 Go to section D, "Setting up file sharing on the TV," on the next page.

For home network troubleshooting tips, see Chapter 9.

D. Setting up file sharing on the TV

- 1 Press **MENU** and open the **Setup** menu.
- 2 Highlight **Installation** and press **ENTER**. The **Installation** menu will appear.
Open the **Network** menu.

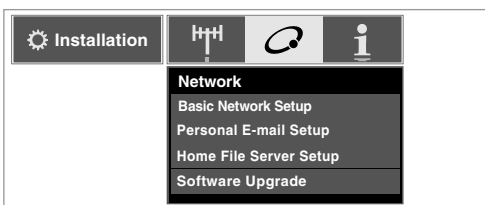

- 3 Highlight **Home File Server Setup** and press **ENTER**. The **Home File Server Setup** window will appear.
After a few moments, the message “Please Wait...” will appear until the network finds your networked PC.
The networked PC will act as the “Home Server” for file sharing with the TV.

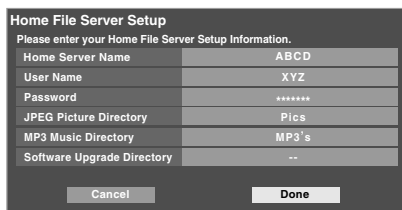

- 4 Press **▲▼** to highlight **Home Server Name**, and then press **◀▶** to select the name of the PC you set up for file sharing.
If you have multiple PCs on your home network that have shared folders, press **◀▶** to select the PC (home server) from which you want to access files.

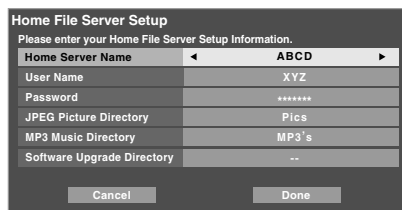

- 5
 - a. Press **▲▼** to highlight **User Name** and then press **ENTER** to open the software keyboard for that field.
 - b. Enter the User Name for your PC using the software keyboard. See “Using the software keyboard” on the next page.
Note: The **User Name** is case sensitive.
 - c. When finished entering all characters, highlight **Done** and press **ENTER**.
- 6 Repeat step 5 for the **Password** field.
Note: The **Password** is case sensitive.

- 7 Press **▲▼** to highlight either **JPEG Picture Directory** or **MP3 Music Directory**.

Note: The first time you highlight either of these fields, the message “Please Wait...” will appear until the field is populated with the files in your PC’s shared folder(s).

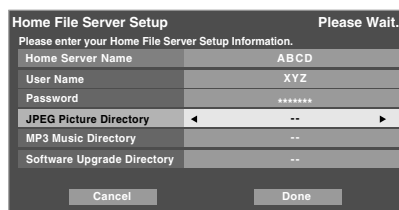

- 8 Press **◀▶** to select the shared folder (on your PC) that contains the JPEG and/or MP3 files you want to view/play on the TV.
Note: Make sure you select the correct folder in this step.
- 9 To exit the window and save your settings, highlight **Done** and press **ENTER**.
To exit the window without saving your settings, highlight **Cancel** and press **ENTER**.

Using the software keyboard

Typing text on the software keyboard is similar to typing text on a cell phone. The number keys on the remote control have corresponding letters or symbols printed next to them.

Repeatedly press a key to cycle through the available characters for that key.

For example, repeatedly pressing the “1” key toggles through several punctuation symbols and the numeral 1; repeatedly pressing the “2” key toggles through the letters a, b, and c, and the numeral 2, and so forth.

To enter text using the software keyboard:

- 1 Repeatedly press the corresponding key on the remote control to highlight the desired character on the on-screen software keyboard.
- 2 The highlighted character is entered after you either press a different key, press the ► key, or after a two-second pause.
- 3 Repeat steps 1 and 2 until you have entered all desired text.

Software keyboard example



- 4 Press **CHRTM** to close the software keyboard and return to the previous screen.

Note: Help instructions are provided in the on-screen display and include specific remote control key functions that are applicable only in certain views.

For example:

◀PAGE **PAGE▶** = page up and down.

◀◀ = Home.

▶▶ = End of Line.

ENTER = New Line.

EXIT = Closes the screen *WITHOUT* saving entries.

About the Software Upgrade feature

Home Network:

This feature allows you to download software updates to your television from a shared folder on your home network. If you experience any difficulties that can only be resolved by a software update, your Toshiba customer service representative will provide you with the appropriate upgrade files and assist you in the proper use of this feature.

Internet:

This feature allows your television to search the Internet for an updated version of its system software. If a newer version of software is available, you will be given the option to download and install it.

Note: Your television must have a working Internet connection in order to use this feature.

E. Viewing/playing shared files on the TV

You can use the **Picture Viewer** to view compatible JPEG-format photos on the TV.

You can use the **Audio Player** to play compatible MP3 files on the TV.

The TV can access JPEG and/or MP3 files stored on a networked PC (as described on pages 96–98 and also see pages 24 and 25).

Note:

- *If you are viewing/playing files stored on a networked PC, IT IS RECOMMENDED THAT YOU BACK UP YOUR DATA. Toshiba is not liable for any damage caused by the use of any networked PC or shared files with this TV. Toshiba will not compensate for any lost data or recording(s) caused by the use of such PCs or data.*
- *The technical criteria set out in this manual are meant as a guide only.*
- **You must obtain any required permission from copyright owners to download or use copyrighted content. Toshiba cannot and does not grant such permission.**

Media specifications

File/folder name specifications

- **Maximum file name length:** 255 characters.
- **Maximum shared folder* name length:** 12 characters.
- **File names must contain** US-ASCII characters only.
- **File and folder names cannot contain** any special characters, such as \ / : ? “ ” < > | .

* The words “folder” and “directory” are used interchangeably.

Picture Viewer/JPEG file specifications

- **Maximum JPEG file size:** 32 MB
 - *JPEG files larger than 32 MB will not display.*
- **Maximum JPEG image resolution:** 1920 × 1080 pixels
 - *Images with a resolution higher than 1920 × 1080 pixels will be scaled.*
- **The Picture Viewer is designed to display** only pictures stored in compatible JPEG formats with a file extension of “.jpg.”
- **JPEG images processed and/or edited on a personal computer (PC)** may not display properly or at all.
- Some digital cameras may store images in a format that is not compatible with the TV.
- **JPEG files stored on a networked PC that are not in a file and folder format compatible with the TV will not display on the TV.**

Audio Player/MP3 file specifications

- **Maximum MP3 file size:** 50 MB
 - *MP3 files larger than 50 MB will not play.*
- **The Audio Player is designed to play** only music files stored in compatible MP3 formats with a file extension of “.mp3”.
- **MP3 files processed and/or edited on a PC** may not play properly or at all. Some MP3 files may be in a format that is not compatible with the TV.
- **MP3 files must be in the following format:**
 - MPEG1 (ISO/IEC 11172-3) Layer3.
 - Sampling frequency—MPEG1: 32 kHz, 44.1 kHz, 48 kHz.
 - Bitrate—MPEG1: 32–320 kbps.
 - Channels—Stereo, Joint stereo, Dual channel, Single channel.
 - ID3 Ver. 1, Ver. 2.
- **The meta-data for MP3 files** (artist name, album name, song title, etc.) must be in the following format:
 - ISO-8859-1 (US-ASCII/ Western European) character sets
- **MP3 files stored on a networked PC that are not in a file and folder format compatible with the TV will not play on the TV.**

(continued)

Viewing JPEG files on the TV

- 1 After accessing your JPEG files from your networked PC (see page 96), the images automatically display on-screen, with one as a large picture and six in thumbnail format.



- 2 Press ◀ to rotate the large picture 90° counterclockwise.



- 3 Press ▶ to rotate the large picture 90° clockwise.



- 4 Press ▲ or ▼ to select another picture as the large picture.
- 5 Press ENTER to view your pictures in a slide show.



During the slide show:

- To stop on an image during the slide show, press ENTER.
 - To resume the slide show, press ENTER again.
 - To rotate the picture, press ◀ or ▶.
 - To select another image, press ▲ or ▼.
- You can zoom in on a picture up to 16x during the slide show.
- To zoom in, press CH.
 - To zoom out, press CH.
- The current magnification will be displayed in the upper left corner of the screen.
- To stop the slide show and return to the picture viewer, press CH RTN.
 - To stop the slide show and return to the regular TV screen, press EXIT.

To set the slide show interval:

- 1 Press EXIT to close the **Picture Viewer** (if it is open).
- 2 Press MENU and open the **Setup** menu.
- 3 Highlight **Slide Show Interval** and press ENTER.
- 4 Select the interval from the menu sidebar (2, 5, 10, 15, or 20 seconds).

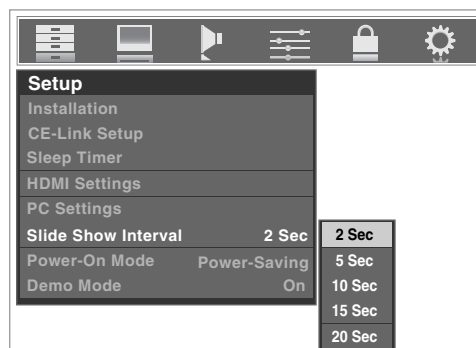

To close the Picture Viewer:

Press EXIT to close the **Picture Viewer** and return to normal TV watching.

Using the Audio Player

You can use the TV's **Audio Player** to listen to MP3 files on the TV.

Note:

- Make all desired adjustments to the TV's audio features (e.g., surround, bass, treble, balance) before starting the **Audio Player**.
- You cannot use the **Picture Viewer** and **Audio Player** at the same time.
- You must obtain any required permission from copyright owners to download or use copyrighted content. Toshiba cannot and does not grant such permission.

Playing MP3 files stored on a networked PC

- 1 Make sure you have correctly set up your home network and file sharing (see pages 87–93; also see pages 24 and 25).
- 2 Press **MENU** and open the **Applications** menu.
- 3 Highlight **Audio Player** and press **ENTER**.



If the network is available, the TV will retrieve the MP3 file through the network.

- 4 Press **▲** or **▼** to access the folder or directory that contains the MP3 files you want to play.

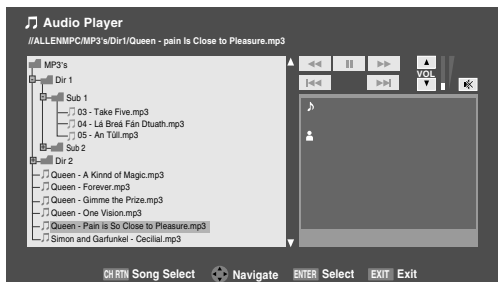

To expand a particular folder to view a list of images, press **▶** on the folder.

To close the folder, press **◀** on the folder.

Pressing **◀** on a file will move the focus up to the folder which contains the file.

Pressing **▶** on a file will move the focus down to the next folder.

If you press **ENTER** on a particular folder, the first file in the folder will display as the first file in the list in Song Select view.

If you press **ENTER** on a particular file, that file will display as the first file in the list in Song Select view.

Note: You can use **CHRTN** to toggle between the thumbnail and folder. The last item selected will be highlighted upon return to the Audio Player.

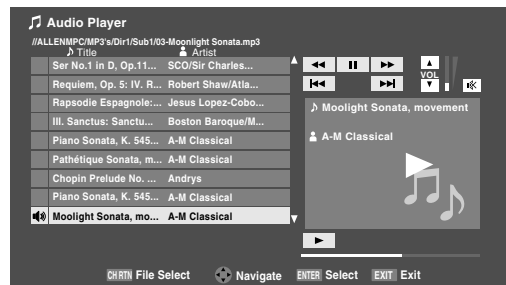

- 5 The **Audio Player** will begin playing the first MP3 file in the list. Press **▲▼◀▶** to navigate to the rewind, pause, fast forward, skip backward, skip forward, volume, and mute buttons—or to select another MP3 file—and then press **ENTER**.

During playback:

- To stop playback, press **PAUSE/STEP**.
- To resume playback, press **PLAY**.
- To restart the same song from the beginning, press **SKIP**.
- Pressing **SKIP** repeatedly skips to previous songs in the song list.
- Pressing **SKIP** skips to the next song in the song list.

To adjust or mute the volume:

Press **(+VOL)** **VOL** or **(MUTE)** on the remote control (see page 64 for details on muting the sound), or press **▲▼◀▶** to navigate to the on-screen **VOL** and **MUTE** (**⏏**) buttons and press **ENTER**.

To close the Audio Player:

Press **EXIT** to close the **Audio Player** and return to the regular TV screen.

F. Setting up the Personal E-mail feature

The Personal E-mail feature allows you to access your e-mail server through the TV.

IMPORTANT NOTE

If you connect the TV to the Internet, anyone with access to the TV will be able to configure the TV to access e-mail accounts for which they have account access information (user name, password and server addresses).

If you set up any personal e-mail accounts on the TV, anyone with access to the TV will be able to read e-mail from those accounts **unless you lock the profile for each e-mail account** (step 8).

You should consider these factors when deciding whether to set up personal e-mail accounts and whether to keep the TV set connected (or make available easy connection) to the internet.

The Personal E-mail Setup will allow up to 4 users to set up profiles from which each profile may access their e-mail account.

Required information and services

Before you can set up the Personal E-mail feature, you must have the following information and related services:

- A valid POP3 e-mail account that you normally use to receive e-mails.
- Login and password settings for above.
- Name or IP address of the incoming (POP3) mail server.

To obtain the required e-mail services listed above, contact your ISP.

To obtain the required addresses and settings listed above, either contact your ISP or use the configuration utility for your DSL/cable modem or router.

Setting up Personal E-mail

- Press **MENU** and open the **Setup** menu.
- Highlight **Installation** and press **ENTER**. The **Installation** menu appears.
- Open the **Network** menu.
- Highlight **Personal E-mail Setup** and press **ENTER**.

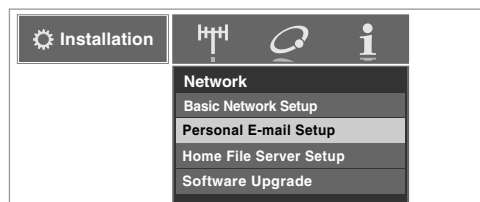

- The **Personal E-mail Setup** window appears. Press **▲** or **▼** to highlight one of the blank profiles and press **ENTER**.

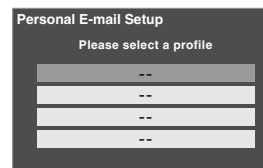

Note: If all four profiles have been created, you can select an existing profile and modify it.

- The **E-mail Profile Setup** window will appear.



Highlight the **Display Name** field and press **ENTER**. The software keyboard will appear.

Software keyboard example

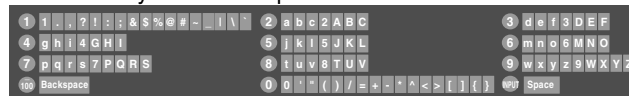

Use the software keyboard to enter the display name. (☞ “Using the software keyboard” on page 94).

- Press **▼** to highlight **Time Zone**, then press **◀** or **▶** to select your desired setting. You can choose from the following options:
Eastern, Central, Mountain, Pacific, Alaska, Hawaii, Atlantic, Newfoundland.
- Press **▼** to highlight **Check for New Mail**, then press **◀** or **▶** to select your desired setting.
 - You can choose to have the TV check for new e-mail every 5, 15, 30 minutes, or 1 hour. When the **Check for New Mail** interval is set to **DISABLED**, new e-mail notifications will not appear.

(continued)

9 You can use the **Profile Lock** to protect your profile settings and prevent other users from viewing your personal e-mails.

Note: Each of the four e-mail profiles must be locked individually.

To lock an e-mail profile:

- Press ▼ to highlight the **Profile Lock** field.
- Press ◀ or ▶ to select **Enabled**.
- Highlight the **Enter PIN Code** field and press **ENTER**.

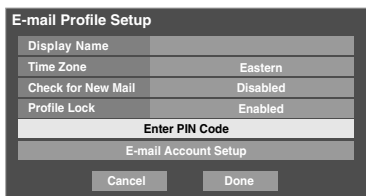

- Use the Number buttons to enter a four-digit PIN code.
- Enter the code a second time to confirm, and then press **ENTER**.

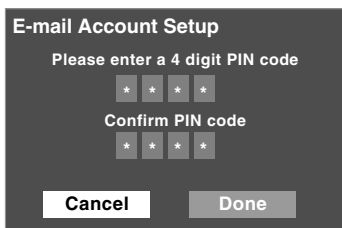

Note: If the profile is already locked, the **E-mail Profile Unlock** window will appear. You must enter the correct PIN code to unlock the account.

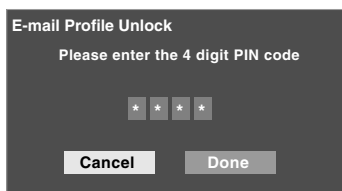

If you cannot remember your PIN code, while the **E-mail Profile Unlock** window is displayed, press **RECALL** four (4) times within five (5) seconds. The PIN code will be cleared and you can enter a new PIN code.

10 Highlight the **E-mail Account Setup** field, and press **ENTER**.

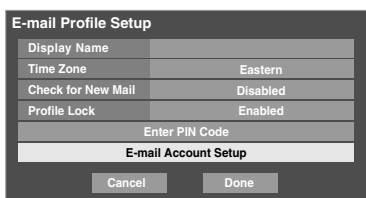

The **E-mail Account Setup** window appears (illustrated below).

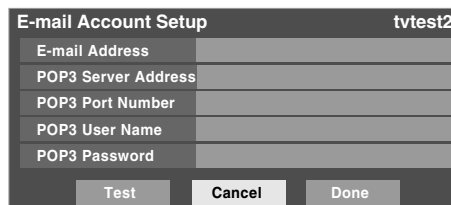

11 Highlight a field and press **ENTER**. The software keyboard will appear (as shown in step 6).

Note: The software keyboard layout will vary based on the buttons that are available for the current item.

Using the software keyboard, enter the appropriate information in the fields.

- E-mail Address
- POP3 Server Address
- POP3 Port Number (uses default if left blank)
- POP3 User Name (same as e-mail account login)
- POP3 Password: password

See “Description of fields in the E-mail Account Setup window” (page 101) for details on the settings for these fields.

12 Highlight **Test** and press **ENTER** to confirm that the e-mail account settings work correctly.

13 When testing is finished, a message will appear indicating whether the e-mail account test passed or not.

If the e-mail account test succeeds, the following message appears:

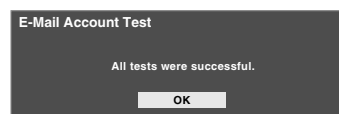

If the e-mail account test fails, the following message appears:

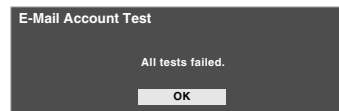

Make sure you entered the correct information for the fields in the **E-mail Account Setup** window.

14 Press **ENTER**.

15 To exit the window and save your settings, highlight **Done** and press **ENTER**.

To exit the window without saving your settings, highlight **Cancel** and press **ENTER**.

Description of fields in the “E-mail Account Setup” window

E-mail Account Setup		tvtest2
E-mail Address	mymail@isp.com	
POP3 Server Address	pop.isp.com	
POP3 Port Number	110	
POP3 User Name	user_name	
POP3 Password	*****	
Test		Cancel
		Done

E-mail Address

Use the software keyboard to enter your personal e-mail address.

POP3 Server Address

Use the software keyboard to enter the POP3 server address that hosts the e-mail account.

Note: The TV does not support encrypted e-mail.

POP3 Port Number

Use the software keyboard to enter the port number used by the user’s POP3 (incoming mail) server. This field is set to 110 by default.

POP3 User Name

Use the software keyboard to enter the e-mail account login. Depending on your ISP, this may be the entire e-mail address or just the characters in the e-mail address before the “@” sign.

POP3 Password

Use the software keyboard to enter the password for the e-mail account.

Note: To help protect your other personal Internet or e-mail accounts, create a password that is significantly different from any of your usual passwords and security PINs (e.g., different from your e-mail password, banking log-ons, social security code, etc.).

For home network troubleshooting tips, see Chapter 9.

(continued)

G. Using the Personal E-mail feature

The Personal E-mail feature allows you to:

- 1) View received messages.
- 2) View attached JPEG files.

In addition, you can create up to four different user e-mail accounts, which can be locked to prevent unwanted access (see page 99).

You can access the Personal E-mail feature in any of the following ways:

- Select **Personal E-mail** from the **Applications** menu.
- Open the **THING** menu and select **Personal E-mail**.
- Press **ENTER** when the “unread e-mail notification” appears (see below).

Unread E-mail Notification

When the TV detects unread e-mail in a user’s inbox, a notification will appear in the bottom right corner of the screen that contains the envelope icon, user’s name, and number of unread messages.



Note:

- You can specify the frequency at which the TV checks for unread e-mails by selecting **Check for New Mail** in the **E-mail Profile Setup** menu (see page 99, step 8).
- The unread e-mail notification will not display when other applications are running (such as the **Picture Viewer** or **Audio Player**).
- The unread e-mail notification will not appear in any video recorded from the TV using the video outputs.

To open the Inbox, press **ENTER** while the unread e-mail notification is on-screen.

To dismiss the unread e-mail notification and continue watching TV, press **EXIT**.

E-mail Inbox

To open the Inbox, press **ENTER** while the unread e-mail notification is on-screen.

In the Inbox view, unread e-mails are denoted by an envelope icon.

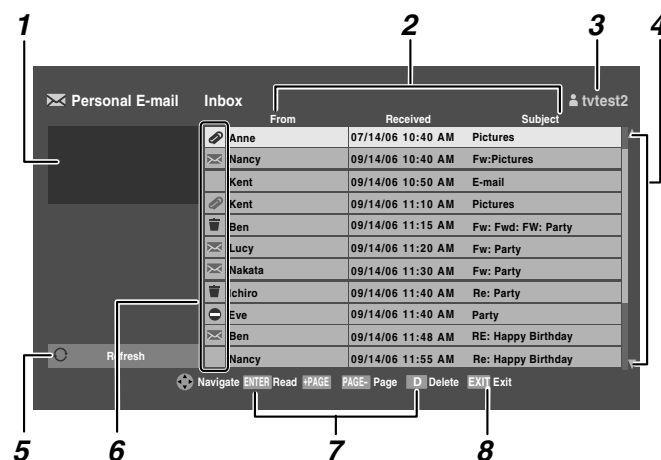

Elements of the Inbox

1 PIP window

When the Inbox is open, you can continue watching the current channel in the PIP (picture-in-picture) window in the upper left corner of the screen. You can change channels in the PIP window by pressing **CH** / **CH** on the remote control.

2 From, Received, and Subject information.

3 User name

4 Scroll arrows

Press **▲**/**▼** to scroll through messages one-by-one. Press **◀PAGE** / **PAGE▶** to scroll through messages page by page. The Inbox can hold a maximum of 100 messages.

5 Refresh button

The Refresh button checks for new messages and deletes messages marked with the Trash Can icon (see below). To refresh the Inbox, highlight the Refresh button and press **ENTER**.

6 The following icons convey information about messages in the Inbox:

Trash Can icon

The Trash can icon denotes a message marked for deletion. To mark a message for deletion, highlight the message and press **D**. To unmark the message (and remove the trash can icon), press **D** again. To delete all messages marked with the Trash Can icon, refresh the Inbox (see item 5, above).

Envelope icon

The Envelope icon denotes a new, unread message. After the message is viewed, the envelope icon disappears.

 **Envelope with paperclip icon**

The Envelope with paperclip icon denotes a new message with an attachment.

 **Paperclip icon**

The Paperclip icon denotes a message with an attachment.

 **“No Entry” icon**

The No Entry icon denotes a message that is too large to open. The maximum allowable message size is 300 KB.

Note: If you delete an e-mail on the TV, it will also be deleted from the e-mail server identified in the account setup—even if the message indicates that it cannot be read by the TV.

7 Read, Delete

From the Inbox view, you can delete messages by pressing the appropriate button (as shown in the guide at the bottom of the screen).

Note: If you delete an e-mail on the TV, it will also be deleted from the e-mail server identified in the account setup—even if the message indicates that it cannot be read by the TV.

8 Exit

Press **[EXIT]** to close the Personal E-mail feature and return to the regular TV screen on the last channel viewed.

Read View

To read e-mail:

From the E-mail Inbox window, highlight the e-mail you want to read and press **[ENTER]**. The Read view (illustrated below) will appear.



From the Read view, press **▲ ▼** to scroll up and down to view the entire message.

To view a JPEG attachment using the Picture Viewer, highlight the Paperclip icon and press **[ENTER]**.

To return to the Read View from the Picture Viewer, press **[EXIT]**.

To return to the Inbox View from the Read view, press **[CH RTN]**.

To close the Personal E-mail feature and return to normal TV watching on the last channel viewed, press **[EXIT]** at any time.

Chapter 9: Troubleshooting

General troubleshooting

Before calling a service technician, please check this chapter for a possible cause of the problem and some solutions to try.

Black box on-screen

- The closed caption feature is set to one of the Text modes (**T1**, **T2**, **T3**, or **T4**). Set the closed caption feature to **Off** (☞ page 62).

TV stops responding to controls

- If the TV stops responding to the controls on the remote control or TV control panel and you cannot turn off the TV, press and hold the **POWER** button on the TV control panel for 5 or more seconds to reset the TV.

Other problems

- If your TV's problem is not addressed in this Troubleshooting section or the recommended solution has not worked, use the Reset Factory Defaults procedure (☞ page 49).

TV will not turn on

- Make sure the power cord is plugged in, and then press **POWER**.
- The remote control batteries may be dead. Replace the batteries or try the control panel buttons.

Picture problems

General picture problems

- Check the antenna/cable connections (☞ Chapter 2).
- Press **(INPUT)** on the remote control or TV and select a valid video input source (☞ page 51). If no device is connected to a particular input on the TV, no picture will display when you select that particular input source. For device connection details, see Chapter 2.
- Antenna reception may be poor. Use a highly directional outdoor antenna (if applicable).
- The station may have broadcast difficulties. Try another channel.
- Adjust the picture qualities (☞ page 60).
- If you are using a VCR, make sure **TV/VIDEO** on the remote control is set correctly (☞ page 28).
- Do not connect both a standard video cable and an S-video cable to the **VIDEO 1** input at the same time (☞ page 16).

Noisy picture

- If you are watching an analog channel (off-air broadcast or Cable TV), you can set the **CableClear®/DNR** feature to **AUTO** to reduce visible interference in the TV picture (☞ page 80).

Video Input Selection problems

- If the **Input Selection** window does not appear when you press **(INPUT)** on the remote control or TV, press **(INPUT)** a second time, which will change to the next video input source and display the **Input Selection** window.

Cannot view external signals or channel 3 or 4

- If you cannot view signals from external devices connected to **VIDEO 1**, **VIDEO 2**, **ColorStream®**, **HDMI 1**, **HDMI 2**, **HDMI 3**, **PC**, or from channels 3 or 4, make sure the **Input Lock** is set to **Off** (☞ page 70).

Poor color or no color

- The station may have broadcast difficulties. Try another channel.
- Adjust the **Tint** and/or **Color** (☞ page 61).

POP problems

- If you label all of the inputs as "**Hide**," the POP feature will be disabled. If you then attempt to access the POP feature, the message "Not Available" will appear (☞ page 59).

Poor composite or S-video picture

- If the TV is connected to an external A/V device (e.g., DVD player, video game system, set-top box, etc.) try using a **ColorStream** or **HDMI** video connection instead.
- If you connect an S-video cable, be sure to disconnect the standard (composite) video cable. Do not connect both types of video cable at the same time.

Picture and sound are out of sync

- As with all products that contain a digital display, in rare instances, when viewing certain content (e.g., television broadcasts, video games, DVDs), you may notice that the sound and picture are slightly out of sync. This phenomenon can be caused by various factors including, without limitation, video processing within the TV, video processing in an attached gaming system, and video processing or different compression rates used by broadcasters in their programming. You may want to try one or more of the following suggestions, which may help to reduce the effect of this phenomenon:
 - If the TV is connected to an A/V receiver that has a programmable audio delay feature, use this feature to help synchronize the sound to the picture.
 - If you notice this phenomenon only on certain TV channels, please contact your local broadcast, cable, or satellite provider to inform them of this issue.

LED indications while in reboot from standby

- When you plug the power cord in, the yellow LED will blink until the TV enters standby mode, (plugged in but not powered on). This is normal and is not a sign of malfunction.

Sound problems

- Check the antenna/cable connections (🔧 Chapter 2).
- The station may have broadcast difficulties. Try another channel.
- The sound may be muted. Press **VOLUME**.
- If you hear no sound, try setting the **MTS** feature to **Stereo** mode (🔧 page 64).
- If you are not receiving a second audio program from a known SAP source, make sure the **MTS** feature is set to **SAP** mode (🔧 page 64).
- If you hear audio that seems “incorrect” for the program you are watching (such as music or a foreign language), the SAP mode may be on. Set the **MTS** feature to **Stereo** mode (🔧 page 64).
- When using an external audio amplifier, if you connect the amplifier to the **VARIABLE AUDIO OUT** terminals, the volume of the TV and amplifier must be set above 0 or you will not hear any sound (🔧 page 22).

Remote control problems

- Make sure the remote control is set to the correct device mode (🔧 page 27).
- Remove all obstructions between the remote control and the TV.
- The remote control batteries may be dead. Replace the batteries (🔧 page 26).
- Your TV remote control may not operate certain features on your external device. Refer to the owner’s manual for your other device to determine its available features. If your TV remote control does not operate a specific feature on another device, use the remote control that came with the device (🔧 pages 31–39).
- If the TV still does not act as expected, use the Reset Factory Defaults procedure (🔧 page 49).

Channel tuning problems

- Make sure the remote control is set to the correct device mode (🔧 page 27).
- The channel may have been erased from the channel memory by the **Channel Add/Delete** feature. Add the channel to the channel memory (🔧 page 45).
- The channel may be blocked by the **Channels Block** feature. Unblock the channel (🔧 page 69).
- If you are unable to tune digital channels, check the antenna configuration (🔧 page 44). If you are still unable to tune digital channels, clear all channels from the channel list (🔧 page 45) and reprogram channels into the channel memory (🔧 page 44). If you are still unable to tune digital channels, use the Reset Factory Defaults procedure (🔧 page 49). Also see “TV stops responding to controls” and “Other problems” (🔧 page 104).

Closed caption problems

- If the program or video you selected is not closed-captioned, no captions will display (🔧 page 62).
- If text is not available, a black rectangle may appear. If this happens, turn off the closed caption feature (🔧 page 62).
- A closed-caption signal may not display correctly in the following situations: a) when a videotape has been dubbed; b) when the signal reception is weak; or c) when the signal reception is nonstandard (🔧 page 62).

Rating blocking (V-Chip) problems

- If you forget your PIN code: While the PIN code entering screen is displayed, press **RECALL** four times within 5 seconds. The PIN code you previously stored will be cleared (🔧 page 67).
- The V-Chip feature is available for the U.S. V-Chip system only (🔧 page 68).

No CE-Link operation

- The CE-Link feature is available for Toshiba CE-Link compatible devices.
- Make sure the HDMI cables with the HDMI Logo (**HDMI**) are used.
- When the connected CE-Link device does not work correctly after you have changed settings of the device, turn off your TV and unplug the power cord, then plug and turn on again.
- If several devices are connected, CE-Link feature may not operate properly.
- Read the instruction manual furnished with the connected CE-Link device.

HDMI problems

For HDMI cables

- Make sure the HDMI cables with the HDMI Logo (**HDMI**) are used (🔧 page 20).

For HDMI Deep Color™

- You should need to use Category 2 cable to work properly. Normal HDMI cable or DVI cable may not work with this option (🔧 page 75).

For Legacy HDMI source

- Some of legacy HDMI sources may not work properly with latest HDMI TV products, due to new standard adoption. Please try to set Off the HDMI settings (Lip-Sync Latency, Deep Color, xvYCC). Your legacy HDMI source should operate properly with this TV products (🔧 page 75).

Home network troubleshooting

Audio Player problems

The Audio Player stutters and/or stops when playing files over the network

- The networked PC is not available, was removed from the network, or is in “hibernation.”
- The Ethernet cables are not connected properly. Check all cables for proper connection.
- Sufficient network band-width is not available. Turn off any other file sharing programs, network-based games, or other network-intensive operations while the **Audio Player** is playing.

“No media found” message is displayed

- Sharing is not correctly set up on the networked PC. Make sure you connected your home network correctly (🔗 pages 24 and 25) and set up the network address properly (🔗 Chapter 8).
- The MP3 files exceed the specified limits (🔗 “Media specifications” in Chapter 8).

Title or artist name is not displayed

- The MP3 file does not contain valid meta-data or does not meet supported specifications (🔗 “Media specifications” in Chapter 8).

*The **Audio Player** takes almost a minute to start*

- Sufficient network band-width is not available. Turn off any other file sharing programs, network-based games, or other network-intensive operations while the **Audio Player** is playing.
- The shared folder has too many files or sub-folders. If the shared folder on the networked PC contains a large number of files or nested directories, it may take over a minute for the **Audio Player** to locate all playable files.

The File is displayed but is always skipped

- The file is not a valid or supported MP3 file.

Some files in the shared folder are not played

- Only the first 200 MP3 files found will be played. Folders nested 10 or more levels below the shared folder are not searched.

The Audio Player plays (progress bar and animation change) but audio is not heard

- The volume level is not high enough or TV is muted.

Picture Viewer problems

“No pictures found” message is displayed

- Sharing is not correctly set up on the networked PC. Make sure you connected your home network correctly (🔗 pages 24 and 25) and set up the network address properly (🔗 Chapter 8).
- The JPEG files exceed the specified limits (🔗 “Media specifications” in Chapter 8).

Picture viewer option in menu is disabled

- There are no picture files in the networked PC's shared folder(s).
- Basic network setup and Home server setup were not successfully performed.

Picture is not displayed; Rectangle containing “X” is displayed instead

- The picture file does not meet the specifications for the **Picture Viewer** (🔗 “Media specifications” in Chapter 8).

Picture is not listed at all

- There are no picture files in the networked PC's shared folder(s).
- The number of pictures files found is more than the TV can display.
- The picture file does not have a valid “.jpg” extension.
- The file is too large or is otherwise not compatible with the TV for display. See “Media specifications” in Chapter 8 for Picture Viewer and JPEG file specifications.

Basic network setup problems

Cannot connect to network

- Check the modem and splitter connections.
- Make sure the splitter is connected to the modem or telephone jack correctly (🔗 page 25).
- Confirm your modem's operation with this manual.
- Make sure your network address and e-mail account are set up correctly (🔗 Chapter 8).

No network connection

- The Ethernet cables are not connected properly or at all. Connect all cables(🔗 pages 24 and 25).
- Make sure the modem's power cord is plugged in.
- Make sure your network address and e-mail account are set up correctly (🔗 Chapter 8).

Automatic setup fails

- The Ethernet cables are not connected properly or at all. Connect all cables(🔗 pages 24 and 25).
- The DHCP service is not enabled on the router, or no router is present. Refer to your router's documentation for instructions on enabling DHCP. If you do not have a router, you must manually set up the network address (🔗 page 89).
- Internet service is not available. Check your cable/DSL modem or contact your ISP for Internet service issues.

Manual setup fails

- The Ethernet cables are not connected properly or at all. Connect all cables (🔗 pages 24 and 25).
- The TV IP address is the same as the networked PC's. The TV IP address must be different from the PC's IP address.
- The TV IP address is not on the same subnet as the networked PC's. For example, if the PC has IP 192.168.0.100 with netmask 255.255.255.0, and the TV has IP 192.168.0.200 with netmask 255.255.255.0, then they are both on same subnet. Conversely, if the PC has IP 192.168.1.100 with netmask 255.255.255.0, and the TV has IP 192.168.0.200 with netmask 255.255.255.0, then they are on different sub-nets.

Unstable network connection

- Unplug the Ethernet cables, and then connect them again.

Home server setup problems

The PC (“Home Server”) name is not displayed

- The Ethernet cables are not connected properly or at all. Connect all cables (see pages 24 and 25).
- The network setup on the PC is incorrect. Make sure both the PC and TV are using the same network type (DHCP/manual) and have compatible network settings.
- The networked PC does not have shared folders set up correctly. See “Setting up file sharing on your PC” in Chapter 8 for details.
- There are no master browsers on the network. To configure your networked PC to be the master browser of its subnet, refer to your operating system user guide or consult an IT professional.
- Too many sharing devices are connected. You cannot connect more than 16 sharing devices at one time.

The PC (“Home Server”) name is displayed but the shared folder(s) are not displayed.

- The networked PC does not have shared folders set up correctly. See “Setting up file sharing on your PC” in Chapter 8 for details.
- The TV’s user name and password do not match the PC’s. Make sure the user name and password settings in the TV exactly match the settings in the networked PC. User names and passwords are generally case sensitive.

Personal E-mail problems

Cannot receive mail

- Your e-mail settings may be incorrect. Ensure that you have POP3 e-mail service enabled with your ISP. The Personal E-mail feature does not work with web-browser-based (HTTP based) e-mail services.
- Your network settings may be incorrect. Contact your ISP.

Characters in incoming mail are not displayed properly

- The supported character encoding methods are US-ASCII, ISO-8859-1, UTF-8, ISO-2022-JP, SHIFT_JIS, and EUC-JP. No other encoding methods are supported.

Images in HTML mail are not displayed

- Depending on the type of HTML, some images may not display.

LED indications

The green and yellow LED lights on the TV front indicate the TV's status, as described below.

Note: If the TV loses A/C power (e.g., a power outage occurs or the power cord is unplugged), when power is restored, the yellow LED will blink while the TV is booting until the remote control is usable. This is normal and is not a sign of malfunction.

TV front

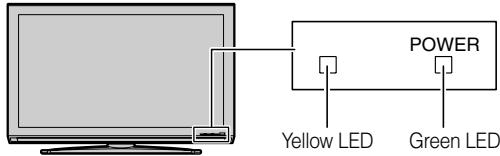

LED Indication	Condition	Solution
1) Green is ON (solid).	The TV is operating properly.	–
2) Yellow is ON (solid).	Standby with Power-On Mode set to Fast.	See “Selecting the Power-On Mode” (page 50).
3) Yellow blinks.	Fan stopped (57LX177 only).	Turn OFF the TV and unplug the power cord. Plug the power cord in again and turn ON the TV.
4) Green blinks slowly.	Abnormal operation of BUS line.	
5) Green blinks quickly.	Power protect detection.	
6) Yellow blinks three times.	TV is powering up.	Wait several seconds until the yellow LED stops blinking.
7) Green blinks slowly. Yellow blinks slowly.	Charis calibration error	Turn OFF the TV and unplug the power cord. Plug the power cord in again and turn ON the TV.

If, after trying the solutions, the problem still exists:

- In the U.S., call TACP Consumer Solutions at 1-800-575-5469.
- In Canada, locate the nearest Toshiba authorized service depot by directing your web browser to www.toshiba.ca; click “Home Entertainment,” and then click “Support.”

Specifications

Note:

- *This model complies with the specifications listed below.*
- *Designs and specifications are subject to change without notice.*
- *This model may not be compatible with features and/or specifications that may be added in the future.*

Television System

NTSC standard
 ATSC standard (8VSB)
 Digital Cable (64 QAM, 256 QAM; in-the-clear, unencrypted)

Channel Coverage

VHF: 2 through 13
 UHF: 14 through 69
 Cable TV: Mid band (A-8 through A-1, A through I)
 Super band (J through W)
 Hyper band (AA through ZZ, AAA, BBB)
 Ultra band (65 through 94, 100 through 135)

Power Source

120 V AC, 60 Hz

Power Consumption

42LX177: 188 W (average)
 0.6 W in standby mode
 46LX177: 213 W (average)
 0.4 W in standby mode
 52LX177: 232 W (average)
 0.4 W in standby mode
 57LX177: 352 W (average)
 0.3 W in standby mode

Audio Power

10 W + 10 W

Speaker Type

Two 4 inches (100 mm) round

Video/Audio Terminals

S-VIDEO INPUT:

Y: 1 V(p-p), 75 ohm, negative sync.
 C: 0.286 V(p-p) (burst signal), 75 ohm

VIDEO/AUDIO INPUT:

VIDEO: 1 V(p-p), 75 ohm, negative sync.
 AUDIO: 150 mV(rms) (30% modulation equivalent, 22 k ohm or greater)

ColorStream® (component video) HD INPUT:

VIDEO: Y: 1V(p-p), 75 ohm
 PR: 0.7 V(p-p), 75 ohm
 PB: 0.7 V(p-p), 75 ohm
 Suggested formats: 1080i, 720p, 480p, 480i
 AUDIO: 150 mV(rms), 22 k ohm or greater

HDMI™ INPUT:

HDMI compliant (type A connector)
 HDCP compliant
 E-EDID* compliant
 Audio Lip Sync supported
 Deep Color supported (10 bit 4:4:4, 12 bit 4:4:4)
 xvYCC supported
 Suggested formats: See table below.
 HDMI Audio: 2-channel Linear-PCM; 32/44.1/48 kHz sampling frequency; 16/20/24 bits per sample

FIXED AUDIO OUTPUT:

150 mV (rms) (30% modulation equivalent, 2.2 k ohm or less)

VARIABLE AUDIO OUTPUT:

0-300 mV (rms) (30% modulation equivalent, 2.2 k ohm or less)

DIGITAL AUDIO OUTPUT:

Optical type

IR IN/OUT:

3 V(p-p), 3.5 mm mono socket

PC INPUT:

15-Pin D-sub Analog RGB

RJ-45 port:

Standard Ethernet (RJ-45)

* E-EDID = Enhanced-Extended Display Identification

HDMI input supports the following signal formats:

Format	Resolution	V. Frequency	H. Frequency	Pixel Clock Frequency
VGA	640 x 480p	59.940/60Hz	31.469/31.500kHz	25.175/25.200MHz
480i	720 x 480i	59.940/60Hz	15.734/15.750kHz	27.000/27.027MHz
480p	720 x 480p	59.940/60Hz	31.469/31.500kHz	27.000/27.027MHz
720p	720 x 480p	59.940/60Hz	44.955/45.000kHz	74.176/74.250MHz
1080i	1920 x 1080i	59.940/60Hz	33.716/33.750kHz	74.176/74.250MHz
1080p	1920 x 1080p	23.976/24Hz	26.973/27.000kHz	74.176/74.250MHz
1080p	1920 x 1080p	59.940/60Hz	67.433/67.500kHz	148.352/148.500MHz

Dimensions

- 42LX177: Width: 40-1/4 inches (1,020 mm)
Height: 27-5/8 inches (699 mm)
Depth: 13-7/8 inches (352 mm)
- 46LX177: Width: 44-5/8 inches (1,132 mm)
Height: 30-1/8 inches (763 mm)
Depth: 13-7/8 inches (352 mm)
- 52LX177: Width: 50-1/2 inches (1,280 mm)
Height: 33-3/8 inches (847 mm)
Depth: 15-3/8 inches (390 mm)
- 57LX177: Width: 53-3/4 inches (1,365 mm)
Height: 35-3/8 inches (896 mm)
Depth: 15-3/8 inches (390 mm)

Mass (weight)

- 42LX177: 61.5 lbs (27.9 kg)
- 46LX177: 78.7 lbs (35.7 kg)
- 52LX177: 103.2 lbs (46.8 kg)
- 57LX177: 125.2 lbs (56.8 kg)

Operating conditions

- Temperature: 32°F - 95°F (0°C - 35°C)
- Humidity: 20 - 80% (no moisture condensation)

Supplied Accessories

- Remote control with two size “AA” alkaline batteries
- Owner’s manual (this book)
- Lead clip
Use this clip to attach the TV to a wall, pillar, or other immovable structure. See item 20 on page 3.

Limited United States Warranty

for LCD Televisions 26" and Larger

Toshiba America Consumer Products, L.L.C. ("TACP") makes the following limited warranties to original consumers in the United States.

THESE LIMITED WARRANTIES EXTEND TO THE ORIGINAL CONSUMER PURCHASER OR ANY PERSON RECEIVING THIS LCD TELEVISION AS A GIFT FROM THE ORIGINAL CONSUMER PURCHASER AND TO NO OTHER PURCHASER OR TRANSFEREE. LCD TELEVISIONS PURCHASED IN THE U.S.A. AND USED ANYWHERE OUTSIDE OF THE U.S.A., INCLUDING, WITHOUT LIMITATION, CANADA AND MEXICO, ARE NOT COVERED BY THESE WARRANTIES.

LCD TELEVISIONS PURCHASED ANYWHERE OUTSIDE OF THE U.S.A., INCLUDING, WITHOUT LIMITATION, CANADA AND MEXICO, AND USED IN THE U.S.A., ARE NOT COVERED BY THESE WARRANTIES.

Limited One (1) Year Warranty on Parts and Labor

TACP warrants this LCD Television and its parts against defects in materials or workmanship for a period of one (1) year after the date of original retail purchase. DURING THIS PERIOD, TACP WILL, AT TACP'S OPTION, REPAIR OR REPLACE A DEFECTIVE PART WITH A NEW OR REFURBISHED PART WITHOUT CHARGE TO YOU FOR PARTS OR LABOR. During this period, TACP Authorized Service Station personnel will come to your home when warranty service is required. Depending on the type of repair required, the service will either be performed in your home or the LCD Television will be taken to a TACP Authorized Service Station for repair and returned to your home at no cost to you.

Rental Units

The warranty for LCD Television rental units begins on the date of the first rental or thirty (30) days after the date of shipment to the rental firm, whichever comes first.

Limited Warranty for Commercial Units

TACP warrants LCD Televisions that are sold and used for commercial purposes as follows: all parts are warranted against defects in materials or workmanship for a period of ninety (90) days after the date of original retail purchase. DURING THIS PERIOD, TACP WILL, AT TACP'S OPTION, REPAIR OR REPLACE A DEFECTIVE PART WITH A NEW OR REFURBISHED PART WITHOUT CHARGE TO YOU.

Owner's Manual and Product Registration Card

Read this owner's manual thoroughly before operating this LCD Television.

Complete and mail the enclosed product registration card or register your LCD Television online at www.tacp.toshiba.com/service as soon as possible. By registering your LCD Television you will enable TACP to bring you new products specifically designed to meet your needs and help us to contact you in the unlikely event a safety notification is required under the U.S. Consumer Product Safety Act. **Failure to complete and return the product registration card does not diminish your warranty rights.**

Your Responsibility

THE ABOVE WARRANTIES ARE SUBJECT TO THE FOLLOWING CONDITIONS:

- (1) You must retain your original bill of sale or provide other proof of purchase.
- (2) All warranty servicing of this LCD Television must be performed by an Authorized TACP Service Station.
- (3) The warranties from TACP are effective only if this LCD Television is purchased and operated in the Continental U.S.A. or Puerto Rico.
- (4) Labor service charges for set installation, setup, adjustment of customer controls, and installation or repair of antenna systems are not covered by this warranty. Reception problems caused by inadequate antenna systems, misaligned satellite dishes, cable

television distribution, VCRs, DVD players/recorders, personal computer level IEEE-1394 devices, and any other connected signal source device are your responsibility.

- (5) Warranties extend only to defects in materials or workmanship as limited above, and do not extend to any LCD Television or parts that have been lost or discarded by you or to damage to the LCD Television or parts caused by fires, misuse, accident, Acts of God (such as lightning or fluctuations in electric power), improper installation, improper maintenance, or use in violation of instructions furnished by TACP; use or malfunction through simultaneous use of this LCD Television and connected equipment; or to units that have been modified or had the serial number removed, altered, defaced, or rendered illegible.

How to Obtain Warranty Service

If, after following all of the operating instructions in this manual and reviewing the section entitled "Troubleshooting," you find that service is needed:

- (1) To find the nearest TACP Authorized Service Station, visit TACP's website at www.tacp.toshiba.com/service or contact TACP's Consumer Solution Center toll free at 1-800-575-5469.
- (2) You must present your original bill of sale or other proof of purchase to the TACP Authorized Service Station.

**For additional information, visit TACP's website:
www.tacp.toshiba.com**

ALL WARRANTIES IMPLIED BY THE LAW OF ANY STATE OF THE U.S.A., INCLUDING THE IMPLIED WARRANTIES OF MERCHANTABILITY AND FITNESS FOR A PARTICULAR PURPOSE, ARE EXPRESSLY LIMITED TO THE DURATION OF THE LIMITED WARRANTIES SET FORTH ABOVE. WITH THE EXCEPTION OF ANY WARRANTIES IMPLIED BY THE LAW OF ANY STATE OF THE U.S.A. AS HEREBY LIMITED, THE FOREGOING WARRANTY IS EXCLUSIVE AND IN LIEU OF ALL OTHER WARRANTIES, GUARANTEES, AGREEMENTS, AND SIMILAR OBLIGATIONS OF TACP WITH RESPECT TO THE REPAIR OR REPLACEMENT OF ANY PARTS. IN NO EVENT SHALL TACP BE LIABLE FOR CONSEQUENTIAL OR INCIDENTAL DAMAGES (INCLUDING, BUT NOT LIMITED TO, LOST PROFITS, BUSINESS INTERRUPTION, OR MODIFICATION OR ERASURE OF RECORDED DATA CAUSED BY USE, MISUSE OR INABILITY TO USE THIS LCD TELEVISION).

No person, agent, distributor, dealer, or company is authorized to change, modify, or extend the terms of these warranties in any manner whatsoever. The time within which an action must be commenced to enforce any obligation of TACP arising under the warranty or under any statute or law of the United States or any state thereof is hereby limited to ninety (90) days from the date you discover, or should have discovered, the defect. This limitation does not apply to implied warranties arising under the law of any state of the U.S.A.

THIS WARRANTY GIVES YOU SPECIFIC LEGAL RIGHTS AND YOU MAY ALSO HAVE OTHER RIGHTS WHICH MAY VARY FROM STATE TO STATE IN THE U.S.A. SOME STATES OF THE U.S.A. DO NOT ALLOW LIMITATIONS ON THE DURATION OF AN IMPLIED WARRANTY, WHEN AN ACTION MAY BE BROUGHT, OR THE EXCLUSION OR LIMITATION OF INCIDENTAL OR CONSEQUENTIAL DAMAGES. THEREFORE, THE ABOVE PROVISIONS MAY NOT APPLY TO YOU UNDER SUCH CIRCUMSTANCES.

Limited Canadian Warranty for Toshiba Brand Flat Panel Televisions

Toshiba of Canada Limited ("TCL") makes the following limited warranties to original consumers in Canada. THESE LIMITED WARRANTIES EXTEND TO THE ORIGINAL CONSUMER PURCHASER OR ANY PERSON RECEIVING THIS TOSHIBA BRAND FLAT PANEL TELEVISION (the "TELEVISION(S)" or "Television(s)") AS A GIFT FROM THE ORIGINAL CONSUMER PURCHASER AND TO NO OTHER PURCHASER OR TRANSFEREE.

TELEVISIONS PURCHASED IN CANADA, AND USED ANYWHERE OUTSIDE OF CANADA INCLUDING, WITHOUT LIMITATION, THE UNITED STATES AND MEXICO, ARE NOT COVERED BY THESE WARRANTIES.

TELEVISIONS PURCHASED ANYWHERE OUTSIDE OF CANADA, INCLUDING, WITHOUT LIMITATION, THE UNITED STATES AND MEXICO, AND USED IN CANADA, ARE NOT COVERED BY THESE WARRANTIES.

Limited One (1) Year Warranty on Parts and Labour

Subject to the more limited warranty if the Television is used for any commercial or business purposes as set out below, TCL warrants the Television and its parts against material defects in materials or workmanship that result in the Television failing for a period of one (1) year after the date of original retail purchase. DURING THIS PERIOD, TCL WILL, AT TCL'S OPTION, REPAIR OR REPLACE A DEFECTIVE PART WITH A NEW OR REFURBISHED PART WITHOUT CHARGE TO YOU FOR PARTS OR LABOUR.

- (a) FOR TELEVISIONS 32 INCHES OR LESS: YOU MUST DELIVER THE ENTIRE TELEVISION TO A TCL TELEVISION AUTHORIZED SERVICE PROVIDER ("ASP"). YOU MUST PAY FOR ALL TRANSPORTATION AND INSURANCE CHARGES FOR THE TELEVISION TO AND FROM THE ASP.
- (b) FOR TELEVISIONS OVER 32 INCHES: During this period, ASP personnel will come to your home when warranty service is required. Depending on the type of repair required, the service will either be performed in your home or the Television will be taken to an ASP for repair and returned to your home at no cost to you. **IN-HOME SERVICE ONLY APPLIES WITHIN 100 KILOMETERS OF AN ASP. IF YOU ARE NOT WITHIN 100 KILOMETERS OF AN ASP, YOU MUST DELIVER THE ENTIRE TELEVISION TO AN ASP. YOU MUST PAY FOR ALL TRANSPORTATION AND INSURANCE CHARGES FOR THE TELEVISION TO AND FROM THE ASP.**

Limited Warranty for Commercial Units

TCL warrants Televisions that are used for any commercial or business purposes as follows: all parts are warranted against material defects in materials or workmanship that result in the Television failing for a period of ninety (90) days after the date of original retail purchase. DURING THIS PERIOD, TCL WILL, AT TCL'S OPTION, REPAIR OR REPLACE THE DEFECTIVE PART WITH A NEW OR REFURBISHED PART WITHOUT CHARGE TO YOU.

- (c) FOR TELEVISIONS 32 INCHES OR LESS: YOU MUST DELIVER THE ENTIRE TELEVISION TO AN ASP. YOU MUST PAY FOR ALL TRANSPORTATION AND INSURANCE CHARGES FOR THE TELEVISION TO AND FROM THE ASP.

- (d) FOR TELEVISIONS OVER OVER 32 INCHES: During this period, ASP personnel will come on-site when warranty service is required. Depending on the type of repair required, the service will either be performed on-site or the Television will be taken to an ASP for repair and returned at no cost to you. **ON-SITE SERVICE ONLY APPLIES WITHIN 100 KILOMETERS OF AN ASP. IF YOU ARE NOT WITHIN 100 KILOMETERS OF AN ASP, YOU MUST DELIVER THE ENTIRE TELEVISION TO AN ASP. YOU MUST PAY FOR ALL TRANSPORTATION AND INSURANCE CHARGES FOR THE TELEVISION TO AND FROM THE ASP.**

Rental Units

The warranty for Television rental units begins with the date of first rental or thirty (30) days from the date of shipment to the rental firm, whichever comes first.

Your Responsibility

THE ABOVE WARRANTIES ARE SUBJECT TO THE FOLLOWING CONDITIONS:

- (1) You must provide your bill of sale or other proof of purchase.
- (2) All warranty servicing of this Television must be performed by an ASP.
- (3) The warranties from TCL are effective only if the Television is (i) purchased as new and unopened from TCL or from TCL's authorized distributors, dealers or resellers ("ADR's") and (ii) located/operated in Canada.
- (4) Labour charges for set installation, setup, adjustment of customer controls, and installation or repair of antenna systems are not covered by these warranties. Reception problems caused by inadequate antenna systems are your responsibility.
- (5) Warranties extend only to material defects in materials or workmanship as limited above, and do not extend to:
 - a. Service, repairs or replacement made necessary by accident, misuse, abuse, moisture, liquids, dust, dirt, neglect, accident, damage, 24/7 applications, improper installation, improper operation, improper cleaning, improper maintenance, normal wear and tear, screen burn or image retention caused by prolonged display of static images and/or phosphor aging, or any other external cause or event, act or omission outside the control of TCL, including fire, theft, acts of God, alteration, power failures, power surges or power shortages, lightning, other electrical faults, or repairs, modifications or replacements by persons other than those authorized by TCL to service the Television;
 - b. Replacement of missing, discarded or lost parts, the provision of retrofits, or preventive maintenance;
 - c. Repair of damage that is cosmetic only or does not affect the Television functionality, such as wear and tear, scratches and dents;
 - d. Service on Toshiba-branded accessory items (such accessory items may be covered by their own warranty);
 - e. Service on third party products or service made necessary by use of incompatible third party products;
 - f. Service made necessary by the simultaneous use of this Television and connected equipment;
 - g. Modifications to the Television not approved in writing by TCL, and service made necessary by the use or installation of non-Toshiba modifications to the Television;
 - h. Service of a Television on which the TOSHIBA label or logo, rating label or serial number have been defaced or removed;
 - i. On-site service and repair of the Television; and
 - j. Damage to the Television caused by failure to follow the specifications, User manuals or guides as to usage and/or storage.

Disclaimer and Limitation of Remedy

TO THE EXTENT NOT PRECLUDED BY LAW, ALL OTHER EXPRESS AND IMPLIED WARRANTIES, CONDITIONS AND REPRESENTATIONS FOR THIS TELEVISION, INCLUDING THE IMPLIED WARRANTIES, CONDITIONS AND REPRESENTATIONS OF MERCHANTABILITY AND FITNESS FOR A PARTICULAR PURPOSE, ARE HEREBY DISCLAIMED AND EXCLUDED. IF THE APPLICABLE LAW, STATUTORY OR OTHERWISE, PRECLUDES THE EXCLUSION OF ANY IMPLIED WARRANTIES, CONDITIONS AND REPRESENTATIONS THEN SUCH IMPLIED WARRANTIES, CONDITIONS AND REPRESENTATIONS ARE OTHERWISE LIMITED IN DURATION TO THE TERM OF THIS EXPRESS WRITTEN LIMITED WARRANTY. TO THE EXTENT NOT PRECLUDED BY LAW, STATUTORY OR OTHERWISE, THIS WRITTEN WARRANTY SUPERCEDES AND SPECIFICALLY DISCLAIMS ANY OTHER WARRANTY, CONDITION OR REPRESENTATION NOT STATED IN THIS WARRANTY, WHETHER MADE BY TCL, TOSHIBA CORPORATION, THEIR AFFILIATES, ADRs AND ASPs AND WHETHER MADE ORALLY OR IN WRITING (INCLUDING ANY STATEMENT IN ANY BROCHURE, PRESS RELEASE, ANNOUNCEMENT, ADVERTISEMENT, POINT OF SALE DISPLAY, ETC.).

YOU MUST READ AND FOLLOW ALL SET-UP AND USAGE INSTRUCTIONS IN THE APPLICABLE USER GUIDES AND/OR MANUALS. IF YOU FAIL TO DO SO, THIS TELEVISION MAY NOT FUNCTION PROPERLY AND YOU MAY SUFFER DAMAGE. THIS WARRANTY WILL NOT COVER ANY SERVICE THAT IS REQUIRED, IN PART OR IN WHOLE, AS A RESULT OF ANY FAILURE TO FOLLOW THE SET-UP AND USAGE INSTRUCTIONS. THIS WARRANTY DOES NOT APPLY AND SHALL BE VOID AND UNENFORCEABLE IF THE TELEVISION IS OPENED, SERVICED, OR REPAIRED BY PERSONS OTHER THAN THOSE AUTHORIZED BY TCL TO SERVICE OR REPAIR THE TELEVISION.

IF THE TELEVISION FAILS TO WORK AS WARRANTED ABOVE, YOUR SOLE AND EXCLUSIVE REMEDY SHALL BE REPAIR OR REPLACEMENT OF THE DEFECTIVE PART. IN NO EVENT WILL TCL, TOSHIBA CORPORATION, THEIR AFFILIATES, ADRs OR ASPs (THE "RELATED PARTIES") BE LIABLE TO YOU OR ANY THIRD PARTY FOR ANY DAMAGES, MONEY, REIMBURSEMENT, COSTS OR EXPENSES. THIS LIMITATION APPLIES TO DAMAGES, MONEY, REIMBURSEMENT, COSTS OR EXPENSES OF ANY KIND WHATSOEVER INCLUDING ANY DIRECT OR INDIRECT DAMAGES, DAMAGE TO PROPERTY OR PERSON, LOST PROFITS, LOST SAVINGS, INCONVENIENCE OR OTHER SPECIAL, INCIDENTAL, EXEMPLARY OR CONSEQUENTIAL DAMAGES, WHETHER FOR BREACH OF WARRANTY, BREACH OF CONTRACT, TORT (INCLUDING NEGLIGENCE), UNDER A STATUTE OR UNDER ANY OTHER LAW OR FORM OR ACTION, OR WHETHER ARISING OUT OF THE USE OF OR INABILITY TO USE THE TELEVISION, EVEN IF ANY OF THE RELATED PARTIES HAS BEEN ADVISED OF THE POSSIBILITY OF SUCH DAMAGES OR OF ANY CLAIM BY ANY OTHER PARTY.

No person, agent, distributor, dealer or company is authorized to change, modify or extend the terms of these warranties in any manner whatsoever.

Arbitration and Dispute Resolution

To the extent not precluded by law, any claim, dispute, controversy or disagreement (whether for breach of warranty, breach of contract, tort (including negligence), under a statute or under any other law or form of action) against any of the Related Parties arising out of, or otherwise relating to: (i) this warranty; (ii) the Television; (iii) any oral or written representations, statements, brochures, press releases, advertising, announcement, point of sale display, or promotional material relating to the Television; (iv) the relationships that result from this warranty, (the foregoing claims, disputes controversies and disagreements are collectively referred to as the "Dispute"), shall be referred to and resolved by final and binding arbitration (to the exclusion of the courts). To the extent not precluded by law, you agree to waive any right that you may have to commence or participate in any representative or class proceeding against the Related Parties relating to any Dispute. If and where applicable and to the extent not precluded by law, you further

agree to opt out of any such representative or class proceedings. Arbitration of any Dispute will be conducted in the forum and in the manner as agreed to between you and TCL. Failing such agreement, the arbitration will be conducted by one arbitrator pursuant to the laws and rules relating to arbitration generally in force in the jurisdiction in which you reside at the time that the Dispute arises. To the extent not precluded by law, no claim, dispute, controversy or disagreement of any other person may be joined or combined with any Dispute by you, without the prior written consent of TCL.

Critical Applications

The Television you have purchased is not designed for any "critical applications." "Critical applications" means life support systems, medical applications, connections to implanted medical devices, commercial transportation, nuclear facilities or systems or any other applications where Television failure could lead to injury to persons or loss of life or catastrophic property damage.

IF THE CUSTOMER USES THE TELEVISION IN ANY CRITICAL APPLICATION, THE CUSTOMER - AND NOT TCL, ITS AFFILIATES, ADRs OR ASPs - ASSUME SOLE AND FULL RESPONSIBILITY FOR SUCH USE. TCL RESERVES THE RIGHT TO REFUSE TO SERVICE ANY TELEVISION USED IN A CRITICAL APPLICATION. TCL, ITS AFFILIATES, ADRs AND ASPs HEREBY DISCLAIM ANY AND ALL LIABILITY, DAMAGES AND CONSEQUENCES ARISING OUT OF THE SERVICE OR REFUSAL TO SERVICE SUCH TELEVISION AND FURTHER DISCLAIM ANY AND ALL LIABILITY, CONSEQUENCES AND DAMAGES THAT MAY ARISE OR RESULT FROM THE USE OF THE TELEVISION IN ANY CRITICAL APPLICATIONS.

General Provisions

If and to the extent that any provision of this limited warranty should generally be found to be unenforceable, the unenforceable provision shall be severed from the warranty and deemed not to form part of the warranty. The remaining provisions of this warranty shall be and remain valid and enforceable. If and to the extent that any provision of this limited warranty as it relates to any of the Related Parties is found to be invalid or unenforceable in respect of that party (the "Excluded Party"), the Excluded Party shall be deemed to be severed or excluded from the provision, and the provision shall remain valid, enforceable and applicable in respect of the other or remaining Related Parties.

To the extent permitted by law, this limited warranty shall be governed and construed in accordance with the laws of Ontario.

If there is any inconsistency between this limited warranty, on the one hand, and any statement in the packaging of the Television or in any other document enclosed with, or used in the context of the promotion or sale of, the Television, on the other hand, the provisions of this limited warranty shall prevail.

How to Obtain Warranty Services

If, after following all of the operating instructions in this manual and checking the "Troubleshooting" section, you find that service is needed:

- (1) To find the nearest ASP, visit TCL's web site at www.toshiba.ca, or call toll free 1-800-268-3404
- (2) Present your bill of sale or other proof of purchase to the ASP.

For additional information, visit TCL's website at www.toshiba.ca

A copy of the GPL source code in this product may be obtained by contacting Toshiba Consumer Solutions at (800)631-3811. There will be a charge to cover the costs of providing the source code.

A copy of the LGPL source code in this product may be obtained by contacting Toshiba Consumer Solutions at (800)631-3811. There will be a charge to cover the costs of providing the source code.

USB Protocol Copyright © 2005 The NetBSD Foundation, Inc. All rights reserved.

Redistribution and use in source and binary forms, with or without modification, are permitted provided that the following conditions are met:

- (1) Redistributions of source code must retain the above copyright notice, this list of conditions and the following disclaimer.
- (2) Redistributions in binary form must reproduce the above copyright notice, this list of conditions and the following disclaimer in the documentation and/or other materials provided with the distribution.
- (3) Neither the name of The NetBSD Foundation nor the names of its contributors may be used to endorse or promote products derived from this software without specified prior written permission.

THIS SOFTWARE IS PROVIDED BY THE NETBSD FOUNDATION, INC. AND CONTRIBUTORS "AS IS" AND ANY EXPRESS OR IMPLIED WARRANTIES, INCLUDING, BUT NOT LIMITED TO, THE IMPLIED WARRANTIES OF MERCHANTABILITY AND FITNESS FOR A PARTICULAR PURPOSE ARE DISCLAIMED. IN NO EVENT SHALL THE FOUNDATION OR CONTRIBUTORS BE LIABLE FOR ANY DIRECT, INDIRECT, INCIDENTAL, SPECIAL, EXEMPLARY, OR CONSEQUENTIAL DAMAGES (INCLUDING, BUT NOT LIMITED TO, PROCUREMENT OF SUBSTITUTE GOODS OR SERVICES; LOSS OF USE, DATA, OR PROFITS; OR BUSINESS INTERRUPTION) HOWEVER CAUSED AND ON ANY THEORY OF LIABILITY, WHETHER IN CONTRACT, STRICT LIABILITY, OR TORT (INCLUDING NEGLIGENCE OR OTHERWISE) ARISING IN ANY WAY OUT OF THE USE OF THIS SOFTWARE, EVEN IF ADVISED OF THE POSSIBILITY OF SUCH DAMAGE.

This product includes software developed by the OpenSSL Project for use in the OpenSSL Toolkit (<http://www.openssl.org>).

This product includes cryptographic software written by Eric Young (ey@cryptsoft.com).

OpenSSL 0.9.7d Copyright © 1998-2000 the OpenSSL Project. All Rights reserved. Redistribution and use in source and binary forms, with or without modification, are permitted provided that the following conditions are met:

- (1) Redistributions of source code must retain the above copyright notice, this list of conditions and the following disclaimer.
- (2) Redistributions in binary form must reproduce the above copyright notice, this list of conditions and the following disclaimer in the documentation and/or other materials provided with the distribution.
- (3) All advertising materials mentioning features or use of this software must display the following acknowledgement: This product includes software developed by the OpenSSL Project for use in the OpenSSL Toolkit (<http://openssl.org>).
- (4) The names "OpenSSL Toolkit" and "Open SSL Project" must not be used to endorse or promote products derived from this software without prior written permission. For written permission, please contact openssl-core@openssl.org.
- (5) Products derived from this software may not be called "OpenSSL" nor may "Open SSL" appear in their names without prior written permission of the OpenSSL Project.
- (6) Redistributions of any form whatsoever must retain the following acknowledgement: "This product includes software developed by the OpenSSL Project for use in the OpenSSL Toolkit (<http://www.openssl.org>)."

THIS SOFTWARE IS PROVIDED BY THE OpenSSL PROJECT "AS IS" AND ANY EXPRESSED OR IMPLIED WARRANTIES, INCLUDING, BUT NOT LIMITED TO, THE IMPLIED WARRANTIES OF MERCHANTABILITY AND FITNESS FOR A PARTICULAR PURPOSE ARE DISCLAIMED. IN NO EVENT SHALL THE OpenSSL PROJECT OR CONTRIBUTORS BE LIABLE FOR ANY DIRECT, INDIRECT, INCIDENTAL, SPECIAL, EXEMPLARY, OR CONSEQUENTIAL DAMAGES (INCLUDING, BUT NOT LIMITED TO, PROCUREMENT OF SUBSTITUTE GOODS OR SERVICES; LOSS OF USE, DATA, OR PROFITS; OR BUSINESS INTERRUPTION) HOWEVER CAUSED AND ON ANY THEORY OF LIABILITY, WHETHER IN CONTRACT, STRICT LIABILITY, OR TORT (INCLUDING NEGLIGENCE OR OTHERWISE) ARISING IN ANY WAY OUT OF THE USE OF THIS SOFTWARE, EVEN IF ADVISED OF THE POSSIBILITY OF SUCH DAMAGE. This product includes cryptographic software written by Eric Young (ey@cryptsoft.com). This product includes software written by Tim Hudson (tjh@cryptsoft.com).

Copyright © 1995-1998 Eric Young (ey@cryptsoft.com). All Rights reserved. This package is an SSL implementation written by Eric Young (ey@cryptsoft.com). The implementation was written so as to conform with Netscapes SSL. This library is free for commercial and non-commercial use so long as the following conditions are adhered to. The following conditions apply to all code found in this distribution, be it the RC4, RSA, Ihash, DES, etc., code; not just the SSL code. The SSL documentation included with this distribution is covered by the same copyright terms except that the holder is Tim Hudson (tjh@cryptsoft.com). Copyright remains Eric Young's, and as such any Copyright notices in the code are not to be removed. If this package is used in a product, Eric Young should be given attribution as the author of the parts of the library used. This can be in the form of a textual message at program startup or in documentation (online or textual) provided with the package.

Redistribution and use in source and binary forms, with or without modification, are permitted provided that the following conditions are met:

- (1) Redistributions of source code must retain the copyright notice, this list of conditions and the following disclaimer.
- (2) Redistributions in binary form must reproduce the above copyright notice, this list of conditions and the following disclaimer in the documentation and/or other materials provided with the distribution.
- (3) All advertising materials mentioning features or use of this software must display the following acknowledgement: "This product includes cryptographic software written by Eric Young (ey@cryptsoft.com)." The word 'cryptographic' can be left out if the routines from the library being used are not cryptographic related.
- (4) If you include any Windows specific code (or derivative thereof) from the apps directory (application code) you must include an acknowledgement: "This product includes software written by Tim Hudson (tjh@cryptsoft.com)."

THIS SOFTWARE IS PROVIDED BY ERIC YOUNG "AS IS" AND ANY EXPRESS OR IMPLIED WARRANTIES, INCLUDING, BUT NOT LIMITED TO, THE IMPLIED WARRANTIES OF MERCHANTABILITY AND FITNESS FOR A PARTICULAR PURPOSE ARE DISCLAIMED. IN NO EVENT SHALL THE AUTHOR OR CONTRIBUTORS BE LIABLE FOR ANY DIRECT, INDIRECT, INCIDENTAL, SPECIAL, EXEMPLARY, OR CONSEQUENTIAL DAMAGES (INCLUDING, BUT NOT LIMITED TO, PROCUREMENT OF SUBSTITUTE GOODS OR SERVICES; LOSS OF USE, DATA, OR PROFITS; OR BUSINESS INTERRUPTION) HOWEVER CAUSED AND ON ANY THEORY OF LIABILITY, WHETHER IN CONTRACT, STRICT LIABILITY, OR TORT (INCLUDING NEGLIGENCE OR OTHERWISE) ARISING IN ANY WAY OUT OF THE USE OF THIS SOFTWARE, EVEN IF ADVISED OF THE POSSIBILITY OF SUCH DAMAGE. The license and distribution terms for any publicly available version or derivative of this code cannot be changed, i.e. this code cannot simply be copied and put under another distribution license (including the GNU Public License).

Index

- A**
- Antenna cable 14
 - Antenna input configuration 44
 - Audio player 98
 - Audio quality adjustments 65
 - Audio system connection 22
 - Auto aspect 58
 - Auto Input 46
 - Auto power off 76
- B**
- Back of the TV 12
 - Base closed captions 62
 - Blocking channels 69
- C**
- C (CLOSED). CAPTION button 63
 - Cable box connection 16
 - Cable modem 25
 - CableClear® 80
 - Camcorder connection 19
 - CE-Link connection 21
 - CE-Link feature 73
 - CH ▲▼ buttons 27, 55
 - CH RTN button 27, 55
 - Channel Browser Setup 53
 - Channel Browser™ 53
 - Channel labeling 47
 - Channel Number buttons 27, 55
 - Channel programming
 - Automatic programming 44
 - Manually adding and deleting... 45
 - Cinema mode 79
 - ClearFrame™ 79
 - Closed captions 62
 - Color temperature 78
 - ColorMaster™ Pro 81
 - ColorStream® 17
 - Component video 17
 - Component video cables 14
 - Connecting cables 14
- D**
- Deep Color 75
 - Demo mode 43, 50
 - Device codes table 33
 - Digital Audio Out 22
 - Digital audio selector 64
 - Digital CC Settings 63
 - Digital signal meter 49
 - Dolby Digital 22
 - Dolby Digital Dynamic Range
 - Control 66
 - Dolby Virtual and SRS TruSurround 84
 - Double-window POP feature 59
 - DSL modem 25
 - DVD player connection 17
 - DVI connection 20
 - DynaLight™ 61
 - Dynamic contrast 77
- E**
- Ethernet (RJ-45) cable 14
- F**
- Features, TV 9
 - Film Stabilization 80
 - FREEZE 59
 - Front of the TV 11
- G**
- Game Mode feature 83
 - GameTimer® 71
- H**
- HDMI audio mode 48
 - HDMI cable 14
 - HDMI settings 75
 - Deep Color 75
 - Lip-Sync Latency 75
 - xvYCC 75
 - HDMI™ connection 20
 - Help feature 85
 - Home file server setup 93
 - Home network connection 24
- I**
- INFO button 76
 - INPUT button 51
 - Installation, care, and service 3
 - Installation, setup 10
 - Integrated digital tuning 9
 - Internet service provider 87
 - IR blaster 18
 - IR OUT connection 18
- J**
- JPEG 95
- L**
- Labeling video input 52
 - Language selection 43
 - Last mode memory feature 76
 - LED indications 11, 108
 - Lip-Sync Latency 75
- LOCKS menu
- Channels, blocking 69
 - Enable rating blocking 68
 - New PIN code 67
 - Panel lock 71
 - Unlocking programs
 - temporarily 70
 - Video inputs, locking 70
- Locks menu 67
- M**
- MODE SELECT 27, 31
 - MP3 95, 98
 - MPEG noise reduction 81
 - MTS feature 64
 - MUTE button 64
- N**
- Network address, setup 88
- O**
- Optical audio cable 14
 - Optical audio output format 66
- P**
- PC Audio 72
 - PC connection 23
 - PC settings 72
 - Personal E-mail feature 102
 - Personal E-mail setup 99
 - Picture adjustment 60
 - Picture mode 60
 - Picture quality 61
 - Picture scroll 58
 - Picture size selection 56
 - Picture Viewer 95, 96
 - POP button 59
 - POP3 Password 101
 - POWER button 11, 27
 - Power-On Mode 50
- R**
- RECALL button 76
 - Remote control
 - Battery installation 26
 - Effective range 26
 - Learning about the buttons 27
 - Operational feature 32
 - Volume lock feature 32
 - Reset Factory Defaults 49
 - RJ-45 (THINC™) connection 24
 - Router 25

(continued)

S

Safety	2
SAP sound	64
Satellite receiver connection	17
Scroll settings	58
Selecting Menu Language	43
Service	4
Setting up file sharing	90
Side panel control	11
Sleep timer	73
Slide show	97
Speaker On/Off	66
Specifications	109
StableSound®	65
Stereo sound	64
SurfLock™	55
S-video cable	14
System status	49

T

TheaterLock™ feature	61
TheaterWide® picture size	56
THINC button	27
THINC™ system	13
Troubleshooting	104
TV status information	76

V

V-Chip blocking (Locks menu)	67
VCR connection	15, 16, 17
Vertical Edge Enhancer	78
Video cables	14
Video input label	52
Video input lock	70

W

Warranty	
Canada	112
U.S.	111
WOW:SRS 3D	84
WOW:SRS Focus	84
WOW:SRS TruBass	84

X

xvYCC Selection	83
-----------------------	----

Notes

TOSHIBA AMERICA CONSUMER PRODUCTS, L.L.C.

Corporate Headquarters: 82 TOTOWA ROAD, WAYNE, NJ 07470, U.S.A.

NATIONAL SERVICE DIVISION: 1420-B TOSHIBA DRIVE, LEBANON, TN 37087, U.S.A.

TOSHIBA OF CANADA LTD.

HEAD OFFICE: 191 McNABB STREET, MARKHAM, ONTARIO, L3R 8H2, CANADA – TEL: (905) 470-5400

SERVICE CENTERS:

TORONTO: 191 McNABB STREET, MARKHAM, ONTARIO L3R 8H2, CANADA – TEL: (905) 470- 5400

MONTREAL: 18050 TRANS CANADA, KIRKLAND, QUEBEC, H9J 4A1, CANADA – TEL: (514) 390-7766

VANCOUVER: 13551 COMMERCE PARKWAY, SUITE 110, RICHMOND, B.C., V6V 2L1, CANADA – TEL: (604) 303-2500

MANUFACTURED BY

TOSHIBA ELECTROMEX, S.A. DE C.V.

CableClear, Cinema Series, ColorStream, GameTimer, StableSound, and TheaterWide are registered trademarks of Toshiba America Consumer Products, L.L.C. Channel Browser, SurfLock, DynaLight, ColorMaster, ClearFrame, TheaterLock, and THINC are trademarks of Toshiba America Consumer Products, L.L.C. REGZA is a trademark of Toshiba Corporation.

PRINTED IN USA
(07-05)

TOSHIBA